

# 1.7.1 Filtri Nafta

Fuel Filters



## Ricambi & accessori per macchine agricole

SPARE PARTS & ACCESSORIES FOR AGRICULTURAL MACHINE

Tutti gli articoli della presente sezione, prodotti da AMA SPA e/o da terzi per conto di AMA, sono adattabili ("non originali") alle marche indicate ai sensi di quanto previsto dal REG. CE n. 1400/2002. I diritti sui marchi citati appartengono ai legittimi proprietari e il loro uso ha l'esclusiva finalità di consentire all'utilizzatore la comparazione dei diversi prodotti. All items of this section, manufactured by AMA SPA and/or any third party on behalf of AMA, are adaptable ("non-original") to the brands listed under the provisions of the REG. CE n. 1400/2002. The rights on the trademarks belong to their respective owners and their usage is only aimed to allow the user to compare different products.

**FILTRI NAFTA ADATTABILI**

FILTRE A GAZOLE ADAPTABLE

FUEL FILTERS ADAPTABLE

KRAFTSTOFF FILTER PASSEND ZU

FILTRO GASOIL ADAPTABLE

Art./Ref.	Brand	Applicazione/Application	Rif. Orig./Orig. Ref.	Immagine/Image
02042	CASE	2500SP-3000SP IRRORATRICE, 4391-4391T-4391TA-6991T-6591TA, 8825-8825HP ANDANATRICE SEMOV., 8860-8860HP ANDANATRICE SEMOV., 8870 ANDANATRICE SEMOVENTE, 8880-8880HP ANDANATRICE SEMOV., MX100-MX110-MX120-MX135, MX150-MX170, SPX3200-SX3200B IRRORATRICE	J931062	
02042		955C, F100, F100DT, F110, F110DT, F115, F115DT, F120, F120DT, F130, F130DT, F140, F140DT, SERIE 55 95.55C, SERIE 65 55.65C, SERIE 66 60.65C, SERIE 66 55.66, SERIE 66 55.66/LP, SERIE 66 50.66, SERIE 66 60.66/LP, SERIE 66 55.66, SERIE 66 60.66, SERIE 66 45.66, SERIE 66 55.66/LP, SERIE 66 50.66, SERIE 75 55.75C, SERIE 75 60.75C, SERIE 76 45.76/V, SERIE 76 60.76/F, SERIE 85 55.85C, SERIE 85 60.85C, SERIE 85 62.85C, SERIE 86 70.86/V, SERIE 86 72.86/F, SERIE 86 82.86/LP-F, SERIE 86 50.86/V, SERIE 86 55.86/VF, SERIE 86 60.86/VF, SERIE 86 62.86/F, SERIE 88 55.88, SERIE 88 60.88, SERIE 90 110.90, SERIE 90 100.90, SERIE 90 90.90, SERIE 93 60.93, SERIE 94 60.94, SERIE G G170, SERIE G G190, SERIE G G210, SERIE G G240	1909142, 1930010, 47135706, 4753103, 4814454, 79075882, 87800220, 87840509	
02043		100C, 120C, 1300 - 1300C DT, 130C, 1355C, 150C, 1580 - 1580 DT, 160-90, 160-90 DT, 180, 180-90, 180-90 DT, 1880 - 1880DT, 200C, 60CA, 650 - 650DT - 655C, 655C, 750 - 750N - 750SOM - 750C, 80R, 850 - 850DT - 850SPECIAL, SERIE 50 OM	1909103, 4964322	
02058		35.66, 35.66DT	1930820, 1930891, 9963446	
02731	FIAT	3300 MIETITREBBIA LAVERDA, 3300AL MIETITREBBIA LAVERDA, 3300R MIETITREBBIA LAVERDA, 3400 MIETITREBBIA LAVERDA, 3400R MIETITREBBIA LAVERDA, 3500 MIETITREBBIA LAVERDA, 3500AL MIETITREBBIA LAVERDA, 3500R MIETITREBBIA LAVERDA, 3550 MIETITREBBIA LAVERDA, 3550R MIETITREBBIA LAVERDA, 355C, 3650 MIETITREBBIA LAVERDA, 3650R MIETITREBBIA LAVERDA, 3750 MIETITREBBIA LAVERDA, 3750R MIETITREBBIA LAVERDA, 455C, 465C, 465C/V/T, 505c, 555c, 565c, 605c, 765c, 805c, 80C, 855c, 90C, L517 MIETITREBBIA LAVERDA, SERIE 55 85.55.00, SERIE 65 80.65C, SERIE 65 60.65C, SERIE 65 70.65C, SERIE 66 55.66, SERIE 66 80.66, SERIE 66 80.66/F, SERIE 66 55.66, SERIE 66 60.66, SERIE 66 70.66, SERIE 66 70.66/LP-F, SERIE 66 55.66/LP, SERIE 75 70.75C, SERIE 75 80.75C, SERIE 76 70.76/LP-VF, SERIE 76 80.76/F, SERIE 85 88.85C, SERIE 85 72.85C, SERIE 85 82.85C, SERIE 88 70.88, SERIE 88 80.88, SERIE 90 115.90, SERIE 90 70.90, SERIE 90 85.90, SERIE 90 140.90, SERIE 90 55.90, SERIE 90 60.90, SERIE 90 65.90, SERIE 90 130.90, SERIE 90 80.90, SERIE 93 72.93, SERIE 93 88.93, SERIE 93 65.93, SERIE 93 82.93, SERIE 94 82.94, SERIE 94 88.94, SERIE 94 65.94, SERIE 94 72.94	1901687, 1909100, 4621740, 4651986, 4669551, 4669556, 4680444, 4787696, 70251397, 84535312, 9918114, 9924318	
02742		555C - 655C TERNA GOMMATA, 555D - 575D - 655D TERNA GOMMA	1930277	
08251		400, 411, 415	1160217, 1909108, 1909113, 1930749, 572880, 582042, 79043896	

Art./Ref.	Brand	Applicazione/Application	Rif. Orig./Orig. Ref.	Immagine/Image
15400	FIAT	160-90, 160-90 DT, 180-90, 180-90 DT	1909107, 4788504	
15401		125CA - CI, 200C, 60CA, 615 - 715, OM512 - OM513, SERIE 140 - 140CA - 140CI, SERIE 50 OM, SERIE 55, SERIE 60C - 60CI - 60CT, SERIE 70CI - 70R - 80CA - 80R	1909109, 9901486	
15402		211 - 241 - 321, 211R - 215R - 220 - 220C, 311C-312C-315C-331RS, 332C-332RS-342-351C-352C, 60CA, SERIE 18-24, SERIE 25-25R, SERIE 315 DIAMANTE, SERIE 60C - 60CI - 60CT, SERIE 70CI - 70R- 80CA - 80R	1909112, 970269	
15406		100-55 CINGOLATO, 100-90, 100-90DT, 110-90, 110-90DT, 115-90, 115-90DT, 130-90, 130-90DT, 140-90, 140-90DT, 160-90, 160-90DT, 180-90, 180-90DT, 55-56, 55-56DT, 55-66, 55-66DT, 55-66S, 55-66S DT, 55-88, 55-88DT, 55-90, 55-90DT, 60-56DT, 60-66, 60-66DT, 60-66S, 60-66S DT, 60-75 CINGOLATO, 60-75M CINGOLATO, 60-88, 60-88DT, 60-90, 60-90DT, 60-93, 60-93DT, 60-94, 60-94DT, 62-85 CINGOLATO, 62-85M CINGOLATO, 65-56, 65-56DT, 65-66, 65-66DT, 65-66S, 65-66S DT, 65-88, 65-88DT, 65-90, 65-90DT, 65-93, 65-93DT, 65-94, 65-94DT, 70-56, 70-56DT, 70-66, 70-66DT, 70-66S, 70-66S DT, 70-75 CINGOLATO, 70-75M CINGOLATO, 70-88, 70-88DT, 70-90, 70-90DT, 72-85 CINGOLATO, 72-85M CINGOLATO, 72-93, 72-93DT, 72-94, 72-94DT, 80-66, 80-66DT, 80-66DT CINGOLATO, 80-66S, 80-66S DT, 80-75 CINGOLATO, 80-88, 80-88DT, 80-90, 80-90DT, 80-93DT, 82-85M CINGOLATO, 82-93, 82-93DT, 82-94, 82-94DT, 85-90, 85-90DT, 88-85M CINGOLATO, 88-93, 88-94, 88-94DT, 90-90, 90-90DT, F100, F100DT, F110, F110DT, F115, F115DT, F120, F120DT, F130, F130DT, F140, F140DT	1930581	
02042	FORD	3010S-4010S-5010S, 3435, 3830, 3935, 4030, 4135, 4230, 4430	1930010, 87800220, 87840509	
02043		8630, 8830	1909103	
02731		2000 BSD 326, 2310 BSD 326, 2600 BSD 326, 2610>01.81 BSD 329, 2610>01.82 BSD 329, 2810 BSD 326, 2910 BSD 329, 3000 BSD 329, 3055 BSD 331, 3230 BSD 332, 3430 BSD 332, 3435 8035.06, 3600 BSD 329, 3610>01.81 BSD 332, 3610>01.82 BSD 332, 3900 BSD 332, 3910 BSD 332, 3910 H BSD 332, 3930 BSD 333, 3930 H BSD 332, 3935 8035.06, 4000 BSD 333, 4100 BSD 331, 4110>01.81 BSD 333H, 4110>01.82 BSD 333H, 4130 BSD 333, 4130 H BSD 333, 4135 8035.06, 4330 BSD 333, 4600 BSD 333H, 4610 H BSD 333, 4610>01.81 BSD 333H, 4610>01.82 BSD 333H, 4630 BSD 333H, 4635 L60 8035.05, 4830 BSD 442, 4835 L65 8045.06, 5000 4/68< BSD 442, 5000 <3/68 BSD 348, 5030 BSD 442, 5110 BSD 444, 550 BSD 333H, 555 BSD 333H, 555 A BSD 333, 555 B BSD 333, 555 C BSD 444, 5600 10/80< BSD 444, 5600<09/80 BSD 442, 5610 BSD 444, 5635 L75 8045.06, 5640 P.S. 4.4, 5700 10/80< BSD 444, 5700<09/80 BSD 442, 5900 BSD 444, 6410 BSD 444, 655 BSD 444, 655 A BSD 444, 655 C BSD 444, 655 D BSD 444, 6600 10.80> BSD 444, 6600>09.80 BSD 444, 6610 BSD 444, 6635 L85 8045.25, 6640 P.S. 5.0, 6700 BSD 444, 6710>09.80 BSD 444, 6710>10.80 BSD 444, 6810 BSD 444TS, 7000 BSD 444T, 7410 BSD 444T, 7600 BSD 444TS, 7610 BSD 444TS, 7635 L95 8045.25, 7700 BSD 444TS, 7710 BSD 444TS, 7740 P.S. 5.0T, 7810 BSD 666, 7840 P.S. 6.6, 7910 BSD 666, 8000 BSD 666, 8100 BSD 380, 8160 M100 P.S. 7.5, 8200 BSD 666, 8210 BSD 666, 8240 P.S. 7.5, 8260 M115 P.S. 7.5, 8340 9/93< P.S. 7.5T, 8340<8/93 P.S. 7.5, 8360 M135 P.S. 7.5T, 8401 BSD 666, 8530 BSD 666, 8560 M160 P.S. 7.5TI, 8600 BSD 666, 8630 BSD 666T, 8670 G170 P.S. 7.5T, 8700 BSD 666, 8730 BSD 666T, 8770 G190 P.S. 7.5T, 8830 BSD 666TI, 8870 G210 P.S. 7.5TI, 8970 G240 P.S. 7.5TI, 9000 BSD 666T, 9200 BSD 666T, 9600 BSD 666T, 9700 BSD 666T, TW 10, TW 15, TW 20, TW 25, TW 30, TW 35, TW 5	83937061, 84535312	

Art./Ref.	Brand	Applicazione/Application	Rif. Orig./Orig. Ref.	Immagine/Image
02742	FORD	3230 - 3430, 3930, 3930H - 3930N - 3930NO, 4130 - 4130N - 4130NO, 4630 - 46300 - 4630N - 4630NO, 4830 - 4830N - 48300, 5030 - 50300, 5110 - 5610, 6410 - 6610 - 6710 - 6810, 66100 - 76100, 7410 - 7610 - 7710, TW10 - TW20 - TW30	1930277, 83917626, 86570171	
15400		8630-8830	1909107	
15406		4635, 4835, 5635, 6635, 7635, 8430, 8630, 8830	1930581	
41574		5610S, 6610S, 6810S, 7010 - 8010, 7610S	87801285	
41637		8160, 8260, 8360, 8560	87840590	
41867		8160, 8260, 8360, 8560	87840591	
02042	NEW HOLLAND	1600-1620S BRAUD VENDEMMIATRICI, B115 TERNA GOMMATA, C190 PALE CARICATRICI, L190 MINI PALE, L411-L413-L416-L516 MIETITREB, L518-L520-3300AL-3560AL MIETIT, L60, L65, L75, L85, L95, LB110.B TERBA GOMMATA, LB115.B TERBA GOMMATA, LB75 TERNA GOMMATA, LB75CP TERNA GOMMATA, LB90.B TERNA GOMMATA, LB95.B TERNA GOMMATA, LM410, LM420, LM425, LM430, LM630, LM640, SB35 BRAUD VENDEMMIATRICI, SB36 BRAUD VENDEMMIATRICI, SB52 BRAUD VENDEMMIATRICI, SB54 BRAUD VENDEMMIATRICI, SB55 BRAUD VENDEMMIATRICI, SB56 BRAUD VENDEMMIATRICI, SB58 BRAUD VENDEMMIATRICI, SB62 BRAUD VENDEMMIATRICI, SB64 BRAUD VENDEMMIATRICI, TC52-TC54-TC55-TC56-TC57 MIET, TD55D, TD60, TD65D, TD70, TD75D, TD80, TD80D, TD85D, TD90, TD95, TD95D, TK100A CINGOLATO, TK65F CINGOLATO, TK65V CINGOLATO, TK70FA CINGOLATO, TK70VA CINGOLATO, TK75F CINGOLATO, TK75FA CINGOLATO, TK75M CINGOLATO, TK75MA CINGOLATO, TK75V CINGOLATO, TK75VA CINGOLATO, TK76 CINGOLATO, TK76M CINGOLATO, TK80A CINGOLATO, TK80MA CINGOLATO, TK85 CINGOLATO, TK85M CINGOLATO, TK90A CINGOLATO, TK90MA CINGOLATO, TK95M CINGOLATO, TL100, TL55F, TL60, TL60E, TL65, TL65A, TL65F, TL70, TL75, TL75E, TL75F, TL80, TL85, TL85E, TL90, TL95, TL95E, TN55, TN55D, TN55S, TN55V, TN60A, TN60DA, TN60SA, TN60VA, TN65, TN65D, TN65F, TN65N, TN65S, TN65V, TN70, TN70A, TN70D, TN70DA, TN70F, TN70NA, TN70S, TN70SA, TN70VA, TN75, TN75A, TN75D, TN75DA, TN75F, TN75FA, TN75N, TN75NA, TN75S, TN75SA, TN75V, TN75VA, TN80F, TN85FA, TN90F, TN95F, TN95FA, TN95NA, TN95VA, TT50, TT55, TT65, TT75, VL6040 VENDEMMIATRICI, VL6050 VENDEMMIATRICI, VL6060 VENDEMMIATRICI, VL6070 VENDEMMIATRICI, VL6080 VENDEMMIATRICI, VL6090 VENDEMMIATRICI, VM4090 VENDEMMIATRICI	1930010, 47135706, 84214564	

Art./Ref.	Brand	Applicazione/Application	Rif. Orig./Orig. Ref.	Immagine/Image
02043	NEW HOLLAND	MIETITREBBIE SERIE L - TX, TK 160-55 CINGOLATO	84230126	
02058		1530-1550, M103, M133/1, M135/1, M140	8123679	
02731		L454 MINI PALE, L455 MINI PALE, L553 MINI PALE, L555 MINI PALE, L778 MINI PALE, L779 MINI PALE, L781 MINI PALE, L783 MINI PALE, L785 MINI PALE, L865 MINI PALE, LX865, LX885, SB33 BRAUD VENDEMMIATRICI, SB52 BRAUD VENDEMMIATRICI, SB53 BRAUD VENDEMMIATRICI, SB54 BRAUD VENDEMMIATRICI, SB56 BRAUD VENDEMMIATRICI, SB58 BRAUD VENDEMMIATRICI, TS 100, TS 110, TS 115, TS 80, TS 90	1909100, 84535312	
08251		8070-8080	1909113	
15400		MIETITREBBIE SERIE L - TX, TK160-55 CINGOLATO, TRINCIA 9630-9640-9645, TRINCIA SERIE FX	84406504	
15406		L60, L65, L75, L85, L95, TD5.100, TD5.110, TD5.65, TD5.75, TD5.80, TD5.90, TD55D, TD60, TD60D, TD65D, TD70, TD70D, TD75D, TD80, TD80D, TD85D, TD90, TD90D, TD95, TD95D, TK100A, TK76 CINGOLATO, TK76M CINGOLATO, TK80A CINGOLATO, TK80MA CINGOLATO, TK85 CINGOLATO, TK85M CINGOLATO, TK90A CINGOLATO, TK90MA CINGOLATO, TK95M CINGOLATO, TL100, TL55F, TL60, TL60E, TL65, TL65A, TL65F, TL70, TL75, TL75E, TL75F, TL80, TL85, TL85E, TL90, TL95, TL95E, TT50, TT55, TT65, TT65D, TT75	84217953	
41574		555E - 575E - 655E TERNA GOMM, 75TLB - 85TLB - 95TLB TERNA GO, SERIE LB - LB.B TERNA GOMMATA, TC54 - TC56 MIETITREBBIA, TS100, TS110, TS115, TS120, TS80, TS90	87801285	
41637		M100, M115, M135, M160, TM110, TM115, TM120, TM125, TM130, TM135, TM140, TM150, TM155, TM165, TM175, TM180, TM190, TV140	87840590	
41867		M100, M115, M135, M160, TM110, TM120, TM130, TM140	87840591	

**FILTRI NAFTA ORIGINALI**

FILTRE A GAZOLE ORIGINAL  
 FUEL FILTER ORIGINAL  
 KRAFTSTOFF FILTER ORIGINAL  
 FILTRO GASOIL ORIGINAL

Art./Ref.	Brand	Rif. Orig./Orig. Ref.
NH1909103	NEW HOLLAND	1909103, 84230126
NH1909107		1909107, 84406504
NH1909109		1909109
NH1909113		1909113
NH1930277		1930277, 47377748
NH1930581		1930581, 84217953
NH47135706		47135706, 84214564
NH84535312		1909100, 84535312
NH84171722		84171722, 84565884
NH87487344		47367180, 84477495
NH87802332		84559020, 87802332
NH87840590		84559023, 87840590
NH87840591		84477351, 87840591

**FILTRI NAFTA ADATTABILI**

FILTRE A GAZOLE ADAPTABLE  
 FUEL FILTERS ADAPTABLE  
 KRAFTSTOFF FILTER PASSEND ZU  
 FILTRO GASOIL ADAPTABLE

Art./Ref.	Brand	Applicazione/Application	Rif. Orig./Orig. Ref.	Immagine/Image
02042	DEUTZ	Agrostar DX4.61, DX4.71, D10006, D13006, D9006, DX110, DX120, DX140, DX145, DX160, DX230, DX250, DX3.10 bis, DX3.90, DX4.10 bis, DX4.70, DX6.10, DX6.30, DX6.50, DX7.10, DX8.30, DX80, DX85, DX86, DX90, DX92, Intrac 2005, Intrac 2006, Intrac 630 Turbo	01174482	
02058		DIAMOND, EXPLORER, EXPLORER COM 3, EXPLORER T-TB COM 3, IRON, IRON COM 3, IRON CONTINUO, IRON HI-LINE, IRON HI-LINE COM 3, SILVER	01180597	
26518		D2506, D3006, D3607, D3607 A, DX.36 V	01161341, 01174696, Q05H4117	
02042	SAME	ARGON 50, ARGON 60, ARGON 70, DORADO 60, DORADO 65, DORADO 70, GOLDEN 60, GOLDEN 65, GOLDEN 75, GOLDEN 85, RUBIN 120, RUBIN 135, RUBIN 150, SILVER 100.4, SILVER 100.6, SILVER 110, SILVER 130, SILVER 80, SILVER 90	0.009.4687.0	

Art./Ref.	Brand	Applicazione/Application	Rif. Orig./Orig. Ref.	Immagine/Image
02731	SAME	ANTARES 100, ASTER 60, ASTER 70, AURORA 45, BUFFALO 120, CENTAURO 70 EXPLORER, CENTAURO 70 SPECIAL, CENTURION 75, CENTURION 75 EXPLORER, CENTURION 75 SPECIAL, CONDOR 55, CONDOR C, CORSARO 70 FRUTTETO, CORSARO 70 SYNCRO, DELFINO 35, DELFINO 35 FRUTTETO, DRAGO 100, EXPLORER 70 C, EXPLORER 55, EXPLORER 60, EXPLORER 60 SPECIAL, EXPLORER 65, EXPLORER 65 C, EXPLORER 65 SPECIAL, EXPLORER 70, EXPLORER 70 SPECIAL, EXPLORER 75, EXPLORER 75 C, EXPLORER 75 SPECIAL, EXPLORER 80, EXPLORER 80 C, EXPLORER 90 C, EXPLORER 90 II SPECIAL, EXPLORER 90 SPECIAL, EXPLORER II 60, EXPLORER II 60 SPECIAL, EXPLORER II 70, EXPLORER II 70 SPECIAL, EXPLORER II 70 SPECIAL B, FRUTTETO 60, FRUTTETO 60 II, FRUTTETO 75, FRUTTETO 75 II, FRUTTETO 85 II, LEOPARD 85, LEOPARD 85 EXPLORER, LEOPARD C, MERCURY 85 EXPLORER, MERCURY 85 SPECIAL, MINITAURO 60, MINITAURO 60 FRUTTETO, MINITAURO C, MINITAURUS 60 FRUTTETO, MINITAURUS 60 SYNCRO, PANTHER 95, RANGER 45, RANGER 45 FRUTTETO, ROW CROP 80, ROW CROP 85, ROW CROP 90, SAME ROCK 55, SAME ROCK 60, SAME ROCK 70, SATURNO 80, SATURNO 80 SYNCRO, SOLAR 50, SOLAR 55 C, SOLAR 60, SOLAR 60 C	2.4319.060.1	
02742		ANTARES 110 - 110 II, ANTARES 130 - 130 II, BUFFALO 3000, DRAGO 100 - 120, GALAXI 170, JAGUAR 95 - 100 EXPORT, LASER 100, LASER 110, LASER 125, LASER 130, LASER 150, LASER 90, LEOPARD 90 TURBO, PANTHER 90 - 95, SUPERTITAN, TIGER 100, TIGER SIX 105 EXPORT, TITAN 145, TITAN 150, TITAN 160, TITAN 165, TITAN 190, TRIDENT 130 EXPORT	2.4319.130.1	
02058		D100, D115, D115T, D150, D180, D210, D310, D310T, D500, D95, DIAMOND, R704 - R704DT, R804 - R804DT, R904 - R904DT, T5200, T6200, T6700	2.4319.500.1	
08251	SAME LAMBORGHINI HURLIMANN	1R-1C-2R-4R-5C LAMBORGHINI, 452 LAMBORGHINI, 4C-7R-7RDT LAMBORGHINI, CENTAURO 60-65 SAME, LEONE 70-75 SAME, MINITAURO 55 SAME, R226-C226 LAMBORGHINI, R230-C230-C230S LAMBORGHINI, R340-C340-C350 LAMBORGHINI, R360-R365-R470 LAMBORGHINI, R475-R480-R485 LAMBORGHINI	0.003.1413.0, 2.4319.530.4	
26518		C503S-R503S-R503DT LAMBORGHINI, R240 LAMBORGHINI, R350 LAMBORGHINI, R603-R603DT LAMBORGHINI	2.4319.510.1	

**FILTRI NAFTA ORIGINALI**

- FILTRE A GAZOLE ORIGINAL
- FUEL FILTER ORIGINAL
- KRAFTSTOFF FILTER ORIGINAL
- FILTRO GASOIL ORIGINAL



Art./Ref.	Brand	Rif. Orig./Orig. Ref.
V01180597	DEUTZ	01180597
V0.009.4687.0	SAME	0.009.4687.0
V2.4319.060.1		2.4319.060.1
V2.4319.130.1		2.4319.130.1

**FILTRI NAFTA ADATTABILI**

FILTRE A GAZOLE ADAPTABLE

FUEL FILTERS ADAPTABLE

KRAFTSTOFF FILTER PASSEND ZU

FILTRO GASOIL ADAPTABLE

Art./Ref.	Brand	Applicazione/Application	Rif. Orig./Orig. Ref.	Immagine/Image
02731	JOHN DEERE	1020, 1030, 1120, 1130, 1630, 2020, 2030, 3020, 3130, 4020, 820, 830, 920, 930	AT17387	
53230		1020, 1030, 1040, 1120, 1130, 1140, 1350, 1550, 1630, 1640, 1750, 1840, 1850, 1850N, 1950, 1950N, 2020, 2030, 2040, 2040s, 2140, 2250, 2450, 2550, 2650, 2650N, 2850, 3020, 3030, 3040, 3050, 3140, 3350, 3640, 3640S, 3650, 4030, 4040, 4040S, 4050 6359, 4240, 4240S, 4440, 5000, 5010, 5015, 5020, 6000, 6010, 6020, 6100, 820, 830, 840, 920, 930, 940	AR50041	
53237		3100, 3200, 3300, 3400, 6000, 6200, 6210, 6300, 6400, 6600, 6610, 6800, 6810, 6900, 6910	RE62418	
57934		SERIE 6000, SERIE 6010	RE62419	
85515		MOT COMMON RAIL SERIE 6010, MOT COMMON RAIL SERIE 6020, MOT COMMON RAIL SERIE SE6010, MOT COMMON RAIL SERIE SE6020	RE509208	
85516		MOT COMMON RAIL 4CIL SE6020, MOT COMMON RAIL 4CIL SERIE6015, MOT COMMON RAIL 4CIL SERIE6020	RE509031	
85517		MOT COMMON RAIL 6CIL SERIE6020, MOT COMMON RAIL 6CIL SERIE7020	RE509032	
85518		MOT COMMON RAIL 6CIL SERIE6020, MOT COMMON RAIL 6CIL SERIE7020	RE509036	
85519		GOLDONI MOTORI JOHN DEERE, SERIE 5015, SERIE 5015F&V	RE60021	



**FILTRI NAFTA ORIGINALI**

FILTRE A GAZOLE ORIGINAL  
 FUEL FILTER ORIGINAL  
 KRAFTSTOFF FILTER ORIGINAL  
 FILTRO GASOIL ORIGINAL

Art./Ref.	Brand	Rif. Orig./Orig. Ref.
JDAR50041	JOHN DEERE	AR50041
JDAR86745		AR86745
JDRE508633		RE508633
JDRE509031		RE509031
JDRE509032		RE509032
JDRE509036		RE509036, RE517180
JDRE509208		RE509208, RE517181
JDRE522878		RE522878
JDRE526557		RE526557
JDRE529643		RE529643, RE541922
JDRE529644		RE529644, RE546336
JDRE60021		RE60021
JDRE62418		RE62418
JDRE62419		RE53400, RE62419



**FILTRI NAFTA ADATTABILI**

FILTRE A GAZOLE ADAPTABLE  
 FUEL FILTERS ADAPTABLE  
 KRAFTSTOFF FILTER PASSEND ZU  
 FILTRO GASOIL ADAPTABLE

Art./Ref.	Brand	Applicazione/ Application	Rif. Orig./ Orig. Ref.	Immagine/ Image
02042		GHIBLI, GLOBUS, POWERFARM, TIER 2	E3541384M1	
02731	LANDINI	ADVANTAGE CABINATO: 55F, ADVANTAGE CABINATO: 55GT, ADVANTAGE CABINATO: 55L, ADVANTAGE CABINATO: 60F, ADVANTAGE CABINATO: 60GT, ADVANTAGE CABINATO: 60L, ADVANTAGE CABINATO: 65F, ADVANTAGE CABINATO: 65GT, ADVANTAGE CABINATO: 65L, ADVANTAGE CABINATO: 75F, ADVANTAGE CABINATO: 75GT, ADVANTAGE CABINATO: 75L, ADVANTAGE CABINATO: 85F, ADVANTAGE CABINATO: 85GT, ADVANTAGE CABINATO: 85L, ADVANTAGE CABINATO: L95GT, ADVANTAGE F.S: 55FP/LP/GT, ADVANTAGE F.S: 60FP/LP/GT, ADVANTAGE F.S: 65FP/LP/GT, ADVANTAGE F.S: 75FP/LP/GT, ADVANTAGE F.S: 85FP/LP/GT, ATLAS: 100, ATLAS: 70, ATLAS: 75, ATLAS: 80, ATLAS: 85, ATLAS: 90, BLIZZARD: 50, BLIZZARD: 60, BLIZZARD: 65, BLIZZARD: 75, BLIZZARD: 85, BLIZZARD: 95, CINGOLATI C:C4500, CINGOLATI C:C4830, CINGOLATI C:C5500, CINGOLATI C:C5830, CINGOLATI C:C6500, CINGOLATI C:C6830, CINGOLATI C:C7800, CINGOLATI C:C7830, CINGOLATI C:C8860, CINGOLATI C:C5000, CINGOLATI C:C6000, CINGOLATI C:CF4830, CINGOLATI C:CF5030, CINGOLATI C:CF5830, CINGOLATI C:CF6030, CINGOLATI C:CF6060, CINGOLATI C:CF6830, FRUTTETI 530 F/L/V: 4530V, FRUTTETI 530 F/L/V: 5530 F/L/V, FRUTTETI 530 F/L/V: 6030 F/L/V, FRUTTETI 530 F/L/V: 6530 F/L/V, FRUTTETI 530 F/L/V: 7530 F/L/V, FRUTTETI 560 F/L/V: 4560V, FRUTTETI 560 F/L/V: 5560 F/L/V, FRUTTETI 560 F/L/V: 6060 F/L/V, FRUTTETI 560 F/L/V: 6560 F/L/V, FRUTTETI 560 F/L/V: 7560 F/L/V, FRUTTETI 560 F/L/V: 8560 F/L/V, GHIBLI: 100, GHIBLI: 90, GHIBLI:80, GLOBUS: 55, GLOBUS: 60, GLOBUS: 65, GLOBUS: 70, LARGE: 10000, LARGE: 10000S, LARGE: 12500, LARGE: 13000, LARGE: 14500, LEGEND N/G: 115, LEGEND N/G: 120, LEGEND N/G: 130, LEGEND N/G: 140, LEGEND N/G: 160, LEGEND N/G: 180, LEGEND: 105, LEGEND: 115, LEGEND: 130, LEGEND: 145, LEGEND: 165, MYTHOS: 110, PRIMI MODELLI 5000R-DT-S-N, PRIMI MODELLI 6000R-DT-S, PRIMI MODELLI 7000 SPECIAL, PRIMI MODELLI 7000R-DT, PRIMI MODELLI 8000R-DT-S, REX CABINATI: 100, REX CABINATI: 60, REX CABINATI: 70, REX CABINATI: 80, REX CABINATI: 90, REX FOOT STEP: 100FP-LP-GTP-GE, REX FOOT STEP: 60FP-LP-GE, REX FOOT STEP: 70FP-LP-GTP-GE, REX FOOT STEP: 80FP-LP-GTP-GE, REX FOOT STEP: 90FP-LP-GTP-GE, SERIE 30: 5830, SERIE 30: 6030, SERIE 30: 6830, SERIE 30: 7830, SERIE 30: 8830, SERIE 40: 5840, SERIE 40: 6040, SERIE 40: 6840, SERIE 500: 5500, SERIE 500: 6500, SERIE 500: 7500, SERIE 500: 8500, SERIE 500: 9500R-DT, SERIE 50: 6550, SERIE 50: 7550, SERIE 50: 8550, SERIE 60 NEW: 5860, SERIE 60 NEW: 6860, SERIE 60 NEW: 7860, SERIE 60 NEW: 8860, SERIE 60: 5860, SERIE 60: 6060, SERIE 60: 6860, SERIE 60: 7860-7860HC, SERIE 60: 8860-8860HC, SERIE 60: 9060, SERIE 70: 5870, SERIE 70: 6070, SERIE 70: 6870, SERIE 70: 7870, SERIE 70: 8870, SERIE 80: 6880, SERIE 80: 7880, SERIE 80: 8880-8880HC, SERIE 80: 9080-9080HC, SERIE 80: 9880-9880HC, TREKKER NEW 100C, TREKKER NEW 70 C/F/L, TREKKER NEW 80 C/F/L, TREKKER NEW 90 C/F/L, TREKKER: C75, TREKKER: C85, TREKKER: C95, TREKKER: CF55, TREKKER: CF60, TREKKER: CF65, TREKKER: CF70, TREKKER: CF75, TREKKER: CF85, VIGNETI CABINA V.Q: 55V, VIGNETI CABINA V.Q: 60V, VIGNETI CABINA V.Q: 65V, VIGNETI CABINA V.Q: 75V, VIGNETI F.S: 55V, VIGNETI F.S: 60V, VIGNETI F.S: 65V, VIGNETI FOOT STEP: 75V, VIGNETI REX CAB: 60V, VIGNETI REX CAB: 65V, VIGNETI REX CAB: 70V, VIGNETI REX CAB: 80V, VISION: 100, VISION: 80, VISION: 90	E3541160M1	
02742		CINGOLATI: C10500, LARGE: 16000, LARGE: 16500	1896287M91, E3541382M1	
37104		MISTRAL:40, MISTRAL:45, MISTRAL:50	3653390M1	

**FILTRI NAFTA ORIGINALI**

FILTRE A GAZOLE ORIGINAL  
 FUEL FILTER ORIGINAL  
 KRAFTSTOFF FILTER ORIGINAL  
 FILTRO GASOIL ORIGINAL

Art./Ref.	Brand	Rif. Orig./Orig. Ref.
LN3653390M1	LANDINI	3653390M1
LNE3541384M1		E3541384M1
LNE3541382M1		E3541382M1
LNE3541160M1		E3541160M1

**FILTRI NAFTA ADATTABILI**

FILTRE A GAZOLE ADAPTABLE  
 FUEL FILTERS ADAPTABLE  
 KRAFTSTOFF FILTER PASSEND ZU  
 FILTRO GASOIL ADAPTABLE

Art./Ref.	Brand	Applicazione/Application	Rif. Orig./Orig. Ref.	Immagine/Image
02042	MASSEY FERGUSON	3075 1004.4, 3075 A4.236, 3085 1006.6, 3095 1006.6, 3115 1006.6, 3120 1006.6T, 3120T 1006.6T, 3125 1006.6T, 3140 1006.6T, 3635 1006.6T, 3645 1006.6T, 3655 1006.6T, 3660 1006.6T, 4225 1004.4, 4225 4.41, 4235 1004.4, 4235 4.41, 4245 1004.4T, 4255 1004.4T, 4255 4.41, 4260 1006.6, 4270 1006.6, 6110 4.41, 6120 4.41, 6130 1004.4T, 6140 1004.4T, 6150 1004.4T, 6160 1006.6, 6160 1006.6T, 6170 1006.6, 6170 1006.6T, 6180 1006.6T, 6190 1006.6T, 8110 1006.6T, 8120 1006.6T <F, 8130 1006.6T	2862362M1, 3638281M1, 3638291M1, 3638510M1	
02731		1080 A4.318, 1100 A6.354.1, 1105 A6.354.4, 1135 A6.354.4, 1200 A6.354.1, 1250 A6.354.4, 135 AD3.152, 148 AD3.152, 155 AD4.203, 158 AD4.203, 165 A4.212, 165 AD4.203, 168 A4.236, 175 A4.236, 178 A4.248, 185 A4.248, 230 AD3.152, 235 AD3.152, 240 AD3.152, 250 AD3.152, 255 AD3.152, 260 AD4.203, 2620 A6.354.4, 2625 A6.354.4, 2640 A6.354.4, 2645 A6.354.4, 265 A4.236, 2680 AT6.354.4, 2685 AT6.354.4, 2720 AT6.354.4, 2725 AT6.354.4, 275 A4.236, 285 A4.248, 285 A4.318, 290 A4.248, 294 A4.248, 296, 298 A4.318, 3050 A4.236, 3060 A4.248, 3065 A4.236, 3070 A4.236, 3075 1004.4, 3075 A4.236, 3080 A6.354.4, 3085 1006.6, 3090 A6.354.4, 3095 1006.6, 3115 1006.6, 3120 1006.6T, 3120T 1006.6T, 3125 1006.6T, 3140 1006.6T, 340 AD3.152, 342 AD3.152, 35 A3.152, 350 AD3.152, 352 AT3.152, 355 AT3.152, 360 AT3.152, 3610 A6.354.4, 362 A4.236, 3630 AT6.534.4, 3635 1006.6T, 3645 1006.6T, 3645 AT6.354.4, 365 A4.236, 3650 AT6.354.4, 3655 1006.6T, 3660 1006.6T, 372 A4.236, 375 A4.236, 382 A4.248, 390 A4.248, 390T A4.236, 398 A4.236, 399 1006.6, 399 A6.354.4, 4225 1004.4, 4225 4.41, 4235 1004.4, 4235 4.41, 4245 1004.4T, 4255 1004.4T, 4255 4.41, 4260 1006.6, 4270 1006.6, 550 AD3.152, 560 AD4.203, 565 A4.236, 575 A4.236, 590 A4.248, 595 A4.318, 6110 4.41, 6120 4.41, 6130 1004.4T, 6140 1004.4T, 6150 1004.4T, 6160 1006.6, 6160 1006.6T, 6170 1006.6, 6170 1006.6T, 6180 1006.6T, 6190 1006.6T, 65 A4.203, 65 AD4.203, 675 A4.236, 690 A4.248, 698 A4.318, 698T A4.236, 699 A6.354.4, 765 AD4.203, 8110 1006.6T, 8120 1006.6T <F, 8120 1006.6T F0, 8130 1006.6T	1049939M91, 151890M1, 1640997M91, 1802271M1, 1841890M1, 1951890M1, 2871492M1, 3405418M1, 835994M92, 836218M91, 851890M1	
02742		1080 A4.318, 1100 A6.354.1, 1105 A6.354.4, 1135 A6.354.4, 1200 A6.354.1, 1250 A6.354.4, 135 AD3.152, 148 AD3.152, 155 AD4.203, 158 AD4.203, 165 A4.212, 165 AD4.203, 168 A4.236, 175 A4.236, 178 A4.248, 185 A4.248, 230 AD3.152, 235 AD3.152, 240 AD3.152, 250 AD3.152, 255 AD3.152, 260 AD4.203, 2620 A6.354.4, 2625 A6.354.4, 2640 A6.354.4, 2645 A6.354.4, 265 A4.236, 2680 AT6.354.4, 2685 AT6.354.4, 2720 AT6.354.4, 2725 AT6.354.4, 275 A4.236, 285 A4.248, 285 A4.318, 290 A4.248, 294 A4.248, 298 A4.318, 3050 A4.236, 3060 A4.248, 3065 A4.236, 3070 A4.236, 3080 A6.354.4, 3090 A6.354.4, 340 AD3.152, 342 AD3.152, 350 AD3.152, 352 AT3.152, 355 AT3.152, 360 AT3.152, 3610 A6.354.4, 362 A4.236, 3630 AT6.534.4, 3645 AT6.354.4, 365 A4.236, 3650 AT6.354.4, 372 A4.236, 375 A4.236, 382 A4.248, 390 A4.248, 390T A4.236, 398 A4.236, 550 AD3.152, 560 AD4.203, 565 A4.236, 575 A4.236, 590 A4.248, 595 A4.318, 675 A4.236, 690 A4.248, 698 A4.318, 698T A4.236, 699 A6.354.4, 765 AD4.203, 796, 8120 1006.6T F0	1896287M1, 3405419M1	
11267			35 A3.152, 65 A4.203, 65 AD4.203, FE35 4cil 23C, TEF20 4cil 20C	1850450M2, 894974M91

**FILTRI NAFTA ADATTABILI**

FILTRE A GAZOLE ADAPTABLE  
 FUEL FILTERS ADAPTABLE  
 KRAFTSTOFF FILTER PASSEND ZU  
 FILTRO GASOIL ADAPTABLE

Art./Ref.	Brand	Applicazione/Application	Rif. Orig./Orig. Ref.	Immagine/Image
02042	PERKINS	1006.60, 500 TURBO ED ASPIRATO	26561118	
02731		1004.40, 1004.40T, 1004.42, 3.152.2, 3.152.4, 4.108, 4.236, 403D-11, 403D-15, 404D-22, 6.354.4, D3.152, T4.236, T6.354.4	26560017, 26561117	
02742		6.354 - T6.354, 6.354.4 - T6.354.4, V8.540 - TV8.540	26560602, 26566602	
70564		1103A-33, 1103A-33T, 1103C-33, 1103C-33T, 1103C-33TA	26560163	
70565		1104A-44, 1104A-44T, 1104A-44TA, 1104C-44, 1104C-44T, 1104C-44TA, 1104CE-44TA, 1104D-44, 1104D-44T, 1104D-44TA	26560201	

**FILTRI NAFTA ORIGINALI**

FILTRE A GAZOLE ORIGINAL  
 FUEL FILTER ORIGINAL  
 KRAFTSTOFF FILTER ORIGINAL  
 FILTRO GASOIL ORIGINAL



Art./Ref.	Brand	Rif. Orig./Orig. Ref.
PK26560201	PERKINS	26560201
PK26561117		26561117
PK26561118		26560608, 26561118
PK26566602		26566602

**FILTRI NAFTA ADATTABILI ALTRI MARCHI**

FILTRE A GAZOLE ADAPTABLE AUTRES MARQUES

FUEL FILTERS ADAPTABLE OTHER BRANDS

KRAFTSTOFF FILTER PASSEND ZU ANDERE MARKEN

FILTRO GASOIL ADAPTABLE OTRAS MARCAS

Art./Ref.	Brand	Applicazione/Application	Rif. Orig./Orig. Ref.	Immagine/Image
02042		10S, 11S, 12S, 303 bis, 307LSA, 307, 308, 308LSA FWA 178/26, 309, 309LSA, 310, 310LSA, 311, 311LSA, 312, 312LSA, 345GT, 360GT, 360GTH, 365GTA, 380GHA, 380GT, 380GTA, 600LSA, 610LSA, 611LSA, 612LSA, 614LSA, 615LSA, 822 Turbo, 824 Turbo	F180201060030	
02731	FENDT	108LSA, 108S, 200S, 201S, 203V, 204P, 205P, 240S, 250SA, 250VA, 275VA, 280PA	F278201060040	
08251		1 FL237, 2 FW139/3, 230GT, 2E 139/1,3, 2S FW138/11, 2S FWA138/7, 3S FW238/1, 3S FWA238/7, 4S FWA 258, 811SL	F015200060180	
26518		200V-200K-203V-203K-204V-204P, 205P-203P-203PII-203VII, 240-250V-250VA-260P-260PA, 260V-260VA-270P-270PA, 270V-270VA-280P-280PA, FARMER 102-102S-102SA, FARMER 103-103S-103LS-103LSA, FARMER 104S-104LS-104LSA-104SA, FARMER 105-105SA, FARMER 105S-105LS, FARMER 106S TURBO MATIC, FARMER 108S-108LS, FARMER 200-200SA-201S-201SA, FARMER 240S-250S-260S-275S, FARMER 25 EXPORT, FARMER 3S, FAVORIT 3	F138204060020, F138204060080	
02042		LDW 1003, LDW 1204, LDW 1404, LDW 903	2175.143	
02058	LOMBARDINI	5LD 2-3 cil 3/T, 11LD, 5LD 4 cil, 8LD, 9LD, CHD 1503, CHD 2004, CHD 2004/T, DVA 1030, DVA 1030/S, DVA 1200, LDW 1204, LDW 1404	2175.046	
02731		673, 825, LDA 670, SLD675	2175.042	
08251		5LD 625-3 TURBO, 5LD 675-2, 5LD 675-3, 5LD 675-4, 5LD 825-2, 5LD 825-2L, 5LD 825-3, 5LD 825-3L, 5LD 825-4, 5LD 825-4L, 5LD 930-3, 5LD 930-4, LDA 672, LDA 673, LDA 674, LDA 832, LDA 833, LDA 834	2175.014	
26518		400 - 6LD400C - 400V, 6LD260 - 260C, 6LD325 - 325C, 6LD360 - 360C, 6LD360V, 6LD435, LDA500 - 503 - 520 - 522 - 530	2175.045	
02058		RENAULT	155-54TA/TE/TX/TZ, 160-94TZ, 180-94TZ, 175-74TZ, 321-4, 451-4, 571-4, 481-4, 581-4, 50-12LB/V, 55-12LB/V, 70-12V/F, R1451-4	6005000383, 6005000788, 7701017732

Art./Ref.	Brand	Applicazione/Application	Rif. Orig./Orig. Ref.	Immagine/Image
02731	RENAULT	103.12RS/TX, 103.14RS/TX, 103.54TM/TX, 106-14SP, 110-14RE/TA/TE/TS/TX, 106.14RS/TX, 106.54TL, 110.54T, 106.54 MWM, 110-54TA/TE/TS/TX/TZ, 120-54TA, 113.14TX, 133.14TS/TX, 145.14T, 1151 1151-4, 1181 1181-4, 1451-4 (R7694), 155.54TZ, 155.54TX/TZ/Nectra,, 301, 351M, 32-5032-60, 321-4, 451-4, 571-4, 42-70F/V, 44-70F/V, 421 M, 421M, 456 M, 460 M, 461, 461M/Spezial, 462 M, 466S, 480S/V, 486 M, 489 M, 490 (R7398-4-L), 496 M, 498 M, 50 (7211) MWN 325-2, 50 S/SV MWN D327-2, 50.12LB, 55.12LB, 58.32MX, 58., 501-4, 601-4, 51 (7256) 56 (7251), 53 (7213) MWN 325-2, 55 (7231) 57 (7241), 551 551-4, 551-43, 556 556S, 58-12LS, 58-14LS, 61-12RA/RS,, 58-32MA/ME/MS/MX, 58-34MA/ME/M, 60 (7253) 61 (7254), 600M, 600MI, 60S MWN 325-3, 61.12RS, 61.14S/RS MWN 325-3, 65.12LS, 65.32MX, 65.34MX D22, 651, 651-4, 652, 656, 656S, 68, 68-12RA/RS, 68-14RA/RS, 75-12L, 68.12RS 68.14RS, 70 MWM D305-3R, 70 (7252) MWM, 70-12SP, 70-14SP, 70-32PA/PE/PS/PX, 70-34PA/PE/P, 70.12LB, 70.14LB, 70.34PX/Trac, 700M/H, 720M/H, 704M/H, 724M/H, 701-4, 701-4F, 75-32MA/ME/MS/MX/TX, 75-34ME/M, 750MI, 745MI, 800M, 804M, 850M, 751, 751S, 751-4, 752, 781, 78, 80 MWM D305-3R, 80 MWM D325-3R, 80 (7282) 86 (7281), 80-12, 80-14, 85.34MX, 85.34TX, 80-12SP, 80-14SP, 80-12TX, 80-14TX, 80-32PA/PE/PS/PX, 80-34PA/PE/P, 80S/V MWM D327, 85-12LS/TS/TX, 85-14LS/TS/TX, 85-32MA/ME/MS/MX/TX, 85-34MA/M, 85.12LS 85.14LS, 851, 851-4, 851-4S, 86, 88 598-, 89 MWM D226-3, 891, 891-4, 90.34MX/Tractor, 90.34TX91TP91, 900MIH, 904MIH, 90S/V/Conf., 92, 921 921-4, 95-12RE/RS/TS/TX, 95-14RE/RS/T, 95.12TX 95.14TX, 981 981-4, Ceres65, Ceres70, Ceres70X, Ce, Ceres85, Ceres85X, Ceres95, Ce, Master 1, Master 1 TP, Master, MWM D325-4R, 226-4, 325-4, D22, R301, R351M, R32-50EV-SV-V, R32-60F-V(A/B), R361, R421-421M, R461, R461M,, R42-70V, R44-70F, R90S Verger,, R50, R51, R56, R60, R70, R80,, R50S, R53, R55, R551, R551S, R551-4, R551-4S,, R651, R651S, R651-4, R651-4S,, R751, R751S, R751-4, R751-4S,, R782, R782-4, R851, R851-4, R8, R89, R92, R489, R891, R891S, R891-4S, R951, R9, R91, R94, R96, R98, R496, R498, Super 5D, Super 7, Super 7D	6005000894, 6005007409	
02742		110-54TA/TE/TS/TX/TZ, 120-54TA, 133-12TS/TX, 133-14RE/TA/TS/TX, 58-12LS, 58-14LS, 61-12RA/RS,, 58-32MA/ME/MS/MX, 58-34MA/ME/M, 650MI	6005000895, 6005007410	
08251		Super 6, Super 6D	0854806000	
02058	RUGGERINI	11 LD 625, L27, L40, L54, LDA672, LDA673, LDA674, LDA832	175.19	
02731		833	-	
02042		9084 WD401, M975 WD301, 1108 WD61.44, 1200 WD612.40, 1300 WD61.44, 1350 WD61.44, 540, 545, 548, 650, 7070, 760, 768, 8055A, 8055S, 8060, 8065 Turbo, 8070A, 8075, 8080 Turbo, 8090, 8100, 8110, 8120, 8130, 8130 Turbo, 8140, 8150, 8160 WD612.85, 612.89, 8160A WD612.85, 612, 8170 Turbo, 8170A WD612.85, 612, 870, 9078A WD401, 9083A WD401, 9086 WD401, 9086A WD401, 9094A WD401, 9105A, 9115A, 9125A, 9145A, 942 WD308.48, 308., 946A WD301, 948 WD308.48, 308., 955A WD301, 970A WD301, 980, 988, M968A WD301, Plus 30, 430 WD210, Plus 80, 90 1	407080074, 407080116	
02742	STEYR	M9078A, Valmet 420.81, 420., M9086 Valmet 420.81, 420.82., M9094 Valmet 420.81, 420.	P945X	
08251		180 2A, 180A, 182A, 185, 188, 190, 190S, 192, 288, 290, 292, 8160 Turbo WD612.85, 8170 Turbo, 8180 Turbo WD612.89, 8300, 84E, 88, 92, Plus 40 WD307/W410, Plus 50 WD307/W410, Plus 70 WD307/W410, Plus 80, 90 1 A Serie	407 08 01 32	

**TABELLA COMPARAZIONI FILTRI NAFTA PER CODICE AMA - ARTICOLI ADATTABILI ALLE SEGUENTI MARCHE**

TABLEAU COMPARAISONS DIESEL FILTRES POUR CODE AMA

TABLE OF DIESEL FILTER COMPARISONS PER AMA CODE

KRAFTSTOFF FILTER VERGLEICHSTABELLE NACH AMA-CODE

TABLA COMPARACIONES FILTROS GASOIL PARA CODIGO AMA

Riferimento AMA	OEM	Riferimento FIAAM	Riferimento Tecnicar	Riferimento M+H	Riferimento Donaldson	Riferimento UFI	Note
02042	1930010	FP4935A	RN58B	WK842/1	P55-0588	24.355.00	ALLIS (1903628, applicaz.8065LE00), CAV (7176-496A), FLEETGUARD (FF5135)
02043	1909103	FT4713	RN170	WK1168	P55-1605	24.308.00	-
02058	2175.046	FP4683	RN45	WK731	P55-0440, P55-0943, P55-3004, P77-9451	24.307.00	CAV (7176-494), GOLDONI
02731	1909100	FP4378	N1117	P917x	P55-6245	24.360.00	CAV (7111-296), KUBOTA (15451-43560), LINDNER (P917X)
02742	1930277	FP4779	N1118	P945x	P55-6287	24.361.00	CAV (7111-796)
08251	1909108	FA4487	N1147	P707	-	26.609.00	BOSCH (1.457.431.261)
11267	1850450M2	FA4167	N11816	P824X	-	26.602.00	BALDWIN (PF820S)
15400	1909107	FD1513	N1134	P982X	P55-0347	21.059.00	-
15401	1909109	FA4156	N11950	P947	P77-9318	26.605.00	-
15402	1909112	FA4154	N1124	P825T	P77-9257	26.606.00	-
15406	1930581	FT5331	RN120	WK9029	-	-	-
26518	2.4319.510.1	FP4712	RN297	WK712/2	P55-0345	24.357.00	FRAM (P4506)
37104	3653390M1	-	-	-	P50-2161	26.681.00	BALDWIN (PF717)
41574	87801285	FT5550	RN144	WK8123	P55-1433	24.432.00	-
41637	87840590	-	-	WK8114	P55-0435	-	BALDWIN (BF7677D)
41867	87840591	-	-	-	P55-1430	-	BALDWIN (BF7679D)
53230	AR50041	FT4903	-	WK13001	P55-1130	-	-
53237	RE62418	-	-	-	P55-1423	-	BALDWIN (BF7675D), FLEETGUARD (FS19831)
57934	RE62419	-	-	-	P55-0397	-	BALDWIN (BF7674)
70564	26560163	-	-	-	-	-	BALDWIN (BF7925), FIL FILTER (MFE1490)
70565	26560201	-	-	-	-	-	BALDWIN (PF7902), FIL FILTER (MFE1489)
85515	RE509208	-	-	-	-	-	-
85516	RE509031	-	-	-	-	-	-
85517	RE509032	-	-	-	-	-	-
85518	RE509036	-	-	-	-	-	-
85519	RE60021	-	-	-	-	-	-

# 1.7.2 Filtri Olio

Oil Filters



## Ricambi & accessori per macchine agricole

SPARE PARTS & ACCESSORIES FOR AGRICULTURAL MACHINE

Tutti gli articoli della presente sezione, prodotti da AMA SPA e/o da terzi per conto di AMA, sono adattabili ("non originali") alle marche indicate ai sensi di quanto previsto dal REG. CE n. 1400/2002. I diritti sui marchi citati appartengono ai legittimi proprietari e il loro uso ha l'esclusiva finalità di consentire all'utilizzatore la comparazione dei diversi prodotti. All items of this section, manufactured by AMA SPA and/or any third party on behalf of AMA, are adaptable ("non-original") to the brands listed under the provisions of the REG. CE n. 1400/2002. The rights on the trademarks belong to their respective owners and their usage is only aimed to allow the user to compare different products.

**FILTRI OLIO ADATTABILI**

FILTRE A HUILE ADAPTABLE

OIL FILTER ADAPTABLE

OELFILTER PASSEND ZU

FILTRO ACEITE ADAPTABLE

Art./Ref.	Brand	Applicazione/Application	Rif. Orig./Orig. Ref.	Immagine/Image
27459	CASE		1329020C2	
53208		238-248-258-268-278, 2400 - 2500, 3210-3220-3230, 3210A-3220A-3230A-4210A-4220, 385-395, 454-474-574-674, 484-584-684-784, DAL 485XL AL 785XL	3136046R93	
02039	FIAT	120C, 355C, 455C, 465C, 465C/V/F, 505c, 555c, 565c, 605c, 655C, 765C, 805C, 80C, 855C, 90C, SERIE 55 85.55C, SERIE 65 80.65C, SERIE 65 55.65C, SERIE 65 60.65C, SERIE 65 70.65C, SERIE 66 55.66/VF, SERIE 66 56.66S, SERIE 66 60.66/LP, SERIE 66 65.66, SERIE 66 80.66, SERIE 66 80.66/F, SERIE 66 55.66, SERIE 66 60.66, SERIE 66 70.66, SERIE 66 70.66/LP-F, SERIE 66 45.66, SERIE 66 55.66/LP, SERIE 66 50.66, SERIE 75 55.75C, SERIE 75 60.75C, SERIE 75 70.75C, SERIE 75 80.75C, SERIE 76 45.76/V, SERIE 76 60.76/F, SERIE 76 70.76/LP-VF, SERIE 76 80.76/F, SERIE 85 55.85C, SERIE 85 60.85C, SERIE 85 72.85C, SERIE 85 82.85C, SERIE 85 62.85C, SERIE 86 70.86/V, SERIE 86 72.86/LP-F, SERIE 86 82.86/LP-F, SERIE 86 50.86/V, SERIE 86 55.86/VF, SERIE 86 60.86/VF, SERIE 86 62.86/F, SERIE 88 55.88, SERIE 88 60.88, SERIE 88 70.88, SERIE 88 80.88, SERIE 90 70.90, SERIE 90 55.90, SERIE 90 60.90, SERIE 90 65.90, SERIE 90 80.90, SERIE 93 65.93, SERIE 93 72.93, SERIE 93 60.93, SERIE 93 82.93, SERIE 94 72.94, SERIE 94 82.94, SERIE 94 60.94, SERIE 94 65.94	1901603, 1909101, 4597232, 4600875, 4625547, 4629544, 4630786, 4648371	
02041		100-90, 100-90 DT, 110-90, 110-90 DT, 115-90, 115-90 DT, 55-86F, 55-86F DT, 55-86S V, 55-86S V DT, 55-86V, 55-86V DT, 85-90, 85-90DT, 88-93, 88-93 DT, 88-94, 88-94DT, 90-90, 90-90DT, F100, F100 DT, F110, F110 DT, F115, F115 DT, F120, F120 DT	1901602, 1909102, 4602186, 4607360, 4625546, 4630787	
08250		80.66 - 80.66DT, 80.76 - 80.76DT	1930328, 83918040, 83963907, 87800083	
10499		130-90, 130-90 DT, 140-90, 140-90 DT, 160-90 DT, 180-90 DT, F130, F130 DT, F140, F140 DT	1930213, 1931047	
15141		311 - 311C, 312 - 312C, 315, 352C	1909110, 883834	
15403		50C OM, 60CA, OM 512 - OM 513, SERIE 60C - 60CI - 60CT, SERIE 70CI - 70R, SERIE 80CA - 80R	1901599, 1909123, 4585298, 4597635, 556404, 556494	



Art./Ref.	Brand	Applicazione/Application	Rif. Orig./Orig. Ref.	Immagine/Image
15405		140-90 DT, 160-90, 160-90 DT, 180-90, 180-90 DT	1909137, 1930544, 79026104, 80437070, 80437072	
27459	FIAT	G170, G190, G210, G240	81879134	
37997		35.66 35.66DT	1930892	
02039		3010S, 3435, 3830, 3935, 4010S, 4030, 4135, 4230, 4430, 5010S	1909101	
02041		3010S, 3830, 4635, 4835, 5635, 6635, 7635	1909102	
08250		2000, 5000, 5500, 5610 - 5710, 6610 - 6610 SERIES II, 6710 - 6710 SERIES II, 7000 BSD 444T, 7600 BSD 444TS, 7610 BSD 444TS, 7700 BSD 444TS, 7710 BSD 444TS, 8210	A710X6714CA	
10499	FORD	8430-8630-8830	1931047	
11259		7810-78100-7910, 8210, 8530, 8630, 8730, 8830, TW5 - TW15 - TW25 - TW35	86546615	
15405		8430-8630-8830	1930544	
27459		5610S, 5640, 6610S, 6640, 66400, 6810S, 7010-8010, 7610S, 7740, 77400, 7810S, 8160, 8260, 8360, 8560, 8670 - 8670A, 8770 - 8770A, 8870 - 8870A, 8970 - 8970A, SERIE 675	81879134	

Art./Ref.	Brand	Applicazione/Application	Rif. Orig./Orig. Ref.	Immagine/Image
35102	FORD	2000 BSD 326, 2310 BSD 326, 2600 BSD 326, 2610>01.81 BSD 329, 2610>01.82 BSD 329, 2810 BSD 326, 2910 BSD 329, 3000 BSD 329, 3055 BSD 331, 3230 BSD 332, 3430 BSD 332, 3600 BSD 329, 3610>01.81 BSD 332, 3610>01.82 BSD 332, 3900 BSD 332, 3910 BSD 332, 3910 H BSD 332, 3930 BSD 333, 3930 H BSD 332, 4000 BSD 333, 4100 BSD 331, 4110>01.81 BSD 333H, 4110>01.82 BSD 333H, 4130 BSD 333, 4130 H BSD 333, 4600 BSD 333H, 4610 H BSD 333, 4610>01.81 BSD 333H, 4610>01.82 BSD 333H, 4630 BSD 333H, 4830 BSD 442, 5000 4/68< BSD 442, 5000 <3/68 BSD 348, 5030 BSD 442, 5110 BSD 444, 550 BSD 333H, 555 BSD 333H, 555 A BSD 333, 555 B BSD 333, 555 C BSD 444, 5600 10/80< BSD 444, 5600<09/80 BSD 442, 5610 BSD 444, 5700 10/80< BSD 444, 5700<09/80 BSD 442, 5900 BSD 444, 6410 BSD 444, 655 BSD 444, 655 A BSD 444, 655 C BSD 444, 6600 10.80> BSD 444, 6600>09.80 BSD 444, 6610 BSD 444, 6700 BSD 444, 6710>09.80 BSD 444, 6710>10.80 BSD 444, 6810 BSD 444T5, 7410 BSD 444T	83933906, 83963906, 84259320, 87800068	
02039		3300 MIETITREBBIA LAVERDA, 3300R MIETITREBBIA LAVERDA, 3400 MIETITREBBIA LAVERDA, 3400R MIETITREBBIA LAVERDA, SB52 BRAUD VENDEMMIATRICI, SB54 BRAUD VENDEMMIATRICI, TK55-65F, TK55-65M, TK55-65V, TK55-75F, TK55-75M, TK55-75V, TK55-85F, TK55-85V, TK60-65, TK60-65M, TK60-65V, TK60-75, TK60-75M, TK60-75V, TK60-85F, TK60-85V, TK62-85, TK62-85M, TK70-65, TK70-65M, TK70-75, TK70-75M, TK72-85, TK72-85M, TK80-65, TK80-75, TK82-85M, TK85-55, TL100, TL65, TL70, TL80, TL90	1909101	
02041		3300AL MIETITREBBIA LAVERDA, 3400 MIETITREBBIA LAVERDA, 3400R MIETITREBBIA LAVERDA, 3500 MIETITREBBIA LAVERDA, 3500R MIETITREBBIA LAVERDA, 3550 MIETITREBBIA LAVERDA, 3550R MIETITREBBIA LAVERDA, L60, L65, L75, L85, L95, LB75 TERNA GOMMATA, LB75C TERNA GOMMATA, LM 410 SOLLEVATORE TELESOPICI, LM 420 SOLLEVATORE TELESOPICI, LM 425 SOLLEVATORE TELESOPICI, LM 430 SOLLEVATORE TELESOPICI, LM 630 SOLLEVATORE TELESOPICI, LM 640 SOLLEVATORE TELESOPICI, SB33 BRAUD VENDEMMIATRICI, SB35 BRAUD VENDEMMIATRICI, SB53 BRAUD VENDEMMIATRICI, SB55 BRAUD VENDEMMIATRICI, SB56 BRAUD VENDEMMIATRICI, SB58 BRAUD VENDEMMIATRICI, SB60 BRAUD VENDEMMIATRICI, SB62 BRAUD VENDEMMIATRICI, SB64 BRAUD VENDEMMIATRICI, TD55D, TD65D, TD75D, TD85D, TK100-55 CINGOLATO, TK88-85M CINGOLATO, TK95-55 CINGOLATO, TL100, TL55F, TL60, TL60E, TL65, TL65A, TL65F, TL70, TL75, TL75E, TL75F, TL80, TL85, TL85E, TL95, TL95E	84221215	
10499		3500 MIETITREBBIA LAVERDA, 3500R MIETITREBBIA LAVERDA, 3550 MIETITREBBIA LAVERDA, 3550AL MIETITREBBIA LAVERDA, 3550R MIETITREBBIA LAVERDA, 3560AL MIETITREBBIA LAVERDA, 3650 MIETITREBBIA LAVERDA, 3650R MIETITREBBIA LAVERDA, 3750 MIETITREBBIA LAVERDA, 3750R MIETITREBBIA LAVERDA, L517-L518-L520 MIETIT. LAVERDA, SB33 BRAUD VENDEMMIATRICI, SB35 BRAUD VENDEMMIATRICI, SB36 BRAUD VENDEMMIATRICI, SB52 BRAUD VENDEMMIATRICI, SB53 BRAUD VENDEMMIATRICI, SB54 BRAUD VENDEMMIATRICI, SB55 BRAUD VENDEMMIATRICI, SB56 BRAUD VENDEMMIATRICI, SB58 BRAUD VENDEMMIATRICI, SB60 BRAUD VENDEMMIATRICI, SB62 BRAUD VENDEMMIATRICI, SB64 BRAUD VENDEMMIATRICI	1931047	
15403	NEW HOLLAND		84588864	
15405		MX240-MX240R MIETIT. LAVERDA, TK160-55	1930544	
27459		AL519 MIETITREBBIA LAVERDA, AL59 MIETITREBBIA, L411 MIETITREBBIA LAVERDA, L413 MIETITREBBIA LAVERDA, L416 MIETITREBBIA LAVERDA, L516 MIETITREBBIA LAVERDA, LX985 MINI PALE, M100, M115, M135, M160, TC52 MIETITREBBIA, TC54 MIETITREBBIA, TC56 MIETITREBBIA, TF76 MIETITREBBIA, TM110, TM115, TM120, TM125, TM130, TM135, TM140, TM150, TM155, TM165, TM175, TM180, TM190, TR87 MIETITREBBIA ROTATIVA, TR88 MIETITREBBIA ROTATIVA, TR97 MIETITREBBIA ROTATIVA, TS100, TS110, TS115, TS120, TS80, TS90, TV140, TX34 MIETITREBBIA, TX62 MIETITREBBIA, TX63 MIETITREBBIA, TX64 MIETITREBBIA, TX65 MIETITREBBIA, TX66 MIETITREBBIA, TX67 MIETITREBBIA, TX68 MIETITREBBIA	81879134	
35102		345D TERNA GOMMATA, 420 TERNA GOMMATA, 445C - 555C - 655C TERNA GOMMATA, 445D TERNA GOMMATA, 545D TERNA GOMMATA, 550 - 555 - 535 TERNA GOMMATA, 555B TERNA GOMMATA, 555D TERNA GOMMATA, 575D TERNA GOMMATA, 655 - 655A TERNA GOMMATA, 655D TERNA GOMMATA, 675D TERNA GOMMATA, L 781 MINI PALE, L 783 MINI PALE, L 785 MINI PALE, L 865 MINI PALE, L5180 SKID STEER LOADER, LX885 - LX865	84259320, 87800068	

**FILTRI OLIO MOTORE ORIGINALI**

FILTRE A HUILE ORIGINAL  
 OIL FILTERS ORIGINAL  
 OELFILTER ORIGINAL  
 FILTROS ACEITE ORIGINAL

Art./Ref.	Brand	Rif. Orig./Orig. Ref.
NH1909101	NEW HOLLAND	1909101
NH1909102		1909102, 84221215
NH1909104		1909104, 47456137
NH1930544		1930544
NH1931047		1931047
NH1931048		1931048
NH47135703		47135703
NH81879134		81879134
NH84228488		2854749, 84228488
NH84588864		1909123, 84588864
NH87679598		87679494, 87679598
NH87800068		84259320, 87800068



**FILTRO OLIO ADATTABILE**

OIL FILTER A' L'HUILE ADAPTABLE  
 OIL FILTER ADAPTABLE  
 OELFILTER A' L'HUILE PASSNED ZU  
 FILTRO ACEITE ADAPTABLE

Art./Ref.	Brand	Applicazione/Application	Rif. Orig./Orig. Ref.	Immagine/Image
51834	DEUTZ	Agrostar DX4.61, DX4.71, Agroxtra 4.17, Agroxtra 4.47, Agroxtra 6.07, Agroxtra F6L912, Agroxtra 4.07, Agroxtra 6.17, Agroxtra BF4L913, Agroxtra F6L13, C-Serie von D4507 bis D7207, D4006 bis, D7206, D4007 bis, D7207, D7807, D7807C, DX3.10 bis, DX3.90, DX4.10 bis, DX4.70, DX50, DX80, DX86, DX92, Intrac 2002, Intrac 2003	01173481	
51838		Agroplus 100, Agrostar DX6.11, Agrottron 150, Agrottron 6.20, Agrottron 6.30, Agrottron 6.45, Agroxtra 4.17, Agroxtra 4.47, Agroxtra 6.07, Agroxtra F6L912, Agroxtra 4.07, Agroxtra 6.07, Agroxtra 6.17, Agroxtra BF4L913, Agroxtra F6L13, D10006, D13006, D8006, D9006, DX1.10, DX120, DX230, DX6.10, DX6.30, DX85, DX90, Intrac 2005, Intrac 2006, Intrac 6.30 Turbo	01174421, 01183574	
53202		Agrostar DX6.61, DX140, DX145, DX160, DX250, DX6.50, DX7.10, DX8.30	01174420	
02039	SAME	BUFFALO 120 2RM-4RM, BUFFALO 130, DRAGO 100	2.4419.170.1	

Art./Ref.	Brand	Applicazione/Application	Rif. Orig./Orig. Ref.	Immagine/Image
02041		ANTARES 100, ANTARES 130, ARGON 70, ASTER 70, DORADO, DORADO CLASSIC, DORADO F, DORADO S, EXPLORER II SPECIAL, EXPLORER T-TB, KRYPTON, KRYPTON F, LASER, LEOPARD 90 TURBO, ROW CROP 90, RUBIN 120, RUBIN 135, RUBIN 150, SILVER 100.4, SILVER 110, SILVER 130, SILVER 90	2.4419.340.0/10	
15403	SAME	ARIETE 137	2.4419.041.1	
26781		ARIETE 137, DELFINO 32, DELFINO 35, DELFINO 35 FRUTTETO, FOX 35 - 45 - 55, SIRENETTA, VIGNERON 35 - 45 - 50	2.4419.140.1	
26782		CONDOR C, MINITAURO 60, MINITAURO 60 FRUTTETO, MINITAURO C, RANGER 45, RANGER 45 FRUTTETO, SATURNO 80, SOLAR 50	2.4419.150.1	
02051		70C ERGOMATIC, 75C ERGOMATIC, ARGON 50 - 60, ASTER 60, ASTER 70 TURBO, C554-C554 COMPACT ERG LAMBORG, C664-C660 F-V LAMBORGHINI, C674.70 ERGOMATIC LAMBORGHINI, C774.80 ERGOMATIC LAMBORGHINI, CENTAURO 70 - 70 SYNCRO, CENTURION 75, CONDOR 55 - 55 SYNCRO, CONDOR C, CORSARO 60, CORSARO 70 - 70 SYNCRO DT, CORSARO 70 FRUTTETO, CRONO 50 - 60, EXPLORER 55 - 60 - 60 II, EXPLORER 60 DT - FRUTTETO, EXPLORER 60 SPECIAL, EXPLORER 65C ERGOMATIC, EXPLORER 70 - 70C SPECIAL, EXPLORER 70C - 80C - 90C, EXPLORER 75 FRUTTETO, EXPLORER 80 II, EXPLORERE 65 - 75, EXPLORERE 80 SPECIAL - BASSO, FALCON C, FRUTTETO 60, GOLDEN 60 - 65 - 75 - 85, H372-H372DT HURLIMANN, H468-H468 CLUB HURLIMANN, H476-H476 FRUTTETO HURLIMANN, H478-H478.4-H478 PRESTIGE HURL, LEOPARD 85 - 85 EXPORT, LEOPARD C, MERCURY 85 EXPORT - SPECIAL, MINITAURO 60 - 60C FRUTTETO, MINITAURO 60 SYNCRO, R1106-R1106DT LAMBORGHINI, R240 LAMBORGHINI, R345-C554-R660-R660DT LAMBORG, R574.60N-R674.70N LAMBORGHINI, R600-R600DT-R684-C684 LAMBORG, R653-R654-R654DT LAMBORGHINI, R674.70 GRAN PRIX LAMBORGHINI, R674.70 LAMBORGHINI, R683 LAMBORGHINI, R700-R700DT LAMBORGHINI, R754-R754DT-R754 ERGOM LAMBOR, R774.80-R774.80 GRAN PRIX LAMB, R775 F-V LAMBORGHINI, R775 FRUTTETO LAMBORGHINI, R784-C784-R854-R854DT LAMBORG, R956-R956DT LAMBORGHINI, R956.100 LAMBORGHINI, ROW CROP 80 - 85, SATURNO 80 - SYNCRO, SILVER 80 - 90, SOLAR 55 - 55C, SOLAR COMPACT 60 - 60C ERGOMAT, VIGNERON 60 - 70	0.044.1554.0, 0.044.1567.0/10	
08250	SAME LAMBORGHINI HURLIMANN	AURORA 45 2RM - 2RM VIGNETO, C353L-C353LL LAMBORGHINI, C503-C603 LAMBORGHINI, CENTAURO 60 - CENTAURO 65, CL653-C653L LAMBORGHINI, CONDOR C, CORSARO 70, FALCON 2RM FALCON 4RM, FALCON 50, FALCON C, FALCON CC - CL - CN, LEONE 70 - LEONE 75, MINITAURO 55, MINITAURO 60 - MINITAURO 60 F, MINITAURO C, R483 LAMBORGHINI, R500-R500DT LAMBORGHINI, R550DT LAMBORGHINI, RANGER 45 - RANGER 45 FRUTTETO, SOLAR 50, TAURUS C, VIGNERON 45 - VIGNERON 50	2.4419.150.1	
26781		C352 - C352L LAMBORGHINI, C352S - C352SL LAMBORGHINI, C483 LAMBORGHINI, R235 - R235 DT LAMBORGHINI	2.4419.140.1	

**FILTRI OLIO MOTORE ORIGINALI**

FILTRE A HUILE ORIGINAL  
 OIL FILTERS ORIGINAL  
 OELFILTER ORIGINAL  
 FILTROS ACEITE ORIGINAL

Art./Ref.	Brand	Rif. Orig./Orig. Ref.
V01183574	DEUTZ	01174421, 01183574
V02931092		02931092
V0.041.1556.0	SAME	0.041.1556.0
V0.044.1567.0/1		0.044.1567.0/1
V2.4419.140.1		2.4419.140.1
V2.4419.150.1		2.4419.150.1
V2.4419.340.0/1		2.4419.340.0/1



**FILTRI OLIO ADATTABILI**

FILTRE A' HUILE ADAPTABLE  
 OIL FILTER ADAPTABLE  
 OELFILTER PASSEND ZU  
 FILTRO ACEITE ADAPTABLE

Art./Ref.	Brand	Applicazione/Application	Rif. Orig./Orig. Ref.	Immagine/Image
53272	JOHN DEERE	SERIE 5510 - 5515 - 6010	RE59754	
51832		1020, 1030, 1040, 1120, 1130, 1140, 1350, 1550, 1630, 1640, 1750, 1850, 1950, 2020, 2030, 2040, 2040s, 2140, 2250, 2550, 2650, 2850, 3020, 3030, 3040, 3050, 3100, 3130, 3140, 3200, 3300, 3350, 3400, 3640, 3650, 4020, 4030, 4040, 4040S, 4050, 6359, 5000-5310-5315-5410, 6000, 6100, 6200, 6300, 6400, 6500, 6600, 6800, 6900, 820, 830, 840, 920, 930, 940, GOLDONI MOTOR J. DEERE 3 E 4 CIL	T19044	
85521		SERIE 4055, SERIE 7010, SERIE 8000, SERIE 8010	RE57394	
85522		SERIE 5020, SERIE 5M, SERIE 6020, SERIE 6030, SERIE 6M, SERIE 6R, SERIE 7430, SERIE 7530, SERIE SE6020	RE504336	

**FILTRI OLIO MOTORE ORIGINALI**

FILTRE A HUILE ORIGINAL  
OIL FILTERS ORIGINAL  
OELFILTER ORIGINAL  
FILTROS ACEITE ORIGINAL



Art./Ref.	Brand	Rif. Orig./Orig. Ref.
JDRE519626	JOHN DEERE	RES18977, RES19626
JDRE504836		RES04836, RES41420
JDRE509672		RES09672
JDAL203061		AL203061
JDRE57394		RES7394
JDRE59754		RES9754
JDJDT19044		T19044

**FILTRO OLIO ADATTABILE**

FILTRE A HUILE ADAPTABLE  
OIL FILTER ADPTABLE  
OELFILTER PASSEND ZU  
FILTRO ACEITE ADAPTABLE

Art./Ref.	Brand	Applicazione/Application	Rif. Orig./Orig. Ref.	Immagine/Image
08250	LANDINI	<p>ADVANTAGE CABINATO: 65F, ADVANTAGE CABINATO: 65GT, ADVANTAGE CABINATO: 65L, ADVANTAGE CABINATO: 75F, ADVANTAGE CABINATO: 75GT, ADVANTAGE CABINATO: 75L, ADVANTAGE CABINATO: 85F, ADVANTAGE CABINATO: 85GT, ADVANTAGE CABINATO: 85L, ADVANTAGE CABINATO: L95GT, ADVANTAGE F.S: 65FP/LP/GT, ADVANTAGE F.S: 75FP/LP/GT, ADVANTAGE F.S: 85FP/LP/GT, ATLAS: 100, ATLAS: 70, ATLAS: 75, ATLAS: 80, ATLAS: 85, ATLAS: 90, BLIZZARD: 65, BLIZZARD: 75, BLIZZARD: 85, BLIZZARD: 95, CINGOLATI C:C6500, CINGOLATI C:C6830, CINGOLATI C:C7800, CINGOLATI C:C7830, CINGOLATI C:C8860, CINGOLATI C:CF6830, FRUTTETI 530 F/L/V: 6530 F/L/V, FRUTTETI 530 F/L/V: 7530 F/L, FRUTTETI 560 F/L/V: 6560 F/L/V, FRUTTETI 560 F/L/V: 7560 F/L, FRUTTETI 560 F/L/V: 8560 F/L, GHIBLI: 100, GHIBLI: 90, GHIBLI: 80, GLOBUS: 55, GLOBUS: 65, GLOBUS: 75, GLOBUS: 80, LARGE: 14500, LARGE: 16000, LARGE: 16500, LEGEND N/G TDI: 125, LEGEND N/G TDI: 135, LEGEND N/G TDI: 145, LEGEND N/G TDI: 165, LEGEND N/G TDI: 185, MYTHOS NEW TIER 2: 115, MYTHOS: 100, MYTHOS: 90, POWER FARM: 60, PRIMI MODELLI 8000R-DT-S, REX CABINATI: 100, REX CABINATI: 60, REX CABINATI: 70, REX CABINATI: 80, REX CABINATI: 90, REX FOOT STEP: 100FP-LP-GTP-GE, REX FOOT STEP: 60FP-LP-GE, REX FOOT STEP: 70FP-LP-GTP-GE, REX FOOT STEP: 80FP-LP-GTP-GE, REX FOOT STEP: 90FP-LP-GTP-GE, REX NEW TIER 2: 60 F/G, REX NEW TIER 2: 70 F/G, REX NEW TIER 2: 75 F/GT/GE, REX NEW TIER 2: 80 F/G, REX NEW TIER 2: 85 F/G/GE, SERIE 30: 6830, SERIE 30: 7830, SERIE 30: 8830, SERIE 40: 6840, SERIE 500: 6500, SERIE 500: 7500, SERIE 500: 8500, SERIE 50: 6550, SERIE 50: 7550, SERIE 50: 8550, SERIE 60 NEW: 5860, SERIE 60 NEW: 6860, SERIE 60 NEW: 7860, SERIE 60 NEW: 8860, SERIE 60: 6860, SERIE 60: 7860-7860HC, SERIE 60: 8860-8860HC, SERIE 60: 9060, SERIE 70: 6870, SERIE 70: 7870, SERIE 70: 8870, SERIE 80: 6880, SERIE 80: 7880, SERIE 80: 8880-8880HC, SERIE 80: 9080-9080HC, SERIE 80: 9880-9880HC, TREKKER NEW 100C, TREKKER NEW 70 C/F/L, TREKKER NEW 80 C/F/L, TREKKER NEW 90 C/F/L, TREKKER: C75, TREKKER: C85, TREKKER: C95, TREKKER: CF65, TREKKER: CF70, TREKKER: CF75, TREKKER: CF85, VIGNETI CABINA V.Q: 65V, VIGNETI CABINA V.Q: 75V, VIGNETI F.S: 65V, VIGNETI FOOT STEP: 75V, VIGNETI REX CAB.TIER 2: 75V, VIGNETI REX CAB.TIER 2: 85V, VIGNETI REX CAB: 60V, VIGNETI REX CAB: 70V, VIGNETI REX CAB: 80V, VISION: 100, VISION: 80, VISION: 90</p>	2654403, 2654404, 2654405, 3540049M91, E3540049M91	

Art./Ref.	Brand	Applicazione/Application	Rif. Orig./Orig. Ref.	Immagine/Image
11257	LANDINI	ADVANTAGE CABINATO:55F, ADVANTAGE CABINATO:55GT, ADVANTAGE CABINATO:55L, ADVANTAGE CABINATO:60F, ADVANTAGE CABINATO:60GT, ADVANTAGE CABINATO:60L, ADVANTAGE FOOT STEP:55FP-LP-GT, ADVANTAGE FOOT STEP:60FP-LP-GT, BLIZZARD:50, BLIZZARD:60, CINGOLATI :CF4830, CINGOLATI :CF5030, CINGOLATI :CF5830, CINGOLATI :CF6030, CINGOLATI :CF6060, CINGOLATI C:C4500, CINGOLATI C:C4830, CINGOLATI C:C5000, CINGOLATI C:C5500, CINGOLATI C:C5830, CINGOLATI C:C6000, FRUTTETI 530 F-L-V:4530V, FRUTTETI 530 F-L-V:5530 F-L-V-, FRUTTETI 530 F-L-V:6030 F-L-V-, FRUTTETI 560 F-L-V: 4560V, FRUTTETI 560 F-L-V: 5560 F-L-V, FRUTTETI 560 F-L-V: 6060 F-L-V, GLOBUS:50, PRIMI MODELLI 4000 SPECIAL, PRIMI MODELLI 5000R-DT-S-N, SERIE 30:5830, SERIE 30:6030, SERIE 40:5840, SERIE 40:6040, SERIE 500:5500, SERIE 60:5860, SERIE 60:6060, SERIE 70:5870, SERIE 70:6070, TREKKER C.F.:CF55, TREKKER C.F.:CF60, VIGNETI CABINA V.Q: 55V, VIGNETI CABINA V.Q: 60V, VIGNETI FOOT STEP:55V, VIGNETI FOOT STEP:60V	2654408, 3541579M1, E3541579M1	
11259		CINGOLATI C:C10500, GIBLI NEW TIER 2:105, GIBLI NEW TIER 2:85, GIBLI NEW TIER 2:95, LARGE:10000, LARGE:10000S, LARGE:12500, LARGE:13000, LEGEND N/G:115, LEGEND N/G:120, LEGEND N/G:130, LEGEND N/G:140, LEGEND N/G:160, LEGEND N/G:180, LEGEND:105, LEGEND:115, LEGEND:130, LEGEND:145, LEGEND:165, MYTHOS NEW TIER 2:105, MYTHOS:110, POWER FARM:105, POWER FARM:75, POWER FARM:85, POWER FARM:95, REX NEW TIER 2 :105 F-GT-GE, REX NEW TIER 2 :95 F-GT-GE, SERIE 500:9500R-DT, TREKKER NEW TIER 2:105, TREKKER NEW TIER 2:75, TREKKER NEW TIER 2:85, TREKKER NEW TIER 2:95, VISION NEW TIER 2: 105, VISION NEW TIER 2: 85, VISION NEW TIER 2: 95, VISION:100	2654407, 3541580M1, E3541580M1	
11265		CINGOLATI C:C4500, CINGOLATI C:C5000, CINGOLATI C:C5500, CINGOLATI C:C6000, PRIMI MODELLI 4000 R-DT, PRIMI MODELLI 4000 SPECIAL, PRIMI MODELLI 4500 R, PRIMI MODELLI 5000R-DT-S-N, PRIMI MODELLI 6000R-DT-S, PRIMI MODELLI 7000R-DT, SERIE 500:5500	26540132	
11266		CINGOLATI C:C6500, PRIMI MODELLI 7000 SPECIAL, PRIMI MODELLI 8000R-DT-S, SERIE 500:6500, SERIE 500:7500, SERIE 500:8500	26560090	

**FILTRI OLIO MOTORE ORIGINALI**

- FILTRE A HUILE ORIGINAL
- OIL FILTERS ORIGINAL
- OELFILTER ORIGINAL
- FILTROS ACEITE ORIGINAL



Art./Ref.	Brand	Rif. Orig./Orig. Ref.
LN3540049M91	LANDINI	3540049M91
LN3678034M2		3678034M2
LNE3541579M1		E3541579M1
LNE3541580M1		E3541580M1

**FILTRI OLIO ADATTABILI**

FILTRE A' HUILE

OIL FILTER ADAPTABLE

OELFILTER PASSEND ZU

FILTRO ACEITE ADPTABLE

Art./Ref.	Brand	Applicazione/Application	Rif. Orig./Orig. Ref.	Immagine/Image
<b>08250</b>		1080 A4.318, 165 A4.212, 168 A4.236, 175 A4.236, 178 A4.248, 185 A4.248, 265 A4.236, 2680 AT6.354.4, 2685 AT6.354.4, 2720 AT6.354.4, 2725 AT6.354.4, 275 A4.236, 285 A4.248, 285 A4.318, 290 A4.248, 294 A4.248, 298 A4.318, 3050 A4.236, 3060 A4.248, 3065 A4.236, 3070 A4.236, 3125 1006.6T, 3140 1006.6T, 362 A4.236, 3630 AT6.534.4, 3635 1006.6T, 3645 AT6.354.4, 365 A4.236, 3650 AT6.354.4, 3655 1006.6T, 3660 1006.6T, 372 A4.236, 375 A4.236, 387 A4.248, 390 A4.248, 390T A4.236, 398 A4.236, 4225 1004.4, 4225 4.41, 4235 1004.4, 4235 4.41, 565 A4.236, 575 A4.236, 590 A4.248, 595 A4.318, 6110 4.41, 6120 4.41, 675 A4.236, 690 A4.248, 698 A4.318, 698T A4.236, 8120 1006.6T <F, 8130 1006.6T	1447048M1, 2862642M1, 836064M91, 881304M91	
<b>11257</b>		135 AD3.152, 148 AD3.152, 155 AD4.203, 158 AD4.203, 165 AD4.203, 230 AD3.152, 235 AD3.152, 240 AD3.152, 250 AD3.152, 255 AD3.152, 260 AD4.203, 340 AD3.152, 342 AD3.152, 35 A3.152, 350 AD3.152, 352 AT3.152, 355 AT3.152, 360 AT3.152, 550 AD3.152, 560 AD4.203, 65 A4.203, 65 AD4.203, 765 AD4.203	1447082M91, 363848M1	
<b>11259</b>		1100 A6.354.1, 1105 A6.354.4, 1135 A6.354.4, 1200 A6.354.1, 1250 A6.354.4, 2620 A6.354.4, 2625 A6.354.4, 2640 A6.354.4, 2645 A6.354.4, 2680 AT6.354.4, 3075 1004.4, 3075 A4.236, 3080 A6.354.4, 3085 1006.6, 3090 A6.354.4, 3095 1006.6, 3115 1006.6, 3120 1006.6T, 3120T 1006.6T, 3125 1006.6T, 3140 1006.6T, 3610 A6.354.4, 3635 1006.6T, 3645 1006.6T, 399 1006.6, 399 A6.354.4, 4245 1004.4T, 4255 1004.4T, 4255 4.41, 4260 1006.6, 4270 1006.6, 6130 1004.4T, 6140 1004.4T, 6150 1004.4T, 6160 1006.6, 6160 1006.6T, 6170 1006.6, 6170 1006.6T, 6180 1006.6T, 6190 1006.6T, 699 A6.354.4, 8110 1006.6T, 8120 1006.6T FO	1447031M1, 1447031M2	
<b>11265</b>		135 AD3.152, 148 AD3.152, 155 AD4.203, 158 AD4.203, 165 AD4.203, 35 A3.152, 65 A4.203, 65 AD4.203, 765 AD4.203	1640996M91, 1852251M91, 1854766M1, 185766M1, 1881842M1, 1883258M91, 835568M91, 835568M92, 837595M91, 852251M91, 894972M91, 894975M91, 968614M91, 973118M91	
<b>11266</b>	<b>MASSEY FERGUSON</b>	1080 A4.318, 165 A4.212, 168 A4.236, 175 A4.236, 178 A4.248, 185 A4.248	1882916M1, 1896000M91	
<b>40322</b>		FE35 4cil 23C, TEF20 4cil 20C	894976M91	
<b>40323</b>		M10 SERIE 31, MF100 SERIE 630 (MD630), MF100 SERIE 630S (MD630S)	26541054	
<b>40428</b>		1100 A6.354.1, 1105 A6.354.4, 1135 A6.354.4, 1200 A6.354.1, 1250 A6.354.4, 2620 A6.354.4, 2625 A6.354.4, 2640 A6.354.4, 2645 A6.354.4, 2680 AT6.354.4, 3075 1004.4, 3075 A4.236, 3080 A6.354.4, 3085 1006.6, 3090 A6.354.4, 3095 1006.6, 3115 1006.6, 3120 1006.6T, 3120T 1006.6T, 3610 A6.354.4, 3645 1006.6T, 399 1006.6, 399 A6.354.4, 4245 1004.4T, 4255 1004.4T, 4255 4.41, 4260 1006.6, 4270 1006.6, 6130 1004.4T, 6140 1004.4T, 6150 1004.4T, 6160 1006.6, 6160 1006.6T, 6170 1006.6, 6170 1006.6T, 6180 1006.6T, 6190 1006.6T, 699 A6.354.4, 8110 1006.6T	185233M1, 26540153	
<b>40675</b>		VARIOUS APPLICATION 60>90HP		



**FILTRO OLIO ADATTABILE**

FILTRE A' HUILE ADAPTABLE  
OIL FILTER ADAPTABLE P  
OELFILTER PASSEND ZU  
FILTRO ACEITE ADAPTABLE

Art./Ref.	Brand	Applicazione/Application	Rif. Orig./Orig. Ref.	Immagine/Image
08250	PERKINS	1004.40, 1004.40T, 1006.60, 1006.60T, 1103A-33, 1103A-33T, 1103C-33, 1103C-33T, 4.108, 4.212, 4.236, 900, T4.236, T6.354	2654403, 2654404, 2654405	
11257		SERIE MOTORI 3.152 E 3.1254 T	2654408	
11259		1004.40T, 1004.42, 1006.60, 1006.60T, 1104A-44, 1104A-44T, 1104C-44, 1104C-44T, 1104C-44TA, 1104D-44, 1104D-44T, 1104D-F44T, 1104D-F44TA, 4.108, 4.236, 6.354.4, T6.354.2, TV8.540, V8.540	2654407	
11265		A3.152, A4.192, A4.203, D3.152, DA.203	26540132, 32527	
11266		A4.212, A4.236, A4.248	26560090	
40322		AD-203	26540218	
40323		4.107A - 4.107M - 4.107V, 4.108 - 4.108M - 4.108V, 6.354 - 6.354.1 - 6.354.2, 6.354.2 - 6.354T/M/H/TA/V, A6.354 - H6.354V, T4.108 - 4.248.1A, V8.510	101606, 26540154, 26541054	
40428		C8.540	26540153	
70574		704.03	2654412	

**FILTRI OLIO MOTORE ORIGINALI**

FILTRE A HUILE ORIGINAL  
OIL FILTERS ORIGINAL  
OELFILTER ORIGINAL  
FILTROS ACEITE ORIGINAL



Art./Ref.	Brand	Rif. Orig./Orig. Ref.
PK140517050	PERKINS	140517050
PK2654403		2654403
PK2654407		2654407
PK2654408		2654408

**FILTRI OLIO ADATTABILI ALTRI MARCHI**

FILTRE A HUILE ADAPTABLE AUTRES MARQUES  
OIL FILTER ADAPTABLE OTHER BRANDS  
OELFILTER PASSEND ZU ANDERE MARKEN  
FILTRO ACEITE ADAPTABLE OTRAS MARCAS

Art./Ref.	Brand	Applicazione/Application	Rif. Orig./Orig. Ref.	Immagine/Image
08250	CLAAS	DOMINATOR 100-105, DOMINATOR 38-38S-48-48S, DOMINATOR 56-58S, DOMINATOR 68-68R-68S, DOMINATOR 88S-88SL-96	147.223.0, 147.225.0	
11259		COMMANDOR 112 CS, DOMINATOR 100-105, DOMINATOR 106-108S-112 CS, DOMINATOR 58S SPECIAL, DOMINATOR 66, DOMINATOR 68-68R-68S, DOMINATOR 76-76H-78-78S, DOMINATOR 80-80H-85-85H, DOMINATOR 86-88S	147.222.0	
26781		DOMINATOR 80-80H, DOMINATOR 85-85H	660.576.0	
40428		DOMINATOR 100 - 105, DOMINATOR 80 - 80H - 85 - 85H, MERCATOR 60 - 65 - 70	146.790.0	

Art./Ref.	Brand	Applicazione/Application	Rif. Orig./Orig. Ref.	Immagine/Image
08250		1, 105LSA, 106LSA, 106S, 108LSA, 108S, 10S, 11S, 2, 255GT, 3, 307, 308, 308LSA 178/01, 308LSA FWA 178/26, 309, 309LSA, 310, 310LSA, 311, 311LSA, 312, 312LSA, 3S FWA238/7, 4, 4S, 4S FWA 258/7, 510C, 5S FW 268, 600LSA, 610LSA, 611LSA, 811SL	F238202310010	
26781	FENDT	FARMER 1D, FIX 2E	F120203310170	
51834		200S, 201S, 203V, 204P, 205P, 240S, 250SA, 250VA, 275GT, 275VA, 280PA, 345GT, 360GT, 360GTH, 365GTA, 380GHA, 380GT, 380GTA	F100001173481, F27520301020	
02041		8061 I25	1901929	
10499	IVECO	8045-8065	1931047	
08250		103.14TX-103.14RS-106.14TX, 103.14TX-110.14TX-113.14TX, 106.14RS-321.4-421M, 113.12FS-113-14FS, 113.12TX-113.14TX, 113.14TS-133.14TX-145.14TX, 486-489-496, 75.12RS-75.12TS-75.14TS, 80.12-80.14-96.12-95.14-91.15, 95.12-103.12TX-103.12RS, R1181.4-68.12RS-68.14RS, R1451.4-R1451 TURBO, R651-R651S-R651.4-R652-R656, R681-R701.4F-R751-R752-R781, R781.4-R921-R951-R981-R782, R85.14LS-R95.12TX-R891-R921, R851-R851.4-R851.4S, R851-R95.14TX-R85.12LS, R90S-R90V-R90VE-R490S, R91TP-R94-R490-R98-R496-R555, R95.12TX-70.12SP-70.14SP, R95.14TX-R85.12LS-R85.14LS, R951.4-R981.4-R1151.4-R1181	770129280	
11257	RENAULT	501-4, 601-4	7701028406	
26782		-	7701029280	

Art./Ref.	Brand	Applicazione/Application	Rif. Orig./Orig. Ref.	Immagine/Image
40322	RENAULT	Super 7, Super 7D	0122672800	
40428		385	7701015133	
59837		MASTER 2, MASTER 4X4, R385 ALFA, R55, R57 - R88, SUPER 4 - SUPER 5, SUPER 5D	0854838600	
59841		ARES 540-550-610-620-630-640, CERES 65-70-70X-75-75X-85-85X, CERES 95-95X, CERGOS 330-340-350, ERGOS 105 MECA E HYDRO DPS, ERGOS 85, ERGOS 95 MECA E HYDRO	6005012109	
59843		R50-R51-R56-R60-R70-R80-R82, R53, R86-R456-R460-R486	7701002178	

**TABELLA COMPARAZIONI FILTRI OLIO PER CODICE AMA - ARTICOLI ADATTABILI ALLE SEGUENTI MARCHE**

TABLEAU COMPARAISONS DIESEL FILTRES A HUILE POUR CODE AMA  
 TABLE OF OIL FILTER COMPARISONS PER AMA CODE  
 KRAFTSTOFF OELFILTER VERGLEICHSTABELLE NACH AMA-CODE  
 TABLA COMPARACIONES FILTROS ACEITE PARA CODIGO AMA

Riferimento AMA	OEM	Riferimento COOPERS FIAAM	Riferimento Tecnocar	Riferimento M+H	Riferimento Donaldson	BALDWIN	Riferimento Fleetguard	Riferimento Ufi	CLEAN	NOTE
02039	1909101	FT4670T	R179	W8005	P55-1603	BT347		23.107.01	D0821	-
02040	1909130	FT4921, FT5236	R413	W1150/2, W1160/2	P556007, P559128	BT470 B75	LF3328, LF3565, LF3587	23.227.00	D0319	-
02041	1909102	FT 4669, FT4963, FT5046	R70	W1140/1	P55-3411	BT267	LF682	23.108.00	D0242	-
02051	0.044.1567.0/10	FT4627, FT4781, FT4803, FT5085	R64	W11007	-	BT5	LF580	2312400	D0224	-
08250	2654403	FT4863, FT4863A	R405, R406	W940/24 W940/27	P55-4403	B253, BT216	LF3466, LF701	2310202, 2318100	D0225/B	KUBOTA 16543-99170 STEYR 4060757
10499	1931047	FT5018, FT5018A, FT5119, FT5120	RD3000, RD3003, RD3004, RD3103	WP1144, WP1168	P55-0226	BD232, BD322, BD323, BD7120	LF3480, LF3481, LF3583	2330000, 2330300, 2330400	DF1898	-
11257	2654408, 1447082M91	FT4876	R57	W723/3, W818/2	P55-4408	BT215, BT353	LF700	2313800	D0294	LOMBARDINI 276.2175.36
11259	2654407	FT4805	R240	W938, W950/5, W950/7	P550299, P554407	BT217, BT237, BT251	LF697, LF699, LF787	2315600	D0298	-
11265	26540132, 837595M91	FA4247	OP813	-	P550184, P779073	PT108, PT108HD	LF596	2540201	ML077	-

Riferimento AMA	OEM	Riferimento COOPERS FIAAM	Riferimento Tecnocar	Riferimento M+H	Riferimento Donaldson	BALDWIN	Riferimento Fleetguard	Riferimento Ufi	CLEAN	NOTE
11266	26560090, 1882916M91	FA401/2D	OP801	H827/1n	P550183	P177, PT29	LF594	2540701, 2540702	ML013/A	-
15141	1909110	FB1234	O952		-	-	LF574	2001000	ML010	-
15403	1909123	FA4252	OP850	H943/2T	P551271, P779944	P235	-	25.401.00	ML018	-
15405	1930544	FT4804	R88	W1170, W1170/15	P550319, P551604	B263, BT349	-	2312000, 2312001	DO268	-
26781	2.4419.140.1	FT4512, FT4761, FT4776, FT4828, FT4828A	R171, R341, R61, R62, R84	W920, W920/12, W920/14, W920/17, W920/21, W920/22, W920/23, W920/26, W920/36, W920/6, W920/6(10), W920/7, W920/80	P550318, P550942, P550963, P551201, P551268, P551300	B163, B232, B233, B298, B34, B7152	LF3311, LF3341, LF3376, LF3377, LF3378, LF3400, LF764	2312401, 2312700, 2312702, 2312704, 2312706, 2313401, 2320100, 2329000	DO223	-
26782	2.4419.150.1	FT4905	R65	W940	-	-	-	-	DO225	-
27459	81879134	FT4777	R85	W950/17	P558250	B167, B7031, B7 089, B975, BT26 1, BT342	LF3307, LF3316, LF4017, LF4154, LF708, LF797	23.106.00, 23.152.00, 23.152.02	DO265	HENGST H28W01
35102	87800068	FT4809	R167, R206, R48	W930, W930/20, W930/7, W930/9, W932/80W930, W930/20, W930/7, W930/9, W932/80	P550941, P552290	B229	LF3353, LF4016, LF689, LF742	-	DO339	-
37997	1930892	FT5147	R42	W719/11		B161, B199	LF716	2315100, 2327200	DO289	-
40322	894976M91, 26540218	FA4009	OP820	-	P55-0052	566	LF566	2540800	ML031	-
40323	26540154	FA4303	OP836	H1029/1n	P55-1285	P15, PT195	LF599	2542100	ML 406	-
40428	185233M1, 26540153	FA4483	OP834	H1038X	P55-0185	PT12	LF598	2544400, 2545500	ML 061	-
51832	T19044	FT4580	R78	W936/4	P55-1307	BT259	LF678	2311200	DO281	HENGST H26W01
51834	01173481	FT4653	R67	W940/18, W940/29, W940/5	ELF7680, P552297, P552819, P555680, P559418	-	-	-	DO236	HENGST H17W10
51838	01183574	FT4657	R68	W962, W962/2, W962/6, W962/8	P553771	B236, B7143, B7193	LF3413, LF3625, LF3687, LF4054	2310601	DO263	-
53202	01174420	FT4879	R309	W11102, W11102/1, W11102/15	P551102, P551310	B218	LF3658, LF4112	2314401	DO874	-
53208	3136046R93	117	-	W930/15	P55-0719	B7220	LF3415	-	DO1830	HENGST H20W09
53222	RE59754	-	-	W925		B7125	-	-	-	-
59841	6005012109	FT4580	R78	W936/4	P55-1307	BT259	LF678	2311200	DO281	-
59843	7701002178	FA4381A	OP830	H720x	P55-1302	P107	LF779	2544200	ML029	-
70574	2654412	FT4863	R406	W930/20	-	B17403	-	-	DO339	-
85521	RE57394	LSF5036	-	-	P55-8329	BT352	LF3317	-	-	-
85522	RE504836	-	-	-	P55-0779	B7322	LF16243	-	-	-



# 1.7.3 Filtri idraulici

Hydraulic Filter



**Ricambi & accessori per macchine agricole**  
SPARE PARTS & ACCESSORIES FOR AGRICULTURAL MACHINE

Tutti gli articoli della presente sezione, prodotti da AMA SPA e/o da terzi per conto di AMA, sono adattabili ("non originali") alle marche indicate ai sensi di quanto previsto dal REG. CE n. 1400/2002. I diritti sui marchi citati appartengono ai legittimi proprietari e il loro uso ha l'esclusiva finalità di consentire all'utilizzatore la comparazione dei diversi prodotti.  
All items of this section, manufactured by AMA SPA and/or any third party on behalf of AMA, are adaptable ("non-original") to the brands listed under the provisions of the REG. CE n. 1400/2002. The rights on the trademarks belong to their respective owners and their usage is only aimed to allow the user to compare different products.

**FILTRI IDRAULICI ADATTABILI**

FILTRE HYDRAULIQUES ADAPTABLE  
HYDRAULIC FILTER ADAPTABLE  
KYDRAULIC FILTER PASSEND ZU  
FILTRO HIDRAULICO ADAPTABLE

Art./Ref.	Brand	Applicazione/Application	Rif. Orig./Orig. Ref.	Immagine/Image
02040		465C/V/F, 565C, 765C, SERIE 65 80.65C, SERIE 65 55.65C, SERIE 65 60.65C, SERIE 65 70.65C, SERIE 66 60.66/LP, SERIE 66 65.66, SERIE 66 80.66, SERIE 66 80.66/F, SERIE 66 55.66, SERIE 66 60.66, SERIE 66 70.66, SERIE 66 70.66/LP-F, SERIE 66 55.66/LP, SERIE 75 55.75C, SERIE 75 60.75C, SERIE 75 70.75C, SERIE 75 80.75C, SERIE 76 60.76/F, SERIE 76 70.76/LP-VF, SERIE 76 80.76/F, SERIE 85 55.85C, SERIE 85 60.85C, SERIE 85 88.85C, SERIE 85 72.85C, SERIE 85 82.85C, SERIE 85 62.85C, SERIE 86 72.86/LP-F, SERIE 86 82.86/LP-F, SERIE 86 62.86/F, SERIE 88 55.88, SERIE 88 60.88, SERIE 88 70.88, SERIE 88 80.88, SERIE 90 110.90, SERIE 90 100.90, SERIE 90 115.90, SERIE 90 160.90, SERIE 90 70.90, SERIE 90 85.90, SERIE 90 140.90, SERIE 90 180.90, SERIE 90 55.90, SERIE 90 60.90, SERIE 90 65.90, SERIE 90 90.90, SERIE 90 130.90, SERIE 90 115.90, SERIE 90 180.90, SERIE 90 80.90, SERIE 93 65.93, SERIE 93 72.93, SERIE 93 88.93, SERIE 93 60.93, SERIE 93 82.93, SERIE 94 72.94, SERIE 94 82.94, SERIE 94 88.94, SERIE 94 60.94, SERIE 94 65.94, SERIE 90 140.90	1909130, 1930918, 47425202, 5113297, 5136877, 84397845	
08437		120C, 1355C, 250 NASTRO ORO, 255,300,300DT,350,350 SPECIAL, 311C/CR,312C,315C,331RS,332C, 332RS,342,,351C,352C,, 355C, 355F,355CM, 400,420,420ST,440,440DT,455C, 411C,421,431C,441,451C, 455C,455C SUPER,460,460DT,460V, 455DAL,450,450DT/DAL/UTB, 465C,466,466DT,57QDT FRUTTETO-, 480,480DT,500,500DT/S, 505C, 540,540DT,550,555,480.8,480.8D, 70CI,70R,80CA,80R, 805C, 80C, 90C, SERIE 315 DIAMANTE, SERIE 66 35.66, SERIE DIAMANTE 415C/R/CL	1909134, 4975589, 5103031, 5103130, 595924, 598416	
10674	FIAT	SERIE 66 55.66/VF, SERIE 66 56.66S, SERIE 66 60.66/LP, SERIE 66 65.66, SERIE 66 80.66, SERIE 66 80.66/F, SERIE 66 55.66, SERIE 66 60.66, SERIE 66 70.66, SERIE 66 70.66/LP-F, SERIE 66 35.66, SERIE 66 45.66, SERIE 66 55.66/LP, SERIE 66 50.66, SERIE 75 60.75, SERIE 75 70.75, SERIE 75 80.75, SERIE 76 45.76/V, SERIE 76 60.76/F, SERIE 76 70.76/LP-VF, SERIE 76 80.76/F, SERIE 85 55.85, SERIE 85 60.85, SERIE 85 88.85, SERIE 85 72.85, SERIE 85 82.85, SERIE 85 62.85, SERIE 86 70.86/V, SERIE 86 72.86/LP-F, SERIE 86 82.86/LP-F, SERIE 86 50.86/V, SERIE 86 60.86/VF, SERIE 86 62.86/F, SERIE 88 55.88, SERIE 88 60.88, SERIE 88 70.88, SERIE 88 80.88, SERIE 90 110.90, SERIE 90 100.90, SERIE 90 115.90, SERIE 90 160.90, SERIE 90 70.90, SERIE 90 85.90, SERIE 90 140.90, SERIE 90 55.90, SERIE 90 60.90, SERIE 90 65.90, SERIE 90 90.90, SERIE 90 130.90, SERIE 90 180.90, SERIE 90 80.90, SERIE 93 65.93, SERIE 93 72.93, SERIE 93 88.93, SERIE 93 60.93, SERIE 93 82.93, SERIE 94 72.94, SERIE 94 82.94, SERIE 94 88.94, SERIE 94 60.94, SERIE 94 65.94	1909143, 4997992	
14907		352C, 355, 455, 505, 50C OM, 555, 605	1909133, 4975588, 5103029, 567233, 598415	
15111		TK 160-55	1930543, 79007957, 79032229	
15398		1000 DT E SUPER, 100C, 1300 DT, 850 DT	1909105, 44016885, 4989579, 5101733, 5106921, 84298916	



Art./Ref.	Brand	Applicazione/Application	Rif. Orig./Orig. Ref.	Immagine/Image
15399		SERIE 55 85.55.00, SERIE 55 95.55.00	1909106, 4998327, 5104874, 5106917	
15404	FIAT	SERIE 66 55.66/VF, SERIE 66 56.66S, SERIE 66 45.66, SERIE 66 50.66, SERIE 76 45.76/V, SERIE 86 70.86/V, SERIE 86 50.86/V, SERIE 86 55.86/VF, SERIE 86 60.86/VF	1930299, 5132049, 5149815	
15409		F100 - F100 DT, F110 - F110 DT, F115 - F115 DT, F120 - F120 DT, F130 - F130 DT, F140 - F140 DT	1930828, 1930882	
02040		4030, 4230, 4430, 8430, 8630, 8830	1909130, 47425202, 84397845	
10674		3010S, 3830, 3935, 4010S, 4030, 4135, 4230, 4430, 4635, 4835, 5010S	1909143, 4997992	
15404	FORD	3435 8035.06, 3830, 3935 8035.06, 4135 8035.06	1930299, 5132049, 5149815	
15409		8160, 8260, 8360	1930882	
22673		2310 BSD 326, 2600 BSD 326, 2610>01.81 BSD 329, 2610>01.82 BSD 329, 2810 BSD 326, 2910 BSD 329, 3230 BSD 332, 3430 BSD 332, 3600 BSD 329, 3610>01.81 BSD 332, 3610>01.82 BSD 332, 3900 BSD 332, 3910 BSD 332, 3930 BSD 333, 4100 BSD 331, 4110>01.81 BSD 333H, 4110>01.82 BSD 333H, 4130 BSD 333, 4600 BSD 333H, 4610>01.81 BSD 333H, 4610>01.82 BSD 333H, 4630 BSD 333H, 4830 BSD 442, 5030 BSD 442, 5110 BSD 444, 5600 10/80< BSD 444, 5600<09/80 BSD 444, 5610 BSD 444, 5700 10/80< BSD 444, 5700<09/80 BSD 442, 6410 BSD 444, 6610 BSD 444, 6710>09.80 BSD 444, 6710>10.80 BSD 444, 6810 BSD 444TS, 7410 BSD 444T, 7600 BSD 444TS, 7610 BSD 444TS, 7700 BSD 444TS, 7710 BSD 444TS, 7810 BSD 666, 7910 BSD 666, 8210 BSD 666, 8530 BSD 666, 8630 BSD 666T, 8730 BSD 666T, 8830 BSD 666TI, TW15, TW25, TW35, TW5	83912256, 84263773	

Art./Ref.	Brand	Applicazione/Application	Rif. Orig./Orig. Ref.	Immagine/Image
27457	FORD	5640 P.S. 4.4, 6640 P.S. 5.0, 7740 P.S. 5.0T, 7840 P.S. 6.6, 8160 M100 P.S. 7.5, 8240 P.S. 7.5, 8260 M115 P.S. 7.5, 8340 9/93 < P.S. 7.5T, 8340 < 8/93 P.S. 7.5, 8360 M135 P.S. 7.5T, 8560 M160 P.S. 7.5T, 8670 G170 P.S. 7.5T, 8770 G190 P.S. 7.5T, 8870 G210 P.S. 7.5T, 8970 G240 P.S. 7.5T	81863799	
27458		5610S, 5640 P.S. 4.4, 6610S, 6640 P.S. 5.0, 6810S, 7010, 7610S, 7740 P.S. 5.0T, 7840 P.S. 6.6, 8010, 8160, 8240 P.S. 7.5, 8260, 8340 9/93 < P.S. 7.5T, 8340 < 8/93 P.S. 7.5, 8360, 8560, TS 100 P.S. 5.0T, TS 110 P.S. 5.0T, TS 115 P.S. 6.6, TS 80 P.S. 5.0, TS 90 P.S. 5.0	81865736, 82005016	
27460		4635, 4835, 5635, 6635, 7635	1930986, 84399618	
42699		2310 BSD 326, 2600 BSD 326, 2610 > 01.81 BSD 329, 2610 > 01.82 BSD 329, 2810 BSD 326, 2910 BSD 329, 3230 BSD 332, 3430 BSD 332, 3600 BSD 329, 3610 > 01.81 BSD 332, 3610 > 01.82 BSD 332, 3900 BSD 332, 3910 BSD 332, 3930 BSD 333, 4100 BSD 331, 4110 > 01.81 BSD 333H, 4110 > 01.82 BSD 333H, 4130 BSD 333, 4600 BSD 333H, 4610 > 01.81 BSD 333H, 4610 > 01.82 BSD 333H, 4630 BSD 333H, 4830 BSD 442, 5030 BSD 442, 5110 BSD 444, 5600 10/80 < BSD 444, 5600 < 09/80 BSD 442, 5610 BSD 444, 5700 10/80 < BSD 444, 5700 < 09/80 BSD 442, 6410 BSD 444, 6610 BSD 444, 6710 > 09.80 BSD 444, 6710 > 10.80 BSD 444, 6810 BSD 444TS, 7410 BSD 444T, 7600 BSD 444TS, 7610 BSD 444TS, 7700 BSD 444TS, 7710 BSD 444TS, 7810 BSD 666, 7910 BSD 666, 8210 BSD 666, 8530 BSD 666, 8630 BSD 666T, 8730 BSD 666T, 8830 BSD 666TI	83912298, D8NNB486AA	
02040	NEW HOLLAND	60-65 V, 70-75, TD60D, TD70D, TD80D, TD90D, TD95D, TK100A, TK4020F, TK4020V, TK4030, TK4030F, TK4030V, TK4040, TK4040M, TK4050, TK4050M, TK4060, TK55-65 F, TK55-65 M, TK55-65 V, TK55-75 F, TK55-75 M, TK55-75 V, TK55-85 F, TK55-85 M, TK55-85 V, TK60-65, TK60-65 M, TK60-75, TK60-75 M, TK60-75 V, TK60-85 F, TK60-85 V, TK62-85, TK62-85 M, TK65F, TK65V, TK70-65, TK70-65 M, TK70-75 M, TK70FA, TK70VA, TK72-85, TK72-85 M, TK75F, TK75FA, TK75M, TK75MA, TK75V, TK75VA, TK76, TK76M, TK80-65, TK80-66 DT, TK80-75, TK80A, TK80MA, TK82-85 M, TK85, TK85M, TK88-85 M, TK90A, TK90MA, TK95M, TT65D	1909130, 47425202 84397845	
10674		SERIE L L65, SERIE L L60, SERIE L L75, SERIE L L85, TD55D, TD60, TD60D, TD65B, TD65D, TD70, TD70D, TD75D, TD80, TD80D, TD85D, TD90, TD90D, TD95, TD95D, TK100A, TK4020F, TK4020V, TK4030, TK4030F, TK4030V, TK4040, TK4040M, TK4050, TK4050M, TK4060, TK65F, TK65V, TK70FA, TK70VA, TK75F, TK75FA, TK75M, TK75MA, TK75V, TK75VA, TK76, TK76M, TK80A, TK80MA, TK85, TK85M, TK90A, TK90MA, TK95M, TL100, TL70, TL80, TL90, TS6000 - TS6040, TT55, TT65, TT65D, TT75	1909143, 4997992	
15399		TK 100-55, TK 85-55, TK 95-55	1909106	
15409		M100, M115, M135, M160, TM115, TM120, TM125, TM130, TM140	1930828, 1930882 5148698, 5164251, 5167243	

Art./Ref.	Brand	Applicazione/Application	Rif. Orig./Orig. Ref.	Immagine/Image
27457	NEW HOLLAND	SERIE MIETITREBBIE CR TIER 2, SERIE MIETITREBBIE CR TIER 3, SERIE MIETITREBBIE CR TIER 4, SERIE MIETITREBBIE CX, SERIE T6, SERIE T7.170, SERIE T7.210, T6010, T6020, T6030, T6040, T6050, T6060, T6070, TC55 - TC57 MIETITREBBIE, TM135, TM150, TM165, TM180, TM7010, TM7020, TM7030, TM7040, TRINCIE CARICATRI SERIE FR9000, TRINCIE CARICATRI SERIE FR, TS 100 P.S. 5.0T, TS 110 P.S. 5.0T, TS 90 P.S. 5.0, TS100A, TS110A, TS115A, TS125A, TS130A	81863799, 84226258	
27458		6010, SERIE M M100, SERIE M M115, SERIE M M135, SERIE M M160, TS.105, TS.115, TS.95, T6.120, T6.140, T6.150, T6.155, T6.160, T6.165, T6.175, T6020, T6030, T6050, T6070, TM115, TM120, TM125, TM130, TM135, TM140, TM150, TM155, TM165, TM175, TM180, TM190, TS100, TS100A, TS110, TS110A, TS115, TS115A, TS125A, TS130A, TS80, TS90	82005016, 84248043	
27460		L60, L65, L75, L85, L95, TL100, TL55F, TL60, TL60E, TL65, TL65A, TL65F, TL70, TL75, TL75E, TL75F, TL80, TL85, TL85E, TL90, TL95, TL95E	1930986, 47124379, 5171457, 84399618	
29391		T4030V, T4040V, T4050V, T4060V, TD5040, TD5050, TN55, TN55D, TN55S, TN65, TN65D, TN65F, TN65S, TN70, TN70D, TN70S, TN75, TN75D, TN75F, TN75S, TN90F	47131194, 5174044, 84257511	
41697		T4.75, T4.55, T4.65, T4020, T4020V, T4030, T4030, T4050, T4020, T4040, T4020, T4030N, T4030V, T4040F, T4030F, T4060F, T4050F, T4040N, T4040V, T4050, T4040, T4030,, TS.115-T5.95-T5.105, T5030, T5040, T5050, T5060, T5070, TD5040, TD5030, TD5050, TL90A, TL100A, TL80A, TL70A, TN60SA, TN85SA, TN70SA, TN75SA, TN60VA, TN75VA, TN70VA, TN95VA, TN70DA, TN60DA, TN70NA, TN95NA, TN75NA, TN95A, TN85DA, TN85FA, TN75FA, TN95FA, TN85SA, TN95A, TN75A, TN60A, TN70A, TN85A, TN95DA	47128161, 5194879	
42699		TC18D, TC21D, TC24D, TZ21D, TZ24D, TZ25DA	83912298	

**FILTRI IDRAULICI ORIGINALI**

FILTRE HYDRAULIQUES ORIGINAL  
HYDRAULIC FILTERS ORIGINAL  
HYDRAULIK FILTER ORIGINAL  
FILTROS HIDRAULICO ORIGINAL

Art./Ref.	Brand	Rif. Orig./Orig. Ref.
NH1909105	NEW HOLLAND	1909105, 84298916
NH1909106		1909106
NH1909134		1909134
NH1930986		1930986, 84399618
NH47425202		47425202
NH84257511		47131194, 84257511



**FILTRI IDRAULICI ADATTABILI**

FILTRE HYDRAUQUES ADAPTABLE

HYDRAULIC FILTER ADAPTABLE

KYDRAULIC FILTER PASSEND ZU

FILTRO HIDRAULICO ADAPTABLE

Art./Ref.	Brand	Applicazione/Application	Rif. Orig./Orig. Ref.	Immagine/Image
02040	SAME	ANTARES 100, ANTARES 110, ANTARES 130, CORSARO 70 FRUTTETO, EXPLORER 75, EXPLORER 75 SPECIAL, EXPLORER 80, EXPLORER 90 II SPECIAL, EXPLORER 90 SPECIAL, GALAXY 170, LEOPARD C, ROW CROP 100, ROW CROP 90	2.4419.270.0	
38563		ANTARES 100, ANTARES 110, ANTARES 130, ANTARES II 110, ANTARES II 130, DORADO 60, DORADO 65, DORADO 70, EXPLORER 75, EXPLORER 75 SPECIAL, EXPLORER 80, EXPLORER 90 II SPECIAL, EXPLORER 90 SPECIAL, IRON, IRON COM 3, IRON CONTINUO COM 3, IRON HI-LINE, IRON HI-LINE COM 3, ROW CROP 90, SAME ROCK 55, SAME ROCK 60, SILVER 100.4, SILVER 100.6, SILVER 110, SILVER 130, SILVER 80, SILVER 90, SOLAR 50, SOLAR 55 C, SOLAR 60, SOLAR 60 C	2.4419.350.0/10	
41697		DORADO F - S - V, GOLDEN 60, GOLDEN 65, GOLDEN 75, GOLDEN 85, TITAN	2.4419.611.0	
41698		GOLDEN 60 - 65 - 75 - 85	2.4419.721.0	
85468		SERIE CENTURION, SERIE CONDOR, SERIE EXPLORER I/II, SERIE LASER, SERIE MERCURY, SERIE SILVER, SERIE SOLAR, SERIE SOLARIS	2.4419.280.0/10	
85469		SERIE CENTURION, SERIE EXPLORER I/II, SERIE SILVER, SERIE TITAN	2.4419.320.0/20	
02040		SAME LAMBORGHINI HURLIMANN	C 483 LAMBORGHINI, C 583 - C 683 LAMBORGHINI, R 483 LAMBORGHINI, R 583 - R 1156 - R 1156 DT LAM, R 683 LAMBORGHINI, R1356 - R1356 DT LAMBORGHINI, R1506 DT TURBO LAMBORGHINI, R1556 DT LAMBORGHINI, R1706 DT TURBO LAMBORGHINI, R874.90 TURBO E GRAND PRIX LAM, R955 - R1256 LAMBORGHINI	2.4419.270.0
85468	SERIE H400, SERIE H5000, SERIE H6000		2.4419.280.0/10	

**FILTRI IDRAULICI ORIGINALI**

FILTRE HYDRAULIQUES ORIGINAL  
HYDRAULIC FILTERS ORIGINAL  
HYDRAULIK FILTER ORIGINAL  
FILTROS HIDRAULICO ORIGINAL

Art./Ref.	Brand	Rif. Orig./Orig. Ref.
V2.4419.270.0	SAME	2.4419.270.0
V2.4419.280.0/1		2.4419.280.0/1
V2.4419.320.0/2		2.4419.320.0/2
V2.4419.350.0/1		2.4419.350.0/1

**FILTRI IDRAULICI ADATTABILI**

FILTRE HYDRAULIQUES ADAPTABLE  
HYDRAULIC FILTER ADAPTABLE  
HYDRAULIK FILTER PASSEND ZU  
FILTRO HIDRAULICO ADAPTABLE

Art./Ref.	Brand	Applicazione/Application	Rif. Orig./Orig. Ref.	Immagine/Image
27457		6300, 6400, 6600, 6800, 6900, 7000-7010-7020 TRASM POWRQUAD	AL205726, RE39527	
85514	JOHN DEERE	1020, 1030, 10300U, 1030VU, 1035, 1035EF, 1035EV, 1040, 1040V, 1120, 1140, 1140F, 1140V, 1350, 1520, 1530, 1550, 1630, 16300U, 1630VU, 1635, 1635EF, 1635EV, 1640, 1640F, 1641 - 1641F, 1750, 1750V, 1840, 1840F, 1850, 1850F, 1850N, 1850V, 1950, 1950F, 1950N, 2020, 2030, 20300U, 2035, 2035EF, 2040, 2040F, 2040S, 2120, 2130, 2135, 2140, 2141 - 2541 - 2941, 2150, 2155, 2240, 2250, 2250F, 2251 - 2251N - 2351, 2350, 2355, 2355N, 2440, 2450, 2450F, 2510, 2520, 2550, 2555, 2630, 2640, 2650, 2650F, 2650N, 2651 - 2951, 2750, 2755, 2850, 2940, 2950, 2955, 300B, 3010, 301A, 302, 3020, 302A, 3040, 3050, 3055, 310A - 310B, 3130, 3135, 3140, 3141 - 3641, 3150, 3155, 3255, 3340, 3350, 3351 - 3651, 3640, 3640S, 3650, 4000, 4010, 401B, 401C, 401D, 4020, 4030, 410, 4230, 4320, 440 - 440A, 440 - 440A - 440B, 440C, 4430, 444, 444C, 4455, 4520, 4620, 4630, 480C, 500C, 5010, 5020, 510, 540 - 540A, 540B, 544B - 644B, 544C, 550, 550A, 550B, 555, 555A, 555B, 570 - 570A, 570B, 6030, 640, 644C, 646 - 646B, 646C, 7020, 743, 7520, 760, 820, 830, 840, 8430, 860 - 860A, 860B, 8630, 920, 93 - 93A - 94 - 95 - 95A, 9305, 930VU, 940, 940V, JD300 - JD400, JD301 - JD401, JD310, JD380, JD480, JD480A, JD500 - JD600, JD500-A, JD544 - JD544A, JD644A, JD700, JD740, JD760	AR75603	
85520		SERIE 5020, SERIE 5R, SERIE 5RN, SERIE 6000, SERIE 6010, SERIE 6020	AL118036	
85523		SERIE 6000, SERIE 6005, SERIE 6010, SERIE 6020, SERIE 6030, SERIE 6M, SERIE 6R, SERIE SE6010, SERIE SE6020	AL156625	

**FILTRI IDRAULICI ORIGINALI**

FILTRE HYDRAULIQUES ORIGINAL  
HYDRAULIC FILTERS ORIGINAL  
HYDRAULIK FILTER ORIGINAL  
FILTROS HIDRAULICO ORIGINAL

Art./Ref.	Brand	Rif. Orig./Orig. Ref.
JDAL118036	JOHN DEERE	AL118036
JDAL156625		AL156625
JDAL169573		AL169573
JDAR75603		AR75603
JDRE205726		RE205726



**FILTRI IDRAULICI ADATTABILI**

FILTRE HYDRAULIQUES ADAPTABLE

HYDRAULIC FILTER ADAPTABLE

KYDRAULIC FILTER PASSEND ZU

FILTRO HIDRAULICO ADAPTABLE

Art./Ref.	Brand	Applicazione/Application	Rif. Orig./Orig. Ref.	Immagine/Image
38563		LEGEND 105, 115, 130, 145, LEGEND N-G 115, 120, 130, 160, 180, LEGEND N-G 140, LEGEND N-G TDI 125, 135, 145, 165, REX V FOOT STEP 60, 65, 70, 80, VIGNETI CAB 55, 60, 65, 75, VIGNETI REX CAB 60V, 65V, 70V, 80, VIGNETI REX CAB TIER 75V, 85 V	3551956M91	
41697		ALPINE:65, CON INVERSOIRE MECCA, ALPINE:75, CON INVERSOIRE MECCA, ALPINE:85, CON INVERSOIRE MECCA, GHIBLI NEW TIER 2:105, GHIBLI NEW TIER 2:85, GHIBLI NEW TIER 2:95, GHIBLI:100, GHIBLI:80, GHIBLI:90, GLOBUS:70, GLOBUS:50, GLOBUS:55, GLOBUS:60, GLOBUS:65, GLOBUS:75, GLOBUS:80, LEGEND N/G:115, LEGEND N/G:120, LEGEND N/G:130, LEGEND N/G:140, LEGEND N/G:160, LEGEND N/G:180, LEGEND NG/TDI:125, LEGEND NG/TDI:135, LEGEND NG/TDI:145, LEGEND NG/TDI:165, LEGEND NG/TDI:185, LEGEND:145, LEGEND:105, LEGEND:115, LEGEND:130, LEGEND:165, MYTHOS NEW TIER 2:105, MYTHOS NEW TIER 2:115, MYTHOS:100, MYTHOS:110, MYTHOS:90, REX CAB:100, REX CAB:70, REX CAB:80, REX CAB:90, VISION NEW TIER 2:105, VISION NEW TIER 2:85, VISION NEW TIER 2:95, VISION:100, VISION:80, VISION:90	3656576M1	
41698		ALPINE:65, CON INVERSOIRE IDRAUL, ALPINE:75, CON INVERSOIRE IDRAUL, ALPINE:85, CON INVERSOIRE IDRAUL, LEGEND N/G:115, LEGEND N/G:120, LEGEND N/G:130, LEGEND N/G:140, LEGEND N/G:160, LEGEND N/G:180, LEGEND NG/TDI:125, LEGEND NG/TDI:135, LEGEND NG/TDI:145, LEGEND NG/TDI:165, LEGEND NG/TDI:185, LEGEND:145, LEGEND:105, LEGEND:115, LEGEND:130, LEGEND:165, MYTHOS NEW TIER 2:105, MYTHOS NEW TIER 2:115, MYTHOS:100, MYTHOS:110, MYTHOS:90, REX CAB:100, REX CAB:70, REX CAB:80, REX CAB:90, REX NEW TIER 2 FP CAB:105, REX NEW TIER 2 FP CAB:60, REX NEW TIER 2 FP CAB:70, REX NEW TIER 2 FP CAB:75, REX NEW TIER 2 FP CAB:80, REX NEW TIER 2 FP CAB:85, REX NEW TIER 2 FP CAB:95, VISION NEW TIER 2:105, VISION NEW TIER 2:85, VISION NEW TIER 2:95, VISION:100, VISION:80, VISION:90	3540378M1, 3619594M1	
58244	LANDINI	10000, 12500, 13000, 14500, 5860, 5870, 6060, 6070, 6860, 6870, 6880, 7860, 7870, 7880, 8860, 8870, 8880, 9060, 9080, 9880, ADVANTAGE:95, ADVANTAGE:55, ADVANTAGE:60, ADVANTAGE:65, ADVANTAGE:75, ADVANTAGE:85, ATLAS:100, ATLAS:70, ATLAS:75, ATLAS:80, ATLAS:85, ATLAS:90, BLIZZARD:50, BLIZZARD:60, BLIZZARD:65, BLIZZARD:75, BLIZZARD:85, BLIZZARD:95, FRUTTETI 530:4530, FRUTTETI 530:5530, FRUTTETI 530:6030, FRUTTETI 530:6530, FRUTTETI 530:7530, FRUTTETI 530:8530, FRUTTETI 560:5560, FRUTTETI 560:6060, FRUTTETI 560:6560, FRUTTETI 560:7560, FRUTTETI 560:8560, GHIBLI NEW TIER 2:105, GHIBLI NEW TIER 2:85, GHIBLI NEW TIER 2:95, GHIBLI:100, GHIBLI:80, GHIBLI:90, POWER FARM:105, POWER FARM:60, POWER FARM:75, POWER FARM:85, POWER FARM:95, REX CAB:100, REX CAB:60, REX CAB:70, REX CAB:80, REX CAB:90, REX FOOT STEP:100, REX FOOT STEP:60, REX FOOT STEP:70, REX FOOT STEP:80, REX FOOT STEP:90, SERIE 60 NEW:5860, SERIE 60 NEW:6860, SERIE 60 NEW:7860, SERIE 60 NEW:8860, TREKKER COMPACT TIER 2:CF60, TREKKER COMPACT TIER 2:CF70, TREKKER NEW TIER 2:105, TREKKER NEW TIER 2:75, TREKKER NEW TIER 2:85, TREKKER NEW TIER 2:95, TREKKER NEW:100C, TREKKER NEW:70C/F/L, TREKKER NEW:80C/F/L, TREKKER NEW:90C/F/L, TREKKER:C75, TREKKER:C85, TREKKER:C95, TREKKER:CF55, TREKKER:CF60, TREKKER:CF65, TREKKER:CF70, TREKKER:CF75, TREKKER:CF85, VIGNETI FOOT STEP:55V, VIGNETI FOOT STEP:60V, VIGNETI FOOT STEP:65V, VIGNETI FOOT STEP:75V	3530223M92	
58247		ALPINE, ALPINE TIER 3, GLOBUS, POWERFARM RPS TIER 2, POWERFARM RPS TIER 3, POWERMONDIAL, REX CAB, REX TECHNO RESTYLING, REX TECHNO TIER 2, REX TECHNO TIER 3, REX TIER 2, REX TIER 3, REX TOP RESTYLING, SERIE 5H, TREKKER NEW, TREKKER NEW TIER 2, TREKKER NEW TIER 3, TREKKER RESTYLING, VIGNETI REX CAB TIER 2, VIGNETI REX CAB TIER 3, VISION, VISION NEW TIER 2, VISION TIER 3	3555711M91	
70579		16500, 5500, 5830, 5840, 5860, 5870, 6030, 6040, 6060, 6070, 6500, 6550, 6830, 6840, 6860, 6870, 6880, 7500, 7550, 7830, 7860, 7870, 7880, 8500, 8550, 8830, 8860, 8870, 8880, CINGOLATI:C4500, CINGOLATI:C4830, CINGOLATI:C5500, CINGOLATI:C5830, CINGOLATI:C6500, CINGOLATI:C6830, CINGOLATI:C7800, CINGOLATI:C7830, CINGOLATI:C8860, CINGOLATI:CF4830, CINGOLATI:CF5030, CINGOLATI:CF5830, CINGOLATI:CF6030, CINGOLATI:CF6830, FRUTTETI 530:4530, FRUTTETI 530:5530, FRUTTETI 530:6030, FRUTTETI 530:6530, FRUTTETI 530:7530, FRUTTETI 530:8530, TREKKER:C75, TREKKER:C85, TREKKER:C95	3307250M91, 3386701M2	
70580		10000, 12500, 13000, 14500	3530222M91	
70584		MISTRAL AMERICA:40, MISTRAL AMERICA:45, MISTRAL AMERICA:50, MISTRAL AMERICA:55, MISTRAL:40, MISTRAL:45, MISTRAL:50, MISTRAL:55	4204121M1	

**FILTRI IDRAULICI ORIGINALI**

FILTRE HYDRAULIQUES ORIGINAL  
HYDRAULIC FILTERS ORIGINAL  
HYDRAULIK FILTER ORIGINAL  
FILTROS HIDRAULICO ORIGINAL

Art./Ref.	Brand	Rif. Orig./Orig. Ref.
LN3307250M91	LANDINI	3307250M91
LN3530223M92		3530223M92
LN3551956M91		3551956M91



**FILTRI IDRAULICI ADATTABILI**

FILTRE HYDRAULIQUES ADAPTABLE  
HYDRAULIC FILTER ADAPTABLE  
KYDRAULIK FILTER PASSEND ZU  
FILTRO HIDRAULICO ADAPTABLE

Art./Ref.	Brand	Applicazione/Application	Rif. Orig./Orig. Ref.	Immagine/Image
11938		1200 A6.354.4, 1250 A6.354.4, 135 AD3.152, 148 AD3.152, 165 A4.212, 165 AD4.203, 168 A4.236, 175 A4.236, 178 A4.248, 185 A4.248, 230 AD3.152, 235 AD3.152, 240 AD3.152, 250 AD3.152, 255 AD3.152, 265 A4.236, 275 A4.236, 285 A4.248, 285 A4.318, 290 A4.248, 298 A4.318, 340 AD3.152, 35 A3.152, 350 AD3.152, 355 AT3.152, 360 AT3.152, 362 A4.236, 365 A4.236, 375 A4.236, 390 A4.248, 390T A4.236, 398 A4.236, 399 1006.6, 399 A6.354.4, 550 AD3.152, 565 A4.236, 575 A4.236, 590 A4.248, 595 A4.318, 65 A4.203, 65 AD4.203, FE35 4cil 23C	1687042M91, 1810744M91, 1870199M91, 1870199M92	
41696		340 AD3.152, 350 AD3.152, 355 AT3.152, 360 AT3.152, 362 A4.236, 365 A4.236, 375 A4.236, 390 A4.248, 390T A4.236, 398 A4.236, 399 1006.6, 399 A6.354.4	3595175M1	
41697	MASSEY FERGUSON	MF 376 CF, MF 376 XCF, MF 376C, MF 396 C, MF 396 CF, MF 396 CT	3540341M1, 3615949M1	
41698		MF3050,3060,3065,3075,3085, MF3095,3120,3125,3315,3325, MF3330,3340,3350,3355,, MF3425,3435,3445,3455 VSF POW, MF3425,3435,3445,3455 VSF TRAC, MF6120,6130,6140,6150,6160,, MF6170,6180	3540378M1, 3619594M1	
41764		230 AD3.152, 240 AD3.152, 250 AD3.152, 260 AD4.203, 265 A4.236, 275 A4.236, 285 A4.248, 285 A4.318, 290 A4.248, 298 A4.318, 340 AD3.152, 342 AD3.152, 550 AD3.152, 560 AD4.203, 565 A4.236, 575 A4.236, 590 A4.248, 675 A4.236, 698 A4.318, 698T A4.236, 699 A6.354.4	1674984M92, 1810694M92	
41767		3050 A4.236, 3060 A4.248, 3065 A4.236, 3070 A4.236, 3075 1004.4, 3075 A4.236, 3080 A6.354.4, 3085 1006.6, 3090 A6.354.4, 3095 1006.6, 3115 1006.6, 3120 1006.6T, 3120T 1006.6T, 3125 1006.6T, 3140 1006.6T, 6110 4.41, 6120 4.41, 6130 1004.4T, 6140 1004.4T, 6150 1004.4T, 6160 1006.6, 6160 1006.6T, 6170 1006.6, 6170 1006.6T, 6180 1006.6T, 6190 1006.6T, 6235, 6245, 6255, 6260, 6265, 6270, 6280, 6290	3616579M2, 3907580M1, 4303303M1	

**TABELLA COMPARAZIONI FILTRI IDRAULICI PER CODICE AMA**

TABLEU COMPARAISONS FILTRE HYDRAULIQUES POUR CODE AMA

TABLE OF HYDRAULIC FILTERS COMPARISONS PER AMA CODE

LUFTFILTER VERGLEICHSTABELLE NACH AMA-CODE

TABLA COMPARACIONES FILTRO AIRE PARA CODIGO AMA

Riferimento AMA	OEM	Riferimento FIAAM	Riferimento Tecnocar	Riferimento M+H	Riferimento Donaldson	UFI	Note
02040	1909130	FT4921	R413	W1150/2	P55-6007	23.227.00	-
08437	1909134	FH3499	-	-	-	22.009.00	FLEETGUARD HF6274
10674	1909143	FH1548	-	-	-	21.021.00	FLEETGUARD HF28912
11938	1870199M91	-	-	H66/3X	-	-	-
14907	1909133	FH3258	Z267	-	-	-	-
15111	1930543	-	-	-	-	-	-
15398	1909105	FA4770	OP316	-	-	25.443.00	-
15399	1909106	FA4795	OP318	-	-	25.498.00	FLEETGUARD HF6268
15404	1930299	FT5017	-	-	P550420	-	FLEETGUARD LF3547
15409	1930882	-	-	HD1044/2	-	25.552.00	FLEETGUARD HF28914
22673	83912256	-	-	-	P77-9583	-	FLEETGUARD HF6115
27457	81863799	-	R263	WH980/3	P17-0950	-	FLEETGUARD HF6553
27458	82005016	-	-	-	P50-2224	-	FLEETGUARD HF28885
27460	1930986	FT5279	-	W1160/6	P76-4638	-	FLEETGUARD HF28833
29391	84257511	-	-	-	P76-5662	-	-
38563	2.4419.350.0/10	FT4944	-	WD11001	P76-4606	8.004.100	-
41696	3595175M1	-	-	W1019	P76-2476 P55-2476	-	FLEETGUARD HF28812
41697	3656576M1	-	-	-	P16-9447	-	-
41698	3540378M1	-	-	HD513/11	P76-2756	-	-
41764	1674984M92	-	-	-	-	-	-
41767	3616579M2	-	-	W13001	P76-4260	-	-
42699	83912298	-	-	-	P55-1323	-	FLEETGUARD HF6115
53245	1907641	FA5583	-	H615	-	-	-
58244	3530223M92	-	-	H816/1	-	-	-
58247	3555711M91	-	-	-	-	-	-
70579	3307250M91	-	-	-	-	-	-
70580	3530222M91	-	-	-	-	-	-
70584	4204121M1	-	-	-	-	-	-
85468	2.4419.280.0/10	FT4948	R415	WD11002	P763987	-	-
85469	2.4419.320.0/20	FT4952	R417	WD11003	P764607	-	-
85514	AR75603	FA4995	-	H12631	P555603	-	-
85520	AL118036	-	-	WH9801	P164378	-	-
85523	AL156625	-	-	WH945	P764668	-	FLEETGUARD HF6554



## 1.7.4 Filtri Aria

Air Filters



**ama**

**Ricambi & accessori per macchine agricole**  
SPARE PARTS & ACCESSORIES FOR AGRICULTURAL MACHINE

Tutti gli articoli della presente sezione, prodotti da AMA SPA e/o da terzi per conto di AMA, sono adattabili ("non originali") alle marche indicate ai sensi di quanto previsto dal REG. CE n. 1400/2002. I diritti sui marchi citati appartengono ai legittimi proprietari e il loro uso ha l'esclusiva finalità di consentire all'utilizzatore la comparazione dei diversi prodotti.  
All items of this section, manufactured by AMA SPA and/or any third party on behalf of AMA, are adaptable ("non-original") to the brands listed under the provisions of the REG. CE n. 1400/2002. The rights on the trademarks belong to their respective owners and their usage is only aimed to allow the user to compare different products.

**FILTRI ARIA ADATTABILI**

FILTRE AIR ADAPTABLE  
AIR FILTERS ADAPTABLE  
LUFILTER PASSEND ZU  
FILTROS AIRE ADAPTABLE

Art./Ref.	Note/Note	Brand	Applicazione/Application	Rif. Orig./Orig. Ref.	Immagine/Image
08283	Esterno/Outer	CASE	5110 >06/90, 5120 >06/90, 5130 >06/90, 5140 >06/90, 5230	1930765	
08284	Interno/Inner		4230A, 4240A, CVX 120, CVX 130, CVX 150, CVX 170, MAXXUM 5120, MAXXUM 5130, MAXXUM 5140	N8153	
15147	L. 353 mm. Esterno/ L. 353 mm. Outer		CX100, CX70, CX80, CX90	1930589, 222421A1	
15148	Interno/Inner		CX80, CX90, MX80C, MX90C	222422A1, CF990	
15183	Esterno/Outer		4230A, 4240A, MAXXUM 5120, MAXXUM 5130, MAXXUM 5140	700711907, C16335, D55864, D56453, D56463, E174631, L55204, N7698, S0850510	
42174	Interno/Inner		1066, 1466, 1486, 1566, 1586, 3388, 3588, 3788, 4786, 5288, 5488, 6388, 6588, 6788, 7288, 7488	81866982	-
42175			2500D, 2504, 3514D, 504	-	
42176	L.443mm. Interno/ L.443mm. Inner		1550	83913764	-
42177	L.475mm. Esterno/ L.475mm. Outer		1550	83913766	-
51846	Interno/Inner		260A, 3225, 433, 523, 523A, 533, 533A, 540, 633, 633 A/V/FWD, 640, 733, 733 A/FWD, 8045, 8045A, 8055, 8055A, 8060, 8060 A/T/TA, 8065, 8065 A, 8070, 8070 A, 8075, 8075A, 833, 840, 940, 942, 948, CS42	3148080R1	
51847	Interno/Inner	1046, 1046 A, 1055, 1055XL, 533, 544, 644, 644A, 743, 743 A/S/SA/XL/XLA, 744, 744A, 745S, 745XL, 745XL FWD, 8090, 8090 A, 8095, 8095 A, 824, 824 A, 833 N/S/XL, 844, 844 A/S/SA/XL/XLA, 844S, 844XL, 845 XL/XL FWD, 946, 946 A, 955, 955 A/XL/XLA, 956, 956 XL/XL FWD/XLA, 964, 964 A, 970, 970 A, 975, CS 55, CS 64, CS 68, CS 68A, CS 75, CS 75A	3147878R1		

Art./Ref.	Note/Note	Brand	Applicazione/Application	Rif. Orig./Orig. Ref.	Immagine/Image
51849	Esterno/Outer	CASE	260A, 3210A, 3220A, 3225, 323, 3230A, 4210A, 4220, 433, 453, 523, 523 A, 533, 533 A, 540, 624, 624 A, 633, 633 A/FWD/V, 724, 724 A, 733, 733 A/FWD, 8045, 8045 A, 8055, 8055 A, 8060, 8060 A, T/TA, 8065, 8065 A, 8070, 8070 A, 8075, 8075 A, 826, 826 A, 833, 833 A, 840, 846, 846 A, 940, 942, 948, CS 42	3142497R1, 3146927R1, C12155	
51850	Esterno/Outer		1046, 1046 A, 1055, 1055XL, 544, 644, 644A, 743, 743 A/S/SA/XL/XLA, 744, 744A, 8090, 8090 A, 8095, 8095 A, 824, 824 A, 844, 844 A/S/SA/XL/XLA, 955, 964, 964 A, 970, 970 A, 975, CS 68, CS 68A, CS 75, CS 75A	3146576R1	
53215	Interno/Inner		1055, 1055XL, 1056, 1056XL, 1102 D/PD, 1255, 1255 XL/XLA/XL FWD, 130M, 1455, 1455 XL/XLA/XL FWD/XL TURBO, 8150, 8150A, 8160, 8160A, 8165, 8165A, 8170, 8170A, 8180, 8180A, 9105A, 9115A, 9125A, 9145A, 955, 955 A/XL/XLA, 956, 956XL, CS100, CS110, CS110A, CS120, CS120A, CS130, CS150, CS150A	3219421R1	
53216	Esterno/Outer			3226416R1, C20325/2	
53975	Interno/Inner		1046, 1056, 1056XL/XLA, 1102, 1246, 1246A, 724, 8100, 8100A, 8110, 8110A, 8120, 8120A, 8130, 8130A, 8140, 8140A, 824, 856XL, 856XL TURBO, 9078 (M9078), 9083, 9086 (M9086), 9094 (M9094), 946, 955, 956 XL/XL FWD, CS78, CS86, CS94	3146939R91	
59833				383, 433, 533, 633, 440, 540	3146927R1, 3326416R1
02717	Esterno/Outer	FIAT	446, 465, 465C/VF, 466, 565, 565C, 570 >09/80, 665 MONTAGNA, 665C, 665C >01/82, 666, 666 >01/82, 670, 670 FRUTTETO, 765, 765C, 766, 766 >01/82, 775C, 980DT, SERIE 46 55.46, SERIE 46 55.46DT, SERIE 46 65.46, SERIE 65 45.65, SERIE 65 55.65, SERIE 65 55.65 MONTAGNA, SERIE 65 55.65 VIGNETO, SERIE 65 60.65, SERIE 65 60.65 VIGNETO, SERIE 65 70.65, SERIE 65 70.65 MONTAGNA, SERIE 65 80.65, SERIE 66 45.66, SERIE 66 45.66DT VIGNETO, SERIE 66 45.66S, SERIE 66 55.66, SERIE 66 55.66DT, SERIE 66 55.66LP, SERIE 66 60.66DT, SERIE 66 60.66LP, SERIE 66 60.66VF, SERIE 66 65.66, SERIE 66 70.66, SERIE 66 70.66DT, SERIE 66 80.66, SERIE 66 80.66F, SERIE 66 80.66LB, SERIE 75 55.75, SERIE 75 60.75, SERIE 75 70.75, SERIE 75 80.75, SERIE 76 55.76 >01/85, SERIE 76 60.76 >01/85, SERIE 76 70.76/LP_F, SERIE 76 80.76, SERIE 76 80.76/F, SERIE 76 80.76DT, SERIE 86 62.86/F, SERIE 86 72.86/LP_F, SERIE 86 82.86/LP_F, SERIE 88 55.88, SERIE 88 60.88, SERIE 88 70.88, SERIE 88 80.88, SERIE 90 55.90, SERIE 90 55.90DT, SERIE 90 60.90, SERIE 90 60.90DT	1909139	
02724	Interno/Inner		465C, 465C/V/F, 565C, 765C, SERIE 65 80.65C, SERIE 65 55.65C, SERIE 65 60.65C, SERIE 65 70.65C, SERIE 66 65.66, SERIE 66 70.66/LP-F, SERIE 66 50.66, SERIE 66 60.66, SERIE 66 60.66/LP, SERIE 66 80.66, SERIE 66 80.66/F, SERIE 66 55.66, SERIE 66 70.66, SERIE 66 45.66, SERIE 66 55.66/LP, SERIE 75 55.75C, SERIE 75 60.75C, SERIE 75 70.75C, SERIE 75 80.75C, SERIE 76 60.76/F, SERIE 76 70.76/LP-VF, SERIE 76 80.76/F, SERIE 86 72.86/LP-F, SERIE 86 82.86/LP-F, SERIE 86 62.86/F, SERIE 88 55.88, SERIE 88 60.88, SERIE 88 70.88, SERIE 88 80.88, SERIE 90 55.90, SERIE 90 60.90	1909138	
08284	Interno/Inner			1355C	73067508

Art./Ref.	Note/Note	Brand	Applicazione/Application	Rif. Orig./Orig. Ref.	Immagine/Image
10486	Esterno/Outer		SERIE 55 160.55.00, SERIE 90 115.90, SERIE 90 160.90, SERIE 90 140.90, SERIE 90 180.90, SERIE 90 130.90	1930174, 9960550	
10487	Interno/Inner		1180DT, 1380DT, SERIE 55 160.55.00, SERIE 90 115.90, SERIE 90 160.90, SERIE 90 140.90, SERIE 90 180.90, SERIE 90 130.90	1909135, 1930175, 9957888, 9960551	
10493			455, 505, 50C OM, 555, 605, 655, 655C, 805, SERIE 65 55.65, SERIE 65 60.65, SERIE 75 55.75, SERIE 75 60.75	4963663, 506922	
12959			465, 565, 765, 855, SERIE 55 85.55C, SERIE 65 80.65C, SERIE 65 60.65, SERIE 65 70.65, SERIE 66 65.66, SERIE 66 50.66, SERIE 66 60.66, SERIE 66 80.66, SERIE 66 55.66, SERIE 66 70.66, SERIE 66 45.66, SERIE 88 55.88, SERIE 88 60.88, SERIE 88 70.88, SERIE 88 80.88, SERIE 90 70.90, SERIE 90 55.90, SERIE 90 60.90, SERIE 90 65.90, SERIE 90 80.90	4987759, 8322103	
14886	Esterno/Outer		SERIE 66 65.66, SERIE 66 50.66, SERIE 66 56.66S, SERIE 66 80.66, SERIE 66 55.66, SERIE 66 60.66, SERIE 66 70.66, SERIE 66 45.66, SERIE 85 55.85, SERIE 85 60.85, SERIE 86 72.86/LP-F, SERIE 86 82.86/LP-F, SERIE 86 62.86/F, SERIE 93 72.93, SERIE 93 60.93, SERIE 93 65.93, SERIE 93 82.93, SERIE 94 60.94, SERIE 94 82.94, SERIE 94 65.94, SERIE 94 72.94	1930587, 47128154, 47135972	
14887	Interno/Inner/	FIAT	SERIE 66 50.66, SERIE 66 56.66S, SERIE 66 65.66, SERIE 66 80.66, SERIE 66 55.66, SERIE 66 60.66, SERIE 66 70.66, SERIE 66 45.66, SERIE 85 55.85, SERIE 85 60.85, SERIE 86 72.86/LP-F, SERIE 86 82.86/LP-F, SERIE 86 62.86/F, SERIE 93 72.93, SERIE 93 60.93, SERIE 93 65.93, SERIE 93 82.93, SERIE 94 60.94, SERIE 94 82.94, SERIE 94 65.94, SERIE 94 72.94	1930588, 47135975	
14888	Interno/Inner		S-WINNER F140, S-WINNER F130	1930790, 1930795, 1930897, 79114560	
14889	Esterno/Outer		S-WINNER F140, S-WINNER F130	1930603, 1930826, 71415282	
15021	Interno/Inner		400, 420, 805	1909114, 4958602	
15022	Esterno/Outer		400, 420, 805	1909111, 4958601	
15145	Esterno/Outer		SERIE 60 35.60, SERIE 60 35.60S, SERIE 65 80.65, SERIE 65 60.65, SERIE 65 70.65, SERIE 66 65.66, SERIE 66 45.66, SERIE 66 45.66DT, SERIE 66 60.66, SERIE 66 80.66, SERIE 66 80.66DT, SERIE 66 50.66, SERIE 66 50.66DT, SERIE 66 55.66, SERIE 66 70.66, SERIE 66 70.66DT, SERIE 76 80.76, SERIE 76 80.76DT, SERIE 88 55.88, SERIE 88 60.88, SERIE 88 70.88, SERIE 88 80.88, SERIE 93 72.93, SERIE 93 88.93, SERIE 93 60.93, SERIE 93 65.93, SERIE 93 82.93, SERIE 94 60.94, SERIE 94 82.94, SERIE 94 65.94, SERIE 94 72.94	1930536	

Art./Ref.	Note/Note	Brand	Applicazione/Application	Rif. Orig./Orig. Ref.	Immagine/Image
15146	Interno/Inner		SERIE 65 80.65, SERIE 65 60.65, SERIE 65 70.65, SERIE 66 65.66, SERIE 66 60.66, SERIE 66 80.66, SERIE 66 55.66, SERIE 66 70.66, SERIE 88 55.88, SERIE 88 60.88, SERIE 88 70.88, SERIE 88 80.88, SERIE 93 72.93, SERIE 93 88.93, SERIE 93 60.93, SERIE 93 65.93, SERIE 93 82.93, SERIE 94 60.94, SERIE 94 82.94, SERIE 94 65.94, SERIE 94 72.94, SERIE TD TD60D, SERIE TD TD65D, SERIE TD TD75D, SERIE TD TD85D, SERIE TK TK100A, SERIE TK TK76, SERIE TK TK80A, SERIE TK TK80MA, SERIE TK TK85, SERIE TK TK85M, SERIE TL TL70A, SERIE TL TL80A	1930537	
15147	L. 353 mm. Esterno/ L. 353 mm. Outer		SERIE 90 110.90, SERIE 90 100.90, SERIE 90 85.90, SERIE 93 88.93, SERIE 94 88.94, SERIE WINNER F100, SERIE WINNER F110, SERIE WINNER F120, SERIE WINNER F115	1930589, 47128157	
15148	Interno/Inner		SERIE 90 110.90, SERIE 90 100.90, SERIE 90 85.90, SERIE 93 88.93, SERIE 94 88.94, SERIE WINNER F100, SERIE WINNER F110, SERIE WINNER F120, SERIE WINNER F115	1930590, 47128156	
15149	Esterno/Outer		SERIE 66 35.66	1930591	
15150	Interno/Inner		SERIE 66 35.66	1930592	
15183	Esterno/Outer	FIAT	1355C, 16, 18HD/LC, 18R, 7, 7B, 9, 9 LPG, SERIE 1300	1909957, 70257024, 73067507, 73119795, 79011386, 79083212, 8014390, 87704240, 9927604	
15185	Interno/ Inner		SERIE 66 55.66/VF, SERIE 76 45.76/V, SERIE 86 70.86/V, SERIE 86 50.86/V, SERIE 86 55.86/VF, SERIE 86 60.86/VF	1930442	
15186	Esterno/Outer		SERIE 66 55.66/VF, SERIE 76 45.76/V, SERIE 86 70.86/V, SERIE 86 50.86/V, SERIE 86 55.86/VF, SERIE 86 60.86/VF	1930443	
15187	Autopulente. Interno/ Self-cleaning. Inner		SERIE 75 55.75, SERIE 75 60.75, SERIE 75 70.75, SERIE 75 80.75, SERIE 85 72.85, SERIE 85 82.85, SERIE 85 62.85	1930730, 700053475, 79062700	
15193	Esterno/Outer		SERIE 75 55.75, SERIE 75 60.75, SERIE 75 70.75, SERIE 75 80.75, SERIE 85 72.85, SERIE 85 82.85, SERIE 85 62.85	1930764, 79062702, 79072795	
15196	Filtro a bagno d'olio/ Oil bath fil er		45.66/DT, 50.66/DT, 55.56/DT, 55.88/DT, 60.56/DT, 60.93/DT, 65.56/DT, 65.93/DT, 70.56/DT, 70.88/DT, 72.93/DT, 80.66/DT, 80.88/DT, 82.93/DT	5136557, 5136558, 8323083	

Art./Ref.	Note/Note	Brand	Applicazione/Application	Rif. Orig./Orig. Ref.	Immagine/Image
17751	Esterno/Outer	FIAT	TW 10 BSD 666, TW 5 BSD 666	81866927	-
28221	L. 305mm. Interno/ L. 305mm. Inner		100.90 - 100.90 DT, 110.90 - 110.90 DT, 1180DT, 1280, 1280DT, 1380DT, 1580DT, 1880DT, 55.90 - 55.90 DT, 580, 580DT, 60.90 - 60.90 DT, 65.90 - 65.90 DT, 680, 680DT, 70.90 - 70.90 DT, 70C, 70C, 70R, 780, 780DT, 80.90 - 80.90 DT, 80CA, 80R, 85.90 - 85.90 DT, 855, 88.93 - 88.93 DT, 88.94 - 88.94 DT, 880, 880/S, 880DT, 90.90 - 90.90 DT, 905C, 955, 980, 980DT, 995C, F100 - F100 DT, F110 - F110 DT, F115 - F115 DT, F120 - F120 DT	1909117, 1930825, 71406283	
28222	Esterno/Outer		SERIE 85 88.85	1930824, 1931027, 71405431, 71467925, 87342507	
28224			SERIE 55 85.55, SERIE 55 95.55, SERIE 90 110.90, SERIE 90 100.90, SERIE 90 70.90, SERIE 90 85.90, SERIE 90 55.90, SERIE 90 60.90, SERIE 90 65.90, SERIE 90 90.90, SERIE 90 80.90	1930138, 9960540	-
28225	Esterno/Outer		88.93 - 88.93 DT, 88.94 - 88.94 DT, F100 - F100 DT, F110 - F110 DT, F115 - F115 DT, F120 - F120 DT	1930605	
12959		FORD	3435 8035.06, 3935 8035.06, 4135 8035.06	8322103	
14886	Esterno/Outer		3435 8035.06, 3935, 3935 8035.06, 4030, 4135 8035.06, 4230, 4430, 4635 8035.06, 4835 8045.06, 5635 8045.06, 6635, 7635	1930587	
14887	Interno/Inner		3435 8035.06, 3935, 3935 8035.06, 4030, 4135 8035.06, 4230, 4430, 4635 8035.06, 4835 8045.06, 5635 8045.06, 6635, 7635	1930588	
15145	Esterno/Outer		4635, 4835, 5635	1930536, 87780710	
15146	Interno/Inner		4635, 4835, 5635	1930537	
15147	L. 353 mm. Esterno/ L. 353 mm. Outer		4635, 4835, 5635, 6635, 7635	47128157	
15148	Interno/Inner		4635, 4835, 5635, 6635, 7635	1930590	

Art./Ref.	Note/Note	Brand	Applicazione/Application	Rif. Orig./Orig. Ref.	Immagine/Image
15183	Esterno/Outer	FORD	1164, 1454	5011316, 5011549	
15185	Interno/Inner		3830	1930442	
15186	Esterno/Outer		3830	1930443	
15196	Filtro a bagno d'olio/ Oil bath filter		3435, 3935, 4635, 4835, 5635	5136557, 5136558, 8323083	
17749	L. 380mm. Esterno/ L. 380mm. Outer		2310 BSD 326, 2610>01.82 BSD 329, 2810 BSD 326, 2910 BSD 329, 3230 BSD 332, 3430 BSD 332, 3610>01.82 BSD 332, 3910 BSD 332, 3930 BSD 333, 4110>01.82 BSD 333H, 4130 BSD 333, 4610>01.82 BSD 333H, 4630 BSD 333H, 4830 BSD 442, 5030 BSD 442, 5110 BSD 444, 5600 10/80< BSD 444, 5600<09/80 BSD 442, 5610 BSD 444, 5700 10/80< BSD 444, 5700<09/80 BSD 442, 6600>09.80 BSD 444, 6710>09.80 BSD 444, 8500	83908365, 86908365, D6NN-9601-B	
17750	L. 336mm. Interno/ L. 336mm. Inner		2310 BSD 326, 2610>01.82 BSD 329, 2810 BSD 326, 2910 BSD 329, 3230 BSD 332, 3430 BSD 332, 3610>01.82 BSD 332, 3910 BSD 332, 3930 BSD 333, 4110>01.82 BSD 333H, 4130 BSD 333, 4610>01.82 BSD 333H, 4630 BSD 333H, 4830 BSD 442, 5030 BSD 442, 5110 BSD 444, 5600 10/80< BSD 444, 5600<09/80 BSD 442, 5610 BSD 444, 5700 10/80< BSD 444, 5700<09/80 BSD 442, 6600>09.80 BSD 444, 6710>09.80 BSD 444	83908360, D6NN-9R-500B	-
28221	L. 305mm. Interno/ L. 305mm. Inner		6635 - 7635	1930825	
28225	Esterno/Outer		6635 - 7635	1930605	
42174	Interno/Inner		8630 BSD 666T, 9700 BSD 666T, TW 15 BSD 666T, TW 20 BSD 666T	81866982, E6NN9R500FB	-
42175			2100, 2110, 2120, 2150, 2310, 2503E, 2511E, 2513E, 3055, 3100, 3120, 3150, 3190, 3300, 3310, 3500, 3600, 4000, 4100, 4140, 4190, 420, 4200, 4400, 4410, 4610SU, 515, 531, 5320, 535, 5500, 620, 630, 640, 6610, 6710, 8630 BSD 666T, 9700 BSD 666T, DEXTRA 2000, MAJOR 16-6, MAJOR 4000, MAJOR 5000, SUPER DEXTRA 3000, TW 15 BSD 666T, TW 20 BSD 666T	81866999, D5NN9B618B, E6NN9B618BB	
42176	L.443mm Interno/L.443mm. Inner	8730 BSD 666T, 8830 BSD 666TI, TW 25 BSD 666T, TW 30 BSD 666TI, TW 35 BSD 666TI	83913764, D8NN9R500AA	-	
42177	L.475mm. Esterno/L.475mm. Outer	8730 BSD 666T, 8830 BSD 666TI, TW 25 BSD 666T, TW 30 BSD 666TI, TW 35 BSD 666TI	83913766, D8NN9B618AA	-	
42178	L. 288 mm. Interno/ L. 288 mm. Inner	5640 P.S. 4.4, 6640 P.S. 5.0, 66400 FRUTTETO, 77400 FRUTTETO, 7840 P.S. 6.6, 8160, 8240 P.S. 7.5, 8260, 8340 9/93< P.S. 7.5T, 8340<8/93 P.S. 7.5, 8360, 8560	82008601, E9NN 9R500AB		

Art./Ref.	Note/Note	Brand	Applicazione/Application	Rif. Orig./Orig. Ref.	Immagine/Image
<b>42179</b>	L. 323 mm. Esterno/ L. 323 mm. Outer	<b>FORD</b>	5610, 5640 P.S. 4.4, 6610, 6640 P.S. 5.0, 6810, 7610, 7740 P.S. 5.0T, 7840 P.S. 6.6, 8160, 8240 P.S. 7.5, 8260, 8340 9/93 < P.S. 7.5T, 8340 < 8/93 P.S. 7.5, 8360, 8560	82008600, 82027152, E9NN9B- 618BA	
<b>42200</b>	Prefilt o Ø 58mm		2000, 2310, 2600, 2610, 2810, 2910, 3600, 3610, 3900, 3910, 4100, 4110, 4610, 5110, 5600, 5610, 5700, 5900, 6600, 6700	81823388, CON- N9A660A	-
<b>02717</b>	Esterno/Outer	<b>NEW HOLLAND</b>	1048, 4030, 4230, 4430, 8066, TK 5565F, 5565F, 5565V, TK 5575F, 5575M, 5575V, TK 6065, 6065M, 6065V, TK 6075, 6075M, 6075V, TK 7065, 7065 M, TK 7075, 7075M, TK 8065, TK 8066 DT, TK 8075	1909139	
<b>02724</b>	Interno/Inner		TK 5565F, 5565M, 5565V, TK 5575F, 5575M, 5575V, TK 6065, 6065M, 6065V, TK 6075, 6075M, 6075V, TK 7065, 7065M, TK 7075, 7075M, TK 8065, TK 8066DT, TK 8075	1909138	
<b>12959</b>			4635 L60 8035.05, 4835 L65 8045.06, 5635 L75 8045.06, 6635 L85 8045.25, L60, L65, L75, TK 6065, 6065M, 6065V, TK 7065, 7065M, TK 8065, TK 8066DT, TK 8555, TL100, TL70, TL80, TL90	4987759, 8322103	
<b>14886</b>	Esterno/Outer		4635 L60 8035.05, 4835 L65 8045.06, 5635 L75 8045.06, L60, L65, L75, L85, L95, SERIE L L65, SERIE L L60, SERIE L L75, TD55D - TD60D - TD65D - TD70D, TD75D - TD80D - TD85D - TD90D, TD95D, TK5575F, TK5575M, TK5575V, TK5585F, TK5585M, TK5585V, TK6085F, TK6085M, TK65F, TK65V, TK75F, TK75M, TK75V, TK76, TK76M, TK85, TK85M, TK95M, TL70, TL80, TL90, TL100, TN55, TN65, TN70, TN75, TN55D, TN65D, TN70D, TN75D, TN55S, TN65S, TN70S, TN75S, TN55V, TN65V, TN75V, TN60A, TN70A, TN75A, TN60DA, TN70DA, TN75DA, TN60SA, TN70SA, TN75SA, TN65F, TN70F, TN75F, TN80F, TN65N, TN75N, TN90F, TN95F, TT65D	1930587, 47135972	
<b>14887</b>	Interno/Inner		4635 L60 8035.05, 4835 L65 8045.06, 5635 L75 8045.06, L60, L65, L75, L85, L95, SERIE L L65, SERIE L L60, SERIE L L75, TD55D - TD60D - TD65D - TD70D, TD75D - TD80D - TD85D - TD90D, TD95D, TK5575F, TK5575M, TK5575V, TK5585F, TK5585M, TK5585V, TK6085F, TK6085M, TK65F, TK65V, TK75F, TK75M, TK75V, TK76, TK76M, TK85, TK85M, TK95M, TL70, TL80, TL90, TL100, TN55, TN65, TN70, TN75, TN55D, TN65D, TN70D, TN75D, TN55S, TN65S, TN70S, TN75S, TN55V, TN65V, TN75V, TN60A, TN70A, TN75A, TN60DA, TN70DA, TN75DA, TN60SA, TN70SA, TN75SA, TN65F, TN70F, TN75F, TN80F, TN65N, TN75N, TN90F, TN95F, TT65D	1930588, 47135975	
<b>15145</b>	Esterno/Outer		4635 L60 8035.05, 4835 L65 8045.06, 5635 L75 8045.06, SERIE L L65, SERIE L L85, SERIE L L95, SERIE L L60, SERIE L L75, TD55D - TD60D - TD65D - TD70D, TD75D - TD80D - TD85D - TD90D, TD95D, TK60.65 - TK60.65 M, TK65F - TK65V, TK70.65 - TK70.65 M, TK70FA - TK70VA, TK75F - TK75FA, TK75M - TK75MA, TK75V - TK75VA, TK76 - TK76M, TK80.65, TK80A - TK80MA, TK85 - TK85M, TK90A - TK90MA, TK95M - TK100A, TL70 - TL80 - TL90 - TL100	1930536, 87780710	
<b>15146</b>	Interno/Inner		4635 L60 8035.05, 4835 L65 8045.06, 5635 L75 8045.06, SERIE L L65, SERIE L L60, SERIE L L75, TD55D - TD60D - TD65D - TD70D, TD75D - TD80D - TD85D - TD90D, TD95D, TK60.65 - TK60.65 M, TK65F - TK65V, TK70.65 - TK70.65 M, TK70FA - TK70VA, TK75F - TK75FA, TK75M - TK75MA, TK75V - TK75VA, TK76 - TK76M, TK80.65, TK80A - TK80MA, TK85 - TK85M, TK90A - TK90MA, TK95M - TK100A, TL70 - TL80 - TL90 - TL100	1930537	
<b>15147</b>	L. 353 mm. Esterno/ L. 353 mm. Outer		6635 L85 8045.25, 7635 L95 8045.25, L60, L65, L75, L95, SERIE L L95, SERIE L L85, SERIE TL TL100, SERIE TL TL100DT, SERIE TL TL70, SERIE TL TL70DT, SERIE TL TL75, SERIE TL TL80, SERIE TL TL90, SERIE TL TL90DT, TD55D, TD65D, TD75D, TD60D, TD70D, TD75D, TD80D, TD90D, TD95D, TD85D, TD95D, TK100-55, TL65, TL70, TL80, TL90, TL100	1930589, 47128157	



Art./Ref.	Note/Note	Brand	Applicazione/Application	Rif. Orig./Orig. Ref.	Immagine/Image
15148	Interno/Inner	NEW HOLLAND	6635 L85 8045.25, 7635 L95 8045.25, L60, L65, L75, L85, L95, SERIE L L95, SERIE L L85, SERIE LM LM1333, SERIE LM LM1440, SERIE TB TB100, SERIE TB TB110, SERIE TB TB120, SERIE TD TD60D PLUS, SERIE TD TD70D PLUS, SERIE TD TD80D PLUS, SERIE TD TD90D PLUS, SERIE TD TD95D, SERIE TD TD95D PLUS, SERIE TL TL100, SERIE TL TL100A, SERIE TL TL70A, SERIE TL TL90A, SERIE TN TN85A, SERIE TT TT55, SERIE TT TT75, TD55D, TD60D, TD65D, TD70D, TD75D, TD80D, TD85D, TD90D, TD95D, TK100-55, TL60, TL75, TL85, TL95, TL60E, TL75E, TL85E, TL95E, TL65, TL70, TL80, TL90, TL100	1930590, 47128156	
15196	Filtro a bagno d'olio/ Oil bath filter		L60, L65, L75, TK60-65, TK60-65 M, TK60-65 V, TK70-65, TK70-65 M, TK80-65, TL100, TL65, TL70, TL80, TL90	5136557, 5136558, 8323083	
28221	L. 305mm. Interno/ L. 305mm. Inner		6635 L85 8045.25, 7635 L95 8045.25, L85 - L95, SERIE L L95, SERIE L L85, SERIE TK TK100A, SERIE TK TK80A, SERIE TN TN75FA, SERIE TN TN85FA, SERIE TN TN90F, SERIE TN TN95DA, SERIE TN TN95F, SERIE TN TN95VA, TD60D - TD70D - TD75D, TD80D - TD90D - TD95D, TK100.55, TK100A, TK65F - TK65V, TK70FA - TK70VA, TK75F - TK75M - TK75V, TK75FA - TK75MA - TK75VA, TK76 - TK76M, TK80A - TK80MA, TK85 - TK85M, TK85.55 - TK95.5, TK88.85 M, TK90A - TK90MA, TK95M, TL100, TL60 - TL65 - TL70 - TL75, TL60E - TL75E - TL85E - TL95E, TL80 - TL85 - TL90 - TL95, TN65F - TN70F - TN75F, TN75FA - TN85FA - TN95FA, TN80F - TN90F - TN95F, TN95NA, TN95VA	1930825, 71406283, 87342481	
28225	Esterno/Outer		6635 L85 8045.25, 7635 L95 8045.25, L85 - L95, SERIE L L95, SERIE L L85, TD60D - TD70D - TD75D, TD80D - TD90D - TD95D, TL100, TL60 - TL65 - TL70 - TL75, TL60E - TL75E - TL85E - TL95E, TL80 - TL85 - TL90 - TL95	1930605	
42178	L. 288 mm. Interno/ L. 288 mm. Inner		M100, M115, M135, SERIE M M115, SERIE M M150, SERIE M M100, SERIE TM TM115, SERIE TS TS100, SERIE TS TS110, SERIE TS TS90, TM115, TM125, TM135, TM150, TM165, TS110, TS115, TS120, TS80, TS90, TS100	82003739, 82008601	
42179	L. 323 mm. Esterno/ L. 323 mm. Outer		M100, M115, M135, M160, SERIE M M100, SERIE M M115, SERIE M M150, SERIE TM TM115, TM115	82008600, 82027152	

**FILTRI ARIA ORIGINALI**

FILTRE AIR ORIGINAL  
AIR FILTER ORIGINAL  
LUFTFILTER ORIGINAL  
FILTROS ORIGINAL

Art./Ref.	Brand	Rif. Orig./Orig. Ref.
NH1909138	NEW HOLLAND	1909138
NH1909139		1909139
NH1930174		1930174
NH1930175		1930175
NH1930442		1930442
NH1930443		1930443
NH1930605		1930605
NH1930730		1930730, 47498744
NH1930764		1930764, 84375819
NH1930825		1930825
NH47135975		47135975, 86982523
NH5196842		5196842
NH87682993		1930589, 87682993
NH87682999		1930590, 87682999
NH87704249		47135972, 87704249



**FILTRI ARIA ADATTABILI**

FILRE AIR ADAPTABLE  
AIR FILTERS ADAPTABLE  
LUFTFILTER PASSEND ZU  
FILTROS AIRE ADAPTABLE

Art./Ref.	Note/Note	Brand	Applicazione/Application	Rif. Orig./Orig. Ref.	Immagine/Image
<b>08283</b>	Esterno/Outer	<b>DEUTZ</b>	70 >02/01, 70 >03/97, 80 >02/01, AGROCOMPAKT 60AF, AGROCOMPAKT 60F, AGROCOMPAKT 60V, AGROCOMPAKT 70AF, AGROCOMPAKT 70F, AGROCOMPAKT 70V, AGROPLUS 60, AGROPLUS 70, AGROPLUS 80, AGROPLUS 87, AGROPLUS 90	2.4249.310.4	
<b>08284</b>	Interno/Inner		70, AGROLUX 90, AGROPLUS 87, AGROTRON 80	2.4249.130.7	
<b>53216</b>	Esterno/Outer		Agrostar DX6.61, D4005, D4505, D5005, D5505, DX140, DX145, DX160, DX6.50, DX7.10, Intrac 2005, Intrac 2006, Intrac 6.30 Turbo	2165049	
<b>53215</b>	Interno/Inner		5510, 6.05 >01/88, 6.60 >01/88, Agrostar DX6.61, DX130, DX140, DX145, DX140A, DA145A, DX160, DX160A, DX160 05/78-01/86, DX6.50, DX7.10, Intrac 6.30 Turbo, Intrac 6.60, M1600 HYDROMAT, M2385, M2480, M4030, MH650, SFH 3008, 3008A	2241329	
<b>53238</b>	Esterno/Outer		3.70F/V >01/87, 3.90FA/VA/S >01/87, AgroCOMPAKT 3.90 FA/VA/S, AgroPRIMA 4.51, 4.56, 6.06, Agrostar DX6.11, DX6.21, Agroxta 4.17 (DX), Agroxta 4.47, Agroxta 6.17, Agroxta 3.57, Agroxta 4.07, Agroxta 4.57 (DX), Agroxta 6.07, Agroxta 6.17, Agroxta BF4L913, Agroxta F6L14, Agroxta F6L912, D10006, D12006, D13006, D6265, D7506, D7807, D7807A, D7807C, D8000, D8006, D9006 (A), DX110 (A), DX120 (A), DX3.57, DX3.60, DX3.65, DX3.70, DX3.80, DX3.70 V/F, DX3.80 V/F/S, DX3.90, DX3.90 F/S, DX4.07, DX4.10, DX4.17 (A), DX4.30, DX4.31, DX4.47, DX4.50, DX4.51, DX4.56, DX4.57 (A), DX4.70, DX6.05, DX6.06, DX6.07, DX6.10, DX6.16, DX6.17, DX6.30, DX80 (A), DX85 (A), DX86 (A), DX90 (A), DX92 (A)	2323855, 4384103, C17250	
<b>53239</b>	Interno/Inner		Agrostar DX6.11, D10006, D12006, D13006, D7506, D7807 (A), D8006, D9006, DX110 (A), DX120, DX6.05, DX6.07, DX6.10, DX6.30, DX85, DX86, DX90, DX92	2379163, 4308636, CF811	
<b>53975</b>	Interno/Inner		2006, Agrostar 6.38, Agrostar DX4.61, Agrostar DX6.11, Agrostar DX6.21, Agrostar DX6.88, Agroxta 4.17, Agroxta 4.47, Agroxta 6.17, Agroxta 4.07, Agroxta 6.07, Agroxta 6.17, Agroxta BF4L913, Agroxta F6L14, Agroxta F6L912, DX3.57 >10/91, DX4.07 >10/91, DX4.17 >03/90, DX4.47 >03/90, DX4.57 >03/90, DX6.07 >03/90, DX6.17 >10/91, INTRAC 2005, 2006, M1080, M750, M770, M980, M1002	2165044	
<b>53976</b>	Esterno/Outer		AgroCOMPAKT 3.30F/V, AgroCOMPAKT 3.50F/S/V, AgroCOMPAKT 3.90FA/VA/S, Agroxta 4.17, Agroxta 4.47, Agroxta 6.07, Agroxta F6L912, Agroxta 4.07, Agroxta 6.07, Agroxta 6.17, Agroxta BF4L913, Agroxta F6L13, D2506, D3006, D3607, D3607, D4007, D4507, D4807, D4006, D4206, D5506, D6006, D5207, D6207, D6507, D6907C, D6806, D7206, D7007 (C), D7207 (C), D7807A/C, D8006, DX3.10, DX3.30, DX3.50, DX3.60, DX3.10V, DX3.30V/F/S, DX3.50V/F/S, DX3.57, DX3.60, DX3.65, DX3.80, DX3.70V/F, DX3.80V/F/S, DX3.90F/S, DX36V, DX4.07, DX4.17, DX4.47, DX4.57, DX4.17 A/H, DX50, DX50V, DX55V, DX6.07, DX6.17, Intrac 2002, Intrac 2003, Intrac 2004	4384102, C17134	
<b>59846</b>	Interno/Inner		AGROSTAR, M1002, M1080, M980	2414950, 2415950, 2985037	

Art./Ref.	Note/Note	Brand	Applicazione/Application	Rif. Orig./Orig. Ref.	Immagine/Image
08283	Esterno/Outer	HURLIMANN	105XT, 307XE, 372 TURBO, 4105DT TURBO, 476, 476.4, 476F/X, 481XF, 488 TURBO, 491XF, 496, 5110, 5116 TURBO, 607XADT, 6115, 6115 T ELITE, 6136, 656XA, 656XAA/DT >01/99, 657XA >06/99, 658XA >06/99, 706XN >01/99, 707XN >01/99, 708XN >01/99, 70XS, 908XTDT, 910.4XT, 910.4XTDT, 910.6XT, 910.6XTDT, 95XT, 98XT	2.4249.310.4	
08284	Interno/Inner		6115 - 6115T, 656DT - 656XAT, H 307 XE, H 372, H 4105 DT, H 488 - H 496, H 5110 H 5116, H 6136, HA 607 DT, HA 65 - XF 481 - XF 491, HA 656 - XA 658, XN 706 - 707 - 708, XS 70, XT 105, XT 908 - XT 908 DT, XT 909 DT, XT 910.4 - XT 910.4 DT, XT 910.6 - XT 910.6 DT, XT 95	2.4249.130.7	
08283	Esterno/Outer	SAME	ANTARES 100, ARGON 70, ASTER 70, EXPLORER 70 C, EXPLORER 65 C, EXPLORER 75 C, EXPLORER 75 SPECIAL, EXPLORER 80 C, EXPLORER 90 C, EXPLORER 90 II SPECIAL, EXPLORER 90 SPECIAL, FRUTTETO 75 II, FRUTTETO 85 II, LASER 100, LASER 110, LASER 130, LASER 90, ROW CROP 90, SILVER 100.4, SILVER 100.6, SILVER 80, SILVER 90	0.009.4108.0, 2.4249.130.0, 2.4249.131.0, 2.4249.310.4	
08284	Interno/Inner		100 DT, 100.4 DT - 100.6 DT, 110 DT - 130 DT, 80 - 80 C - 80 DT, 90 - 95, ANTARES 100 - 110, BUFFALO 120 - 130, DORADO 85, DRAGO 100, EXPLORER 70 C, EXPLORER 75 - 80 - 90, EXPLORER 90 C, EXPLORER II 90 - 90 SP, JAGUAR 95 - 100, LASER 90 - 100 - 110 - 130	2.4249.130.7	
15183	Esterno/Outer		1056L, 1056P, BUFFALO 120 2RM, BUFFALO 130 4RM, BUFFALO 130 EXPORT, DRAGO 100, JAGUAR 95, JAGUAR 95 EXPORT, LASER 100, LASER 110, LASER 130, LEOPARD 90 TURBO, PANTHER 90, PANTHER 95, TIGER 100 2RM, TIGER SIX 105, TIGER SIX 105 EXPORT, TRIDENT 130 EXPORT	2.4249.130.1, 2.4249.130.8	
15185	Interno/Inner		ARGON 50, ARGON 60, ASTER 60, CENTAURO 70 EXPLORER, CENTAURO 70 SPECIAL, CENTURION 75 SPECIAL, EXPLORER 70 C, EXPLORER 55, EXPLORER 60, EXPLORER 60 SPECIAL, EXPLORER 65, EXPLORER 65 C, EXPLORER 65 SPECIAL, EXPLORER 70, EXPLORER 70 SPECIAL, EXPLORER 75 SPECIAL, EXPLORER II 60, EXPLORER II 60 SPECIAL, EXPLORER II 70, EXPLORER II 70 SPECIAL, EXPLORER II 70 SPECIAL B, FRUTTETO 60, FRUTTETO 60 II, FRUTTETO 75, MERCURY 85 SPECIAL, MINITAUROS 60 FRUTTETO, MINITAUROS 60 SYNCRO, ROW CROP 85, SOLAR 50, SOLAR 55 C, SOLAR 60, SOLAR 60 C	2.4249.340.2, 2.4249.390.2	
15186	Esterno/Outer		ARGON 50, ARGON 60, ASTER 60, CENTAURO 70 EXPLORER, CENTAURO 70 SPECIAL, CENTURION 75 SPECIAL, EXPLORER 70 C, EXPLORER 55, EXPLORER 60, EXPLORER 60 SPECIAL, EXPLORER 65, EXPLORER 65 C, EXPLORER 65 SPECIAL, EXPLORER 70, EXPLORER 70 SPECIAL, EXPLORER 75 SPECIAL, EXPLORER II 60, EXPLORER II 60 SPECIAL, EXPLORER II 70, EXPLORER II 70 SPECIAL, EXPLORER II 70 SPECIAL B, FRUTTETO 60, FRUTTETO 60 II, FRUTTETO 75, MERCURY 85 SPECIAL, MINITAUROS 60 FRUTTETO, MINITAUROS 60 SYNCRO, ROW CROP 85, SOLAR 50, SOLAR 55 C, SOLAR 60, SOLAR 60 C	2.4249.340.1	
28226	Interno/Inner	AURORA 45, CENTURION 75, DELFINO 35, DELFINO 35 FRUTTETO, LEOPARD 85, LEOPARD 85 EXPLORER, PANTHER 88, RANGER 45, RANGER 45 FRUTTETO	2.4249.060.1, 2.4249.060.8, 2.4249.500.2, 2.4249.510.1		

**FILTRI ARIA ORIGINALI**

FILTRE AIR ORIGINAL  
AIR FILTERS ORIGINAL  
LUFILTER ORIGINAL  
FILTROS AIRE ORIGINAL

Art./Ref.	Brand	Rif. Orig./Orig. Ref.
V2.4249.130.7	SAME	2.4249.130.7
V2.4249.131.0		2.4249.131.0
V2.4249.190.1		2.4249.190.1
V2.4249.340.1		2.4249.340.1
V2.4249.340.2		2.4249.340.2



**FILTRI ARIA ADATTABILI**

FILTRE AIR ADAPTABLE  
AIR FILTERS ADAPTABLE  
LUFTFILTER PASSEND ZU  
FILTRO AIRE ADAPTABLE

Art./Ref.	Note/Note	Brand	Applicazione/Application	Rif. Orig./Orig. Ref.	Immagine/Image
<b>02717</b>	Esterno/Esterno	<b>JOHN DEERE</b>	1020, 10200U/VU, 1030, 105, 111 PEANUT, 1120, 1130, 1520, 1530, 1630, 1630 UV/VU, 165, 1830, 2020, 2030, 2120, 2120 CDN, 2130, 2440, 299, 300B, 301, 301A, 302, 302A, 310, 330, 3300, 34, 400, 401, 401B, 401C, 44, 45, 482, 499, 5200, 5300, 55, 600, 600A, 6000, 6300U, 65, 700, 710, 734, 800, 820, 820VU, 830, 830M, 84, 880, 925, 930, 95, 95H	AT20728, C14179	
<b>02724</b>	Interno/Inner		6000	AN153119	
<b>15148</b>	Interno/Inner		5000, 5083E/EN, 5093E/EN, 5101E/EN, 5210, 5220, 5220H, 5225, 5303, 5310, 5310N, 5320, 5320N, 5325, 5325N, 5403, 5410, 5410N, 5415, 5415H/N, 5420, 5420N, 5425, 5425N, 5503, 5510, 5510N, 5520, 5520N, 5525, 5525N, 5603, 5605, 5615, 5625, 5625HC, 5705, 5715, 5715HC, 5725, 5725H/HC, 6403, CT332	AT171854, RT6005011112	
<b>15147</b>	L. 353 mm. Esterno/ L. 353 mm. Outer		3100, 3200(X), 3210(X), 3300(X), 3310(X), 3400(X), 3410(X)	AT171853, RT6005011111	
<b>15183</b>	Esterno/Outer		1650, JD34, JD44, JD45	CH18287, CHAM64261, TH106445	
<b>53216</b>	Esterno/Outer/		3650	AZ30757	
<b>53241</b>	Interno/Inner		6100, 6200, 6210, 6300, 6400	AL78224	
<b>53975</b>	Interno/Inner		1052, 1155, 1350, 1550, 1750, 1850, 2250, 2355, 2450, 2550, 2555, 2650, 2750, 2755, 2850, 2855N, 2950, 2955, 3050, 3055, 3155, 3255, 3350, 950, 952	AZ20623	
<b>59846</b>	Interno/Inner		1052, 1155, 1830, 1850, 3050, 3350	1052, 1155, 1850, 2250, 2355, AZ25494, AZ25498	

**FILTRI ARIA ADATTABILI**

FILTER AIR ADAPTABLE  
AIR FILTERS ADAPTABLE  
LUFTFILTER PASSEND ZU  
FILTRO AIRE ADAPTABLE

Art./Ref.	Note/Note	Brand	Applicazione/Application	Rif. Orig./ Orig. Ref.	Immagine/Image
08283	Esterno/Outer	LANDINI	10000, 10000S, 12500, 14500, 9080, 9080 HC, 9880, 9880 HC, C10500	3310355M91	
08284	Interno/Inner		14500, 9080, 9080 HC, 9880, 9880 HC	1093683M92	
14886	Esterno/Outer		5860, 6060, 6860, 6880, 7860, 7880, 8860, 8880, ADVANTAGE CAB E FOOT STEP: 85, ADVANTAGE CAB E FOOT STEP:55, ADVANTAGE CAB E FOOT STEP:60, ADVANTAGE CAB E FOOT STEP:65, ADVANTAGE CAB E FOOT STEP:75, ALPINE:65, ALPINE:75, ALPINE:85, ATLAS:70, ATLAS:75, ATLAS:80, ATLAS:85, BLIZZARD: 75, BLIZZARD:50, BLIZZARD:60, BLIZZARD:65, BLIZZARD:85, GHIBLI :80, GHIBLI NEW TIER 2: 85, GLOBUS:50, GLOBUS:55, GLOBUS:60, GLOBUS:65, GLOBUS:70, GLOBUS:75, GLOBUS:80, POWER FARM:60, POWER FARM:75, POWER FARM:85, REX CAB E FOOT STEP :60, REX CAB E FOOT STEP :70, REX CAB E FOOT STEP :80, REX NEW TIER 2:60, REX NEW TIER 2:70, REX NEW TIER 2:75, REX NEW TIER 2:80, REX NEW TIER 2:85, SERIE 60 NEW:5860, SERIE 60 NEW:6860, SERIE 60 NEW:7860, SERIE 60 NEW:8860, TREKKER :C75, TREKKER :C85, TREKKER :CF55, TREKKER :CF60, TREKKER :CF65, TREKKER :CF70, TREKKER :CF75, TREKKER :CF85, TREKKER COMPACT CF60, TREKKER COMPACT CF70, TREKKER COMPACT TIER 2:CF60, TREKKER COMPACT TIER 2:CF70, TREKKER NEW :70C/F/L, TREKKER NEW :80C/F/L, TREKKER NEW TIER 2: 75, TREKKER NEW TIER 2: 85, VISION :80, VISION NEW TIER 2:85	3540046M1	
14887	Interno/Inner		5860, 6060, 6860, 6880, 7860, 7880, 8860, 8880, ADVANTAGE CAB E FOOT STEP: 85, ADVANTAGE CAB E FOOT STEP:55, ADVANTAGE CAB E FOOT STEP:60, ADVANTAGE CAB E FOOT STEP:65, ADVANTAGE CAB E FOOT STEP:75, ALPINE:65, ALPINE:75, ALPINE:85, ATLAS:70, ATLAS:75, ATLAS:80, ATLAS:85, BLIZZARD: 75, BLIZZARD:50, BLIZZARD:60, BLIZZARD:65, BLIZZARD:85, GHIBLI :80, GHIBLI NEW TIER 2: 85, GLOBUS:50, GLOBUS:55, GLOBUS:60, GLOBUS:65, GLOBUS:70, GLOBUS:75, GLOBUS:80, POWER FARM:60, POWER FARM:75, POWER FARM:85, REX CAB E FOOT STEP :60, REX CAB E FOOT STEP :70, REX CAB E FOOT STEP :80, REX NEW TIER 2:60, REX NEW TIER 2:70, REX NEW TIER 2:75, REX NEW TIER 2:80, REX NEW TIER 2:85, SERIE 60 NEW:5860, SERIE 60 NEW:6860, SERIE 60 NEW:7860, SERIE 60 NEW:8860, TREKKER :C75, TREKKER :C85, TREKKER :CF55, TREKKER :CF60, TREKKER :CF65, TREKKER :CF70, TREKKER :CF75, TREKKER :CF85, TREKKER COMPACT CF60, TREKKER COMPACT CF70, TREKKER COMPACT TIER 2:CF60, TREKKER COMPACT TIER 2:CF70, TREKKER NEW :70C/F/L, TREKKER NEW :80C/F/L, TREKKER NEW TIER 2: 75, TREKKER NEW TIER 2: 85, VISION :80, VISION NEW TIER 2:85	3540047M1	
14888	Interno/Inner		14500, LEGEND:130, LEGEND:145, LEGEND:165	1426450M91	
14889	Esterno/Outer	LEGEND:130, LEGEND:145, LEGEND:165	3540392M91		
15147	L. 353 mm. Esterno/ L. 353 mm. Outer	6070, 9060, ADVANTAGE :L95GT, ATLAS:100, ATLAS:90, BLIZZARD:95, GHIBLI :100, GHIBLI :90, GHIBLI NEW TIER 2:105, GHIBLI NEW TIER 2:85, GHIBLI NEW TIER 2:95, LEGEND N/G:115, MYTHOS NEW TIER 2:105, MYTHOS: 110, MYTHOS:100, MYTHOS:90, POWER FARM: 105, POWER FARM: 95, REX CAB E FOOT STEP:100, REX CAB E FOOT STEP:90, REX NEW TIER 2:105, REX NEW TIER 2:95, TREKKER :C95, TREKKER NEW TIER 2: 105, TREKKER NEW TIER 2: 95, TREKKER NEW: 100C, TREKKER NEW: 90C/F/L, VISION NEW TIER 2:105, VISION NEW TIER 2:95, VISION:100, VISION:90	3540051M1		

Art./Ref.	Note/Note	Brand	Applicazione/Application	Rif. Orig./Orig. Ref.	Immagine/Image
15148	Interno/Inner	LANDINI	9060, ADVANTAGE :L95GT, ATLAS:100, ATLAS:90, BLIZZARD:95, GHIBLI :100, GHIBLI :90, GHIBLI NEW TIER 2:105, GHIBLI NEW TIER 2:95, LEGEND N/G:115, MYTHOS NEW TIER 2:105, MYTHOS NEW TIER 2:115, MYTHOS: 110, MYTHOS:100, MYTHOS:90, POWER FARM: 105, POWER FARM: 95, REX CAB E FOOT STEP:100, REX CAB E FOOT STEP:90, REX NEW TIER 2:105, REX NEW TIER 2:95, TREKKER :C95, TREKKER NEW TIER 2: 105, TREKKER NEW TIER 2: 95, TREKKER NEW: 100C, TREKKER NEW: 90C/F/L, VISION NEW TIER 2:105, VISION NEW TIER 2:95, VISION:100, VISION:90	3540052M1	
15183	Esterno/Outer		10000, 10000S, 10000S2, 10000S4, 12000, 12500, 12500 DT, 12500 DT/R, 13000, 13000 DT, 13000 MKII4, 14500, C10500	1093683M91	
15187	Autopulente. Interno/ Self-cleaning. Inner		6550, 6880, 7880, 8850, 8880, FRUTTETI 530 F/L/V:4530V, FRUTTETI 530 F/L/V:5530, FRUTTETI 530 F/L/V:6030, FRUTTETI 530 F/L/V:6530, FRUTTETI 530 F/L/V:7530, FRUTTETI 530 F/L/V:8530, FRUTTETI 560 F/L/V: 6060, FRUTTETI 560 F/L/V: 8560, FRUTTETI 560 F/L/V:5560, FRUTTETI 560 F/L/V:6560, FRUTTETI 560 F/L/V:7560, VIGNETI CAB E FOOT STEP: 65V, VIGNETI CAB E FOOT STEP: 75V, VIGNETI CAB E FOOT STEP:55V, VIGNETI CAB E FOOT STEP:60V, VIGNETI REX CAB TIER 2:75V, VIGNETI REX CAB TIER 2:85V, VIGNETI REX CAB: 80V, VIGNETI REX CAB:60V, VIGNETI REX CAB:65V, VIGNETI REX CAB:70V	3310357M1	
15190	Esterno/Outer		14500	1426451M91	-
15193	Esterno/Outer		5500, 6500, 6550, 6880, 6880 VM, 7500, 7880, 7880 VM, 8500, 8850, 8880, 8880 HC-VM, FRUTTETI 530 F/L/V:5530, FRUTTETI 530 F/L/V:6030, FRUTTETI 530 F/L/V:6530, FRUTTETI 530 F/L/V:7530, FRUTTETI 530 F/L/V:8530, FRUTTETI 560 F/L/V:4530, FRUTTETI 560 F/L/V:GE: 6060, FRUTTETI 560 F/L/V:GE: 6560, FRUTTETI 560 F/L/V: 8560, FRUTTETI 560 F/L/V:5560, FRUTTETI 560 F/L/V:7560, FRUTTETI 560 V: 4560, GHIBLI NEW TIER 2: 85, TREKKER NEW 100C, VIGNETI CAB E FOOT STEP: 65V, VIGNETI CAB E FOOT STEP: 75V, VIGNETI CAB E FOOT STEP:55V, VIGNETI CAB E FOOT STEP:60V, VIGNETI REX CAB TIER 2:75V, VIGNETI REX CAB TIER 2:85V, VIGNETI REX CAB: 80V, VIGNETI REX CAB:60V, VIGNETI REX CAB:65V, VIGNETI REX CAB:70V	3310358M1	
40686	L.267mm. Esterno/ L.267mm. Outer		6505, 7505	1807257M1	-
70541	Esterno/Outer		LEGEND: 105, LEGEND: 115	3540418M91	-
70547	Interno/Inner	LEGEND: 105, LEGEND: 115	3540419M91	-	

**FILTRI ARIA ORIGINALI**

FILTRE AIR ORIGINAL  
AIR FILTERS ORIGINAL  
LUFTFILTER ORIGINAL  
FILTROS AIRE ORIGINAL

Art./Ref.	Brand	Rif. Orig./Orig. Ref.
LN3540046M1	LANDINI	3540046M1
LN3540047M1		3540047M1
LN3540051M1		3540051M1
LN3540052M1		3540052M1



**FILTRI ARIA ADATTABILI**

FILTRE AIR ADAPTABLE  
 AIR FILTERS ADAPTABLE  
 LUFTFILTER PASSEND ZU  
 FILTROS AIRE ADAPTABLE

Art./Ref.	Note/Note	Brand	Applicazione/Application	Rif. Orig./Orig. Ref.	Immagine/Image
<b>08283</b>	Esterno/Outer	<b>MASSEY FERGUSON</b>	3050 A4.236, 3060 A4.248, 3065 A4.236, 3070 A4.236, 3075 1004.4, 3075 A4.236, 3080 A6.354.4, 3085 1006.6, 3090 A6.354.4, 3095 1006.6, 3115 1006.6, 3120 1006.6T, 3120T 1006.6T, 6110 4.41, 6120 4.41, 6130 1004.4T, 6140 1004.4T, 6150 1004.4T, 6160 1006.6, 6160 1006.6T, 6170 1006.6, 6170 1006.6T, 6180 1006.6T, 698T A4.236, 699 A6.354.4	1062501M91, 3310355M91	
<b>08284</b>	Interno/Inner		1100 A6.354.1, 1200 A6.354.1, 1250 A6.354.4, 3050 A4.236, 3060 A4.248, 3065 A4.236, 3070 A4.236, 3075 1004.4, 3075 A4.236, 3080 A6.354.4, 3085 1006.6, 3090 A6.354.4, 3095 1006.6, 3115 1006.6, 3120 1006.6T, 3120T 1006.6T, 6110 4.41, 6120 4.41, 6130 1004.4T, 6140 1004.4T, 6150 1004.4T, 6160 1006.6, 6160 1006.6T, 6170 1006.6, 6170 1006.6T, 6180 1006.6T, 698T A4.236, 699 A6.354.4	1093683M92	
<b>11277</b>	-		135 AD3.152, 230 AD3.152, 240 AD3.152, 250 AD3.152, 550 AD3.152	1886673M93, 883914M94	
<b>11280</b>	-		135 AD3.152, 230 AD3.152, 240 AD3.152, 250 AD3.152, 550 AD3.152	1886670M1	
<b>14888</b>	Interno/Inner		1134, 55C, 55C SUPER, 600C, D600C	1423747M91, 1426450M91	
<b>15147</b>	L. 353 mm. Esterno/ L. 353 mm. Outer		5425, 5435, 5445, 5455, 5460, 6445, 6455, 6460, 6470	3540051M1	
<b>15148</b>	Interno/Inner		5425, 5435, 5445, 5455, 5460, 6445, 6455, 6460, 6470	3540052M1	
<b>15183</b>	Esterno/Outer		1014, 1114, 1200, 1250, 22, 24, 300, 3306, 3366, 3366AD, 33B, 33C, 33X, 400, 400C, 400D, 400DD, 400E, 44, 44B, 450, 450ELC, 450S, 750, 80, 850, 950D, D300B, D300DD, D400C, L450, RDT10000, RDT12500, SERIE 10, SERIE 100, SERIE 1000, W450D/DLS	1093682M91, 1093906M91, 1866048M92, 258541M91, 2708733M91, 3072893M1, 3311624M91, 3621282M1, 3638563M1, 726199M1, 727121M91	
<b>40667</b>	-		265 <221523 A4.248, 275 <221523 A4.248, 285 <387021 A4.248, 290 <387021 A4.248, 590 <2/85 A4.248, 690 <2/85 A4.248	3611132M1	-

Art./Ref.	Note/Note	Brand	Applicazione/Application	Rif. Orig./Orig. Ref.	Immagine/Image
40685	Interno/Inner		133 AD3.152, 135 AD3.152, 140 AD3.152, 145 AD3.152, 148 AD3.152, 150 AD3.152, 152 AD3.152, 155 AD4.203, 158 AD4.203, 165 A4.212, 165 AD4.203, 168 A4.236, 175 A4.236, 178 A4.248, 185 A4.248, 188 A4.248, 65 AD4.203, 765 AD4.203	1887575M91	
40686	L.267mm. Esterno/ L.267mm. Outer		133 AD3.152, 135 AD3.152, 140 AD3.152, 145 AD3.152, 148 AD3.152, 150 AD3.152, 152 AD3.152, 155 AD4.203, 158 AD4.203, 165 A4.212, 165 AD4.203, 168 A4.236, 175 A4.236, 178 A4.248, 185 A4.248, 188 A4.248, 65 AD4.203, 765 AD4.203	1807257M1, 26510236, 880271M1, 880271M91	-
40694	Interno/Inner		365 A4.236, 375 A4.236, 390 A4.248, 390T AT4.236, 398 AT4.236, 399 1006.6, 399 A6.354.4	3595501M1	
40695	-		365 A4.236	3595500M1	-
40703	-		4225 1004.4, 4225 4.41, 4235 1004.4, 4235 4.41, 4240 4.41	3901463M1	-
40704	L. 359 mm. Interno/ L. 359 mm. Inner	<b>MASSEY FERGUSON</b>	4225 1004.4, 4225 4.41, 4235 1004.4, 4235 4.41, 4240 4.41, 4245 1004.4T, 4255 1004.4T, 4255 4.41, 4265 1006.6	3901465M1	-
40705	-		4225 1004.4, 4225 4.41, 4235 1004.4, 4235 4.41, 4240 4.41	3901462M1	-
40706	L. 345 mm. Esterno/ L. 345 mm. Outer		4225 1004.4, 4225 4.41, 4235 1004.4, 4235 4.41, 4240 4.41, 4245 1004.4T, 4255 1004.4T, 4255 4.41, 4265 1006.6	3901464M1	
40709	-		4260 1006.6, 4270 1006.6, 5260 1006.6	3901478M1	-
40710	-		4260 1006.6, 4270 1006.6	3901477M1	-
59833			139, 139A, 142, 142MKII	325002M1, 3252002M1	



**PREFILTRI E VASCHEE ADATTABILI**

PREFILTRE ET COUVETTE ADAPTABLE  
 PRE-CLEANER AND BOWL ADAPTABLE  
 VORFILTER UND SCHALE PASSEND ZU  
 CHARTUCHO Y CUBETA ADAPTABLE

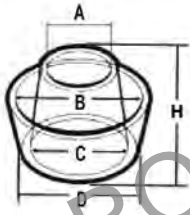

Art./Ref.	Descrizione/Description	A mm	B mm	C mm	D mm	H mm	Diametro foro mm/ Diametro foro mm	Brand	Applicazione/Application	Rif. Orig./Orig. Ref.	Immagine/Image
40712	Prefilt o/ Pre-cleaner								230 AD3.152, 240 AD3.152, 250 AD3.152, 265 A4.236, 275 A4.236, 285 A4.248, 290 A4.248, 298 A4.318, 340 AD3.152, 342 AD3.152, 350 AD3.152, 352 AT3.152, 355 AT3.152, 360 AT3.152, 362 A4.236, 372 A4.236	1687562M1	
40713	Vaschetta/ Bowl	90	160	120	154	75	65	MASSEY FERGUSON	230 AD3.152, 240 AD3.152, 250 AD3.152, 265 A4.236, 275 A4.236, 285 A4.248, 290 A4.248, 298 A4.318, 340 AD3.152, 342 AD3.152, 350 AD3.152, 352 AT3.152, 355 AT3.152, 360 AT3.152, 362 A4.236, 372 A4.236	3473919M1	
40714	Prefilt o/ Pre-cleaner								3050 A4.236, 3060 A4.248, 3065 AT4.236, 3070 AT4.236, 3080 A6.354.4, 3090 A6.354.4, 365 A4.236, 375 A4.236, 390 A4.248, 390T AT4.236, 398 AT4.236, 399 A6.354.4, 698T AT4.236, 699 A6.354.4	1693129M1	
40715	Vaschetta/ Bowl	90	180	140	170	105	80		3050 A4.236, 3060 A4.248, 3065 AT4.236, 3070 AT4.236, 3080 A6.354.4, 3090 A6.354.4, 365 A4.236, 375 A4.236, 390 A4.248, 390T AT4.236, 398 AT4.236, 399 A6.354.4, 698T AT4.236, 699 A6.354.4	1508881M1	

**FILTRI ARIA ADATTABILI ALTRI MARCHI**

FILTRE AIR ADAPTABLE AUTRES MARQUES  
 AIR FILTERS ADAPTABLE OTHER BRANDS  
 LUFTFILTER PASSEND ZU ANDERE MARKEN  
 FILTROS AIRE ADAPTABLE OTRAS MARCAS

Art./Ref.	Note/Note	Brand	Applicazione/Application	Rif. Orig./Orig. Ref.	Immagine/Image
51847	Interno/Inner		48, DOMINATOR 38	1761700, 8248360	
53215	Interno/Inner	CLAAS	202, 203, 70SF 01/75-05/84, 80SF 01/75-05/84, CC1400, COMMANDOR 112 CS, COMMANDOR 114 CS, DOMINATOR 105, DOMINATOR 106, DOMINATOR 106S, DOMINATOR 108 S/SL, DOMINATOR 108 SL MAXI, DOMINATOR 112CS, DOMINATOR 114CS, DOMINATOR 76, DOMINATOR 76H, DOMINATOR 78S, DOMINATOR 78SL, DOMINATOR 85, DOMINATOR 85H, DOMINATOR 86, DOMINATOR 88 S/SL/VX, DOMINATOR 96, DOMINATOR 98, DOMINATOR 98 S/SL/VX, DOMINATOR 98 SL MAXI, JAGUAR 60SF, JAGUAR 675, JAGUAR 680, JAGUAR 70SF, MEGA 202, MEGA 203, MEGA II 202, MEGA II 203	176168, 940084, 942084	
53975	Interno/Inner		58 48 SPECIAL, DOMINATOR 56, DOMINATOR 58S SPECIAL, DOMINATOR 66, DOMINATOR 68, DOMINATOR 68 R/S, DOMINATOR 76, DOMINATOR 76H, DOMINATOR 78S, DOMINATOR 80,85,86,96, DOMINATOR 80H, 85H, DOMINATOR 88S/SL	6766000, 6766001	

Art./Ref.	Note/Note	Brand	Applicazione/Application	Rif. Orig./Orig. Ref.	Immagine/Image
51846	Interno/Inner	FENDT	240S, 250 S/SA/V/VA, 260 S/SA/V/VA, 270 V/VA, 280 S/SA/V/VA/P/PA, 345GT, 360GT, 360GTF, 360GTH, 360GTM, CF600	F345200090010	
51847	Interno/Inner		308LSA 178/01, 308LSA FWA 178/26, 365GTA, 380GHA, 380GT, 380GTA, 380GTF, 60, CF600, CF700, FARMER 303 LS, FARMER 304 LS/LA, FARMER 305 S/LS/LSA, FARMER 306 S/LS/LSA, FARMER 307 S/LS/LSA, FARMER 308 S/LS/LSA, FARMER 309 S/LS/LSA, FARMER 310 LS/LSA	F178200090020	
51849	Esterno/Outer		240S, 250GT, 250SA, 250VA, 255GT, 275GT, 275GT/GTF/GTII, 275VA, 280PA, 345GT, 345GTM, 360GT, 360GTF, 360GTH, FARMER 240 S, FARMER 250 S/SA/V/VA, FARMER 260 S/SA/V/VA, FARMER 270 V/VA, FARMER 275 S/SA/V/VA, FARMER 280 S/SA/V/VA/P/PA, TS 80 ALLRAD	C13114/4, F100001160243, X810270073	
51850	Esterno/Outer		303 bis, 307LSA, 307, 308, 308LSA 178/01, 308LSA FWA 178/26, 309, 309LSA, 365GTA, 380GHA, 380GT, 380GTA	F178820090010	
53215	Interno/Inner		11S, 12S, 600LSA, 610LS 01/78-09/84, 610LSA, 611LS/LSA 01/76-12/93, 611LSA, 611SA/SL 01/72-12/76, 612 S/LSA 01/76-12/93, 612LSA, 612S/SA/SL 04/72-09/76, 614LS/LSA 01/76-12/93, 614LSA, 614S/SA 01/72-12/76, 614SL 01/72-12/76, 615LS/LSA 01/76-12/93, 615LSA, 615S/SL 01/72-09/76, FAVORIT 600LS, FAVORIT 610 LS/SA/SL, FAVORIT 611 LS/LSA/SA/SL, FAVORIT 612 LS/LSA/SL, FAVORIT 614 LS/LSA/SL, FAVORIT 615 LS/LSA/S/SL	F184230090100	
53216	Esterno/Outer		11S, 12S, 600LSA, 610LSA, 611LSA, 612LSA, 614LSA, 615LSA, 626LSA, 811SL	F184230090050, F291200090100	
53975	Interno/Inner		10S, 310, 310LS/LSA 01/84-08/93, 310LSA, 311, 311LAA 01/84-08/93, 311LSA, 312, 312LSA, 312LSA 01/87-08/93, 390GTA, 395GHA, 395GTA, 610S 01/72-12/76, 611S/SA 01/72-12/76, 612S/SA/SL 04/72-12/93, 614SL 01/72-12/76, FARMER 310LS/LSA, FARMER 311LSA, FARMER 312LSA, FAVORIT 610S, FAVORIT 611S/SA, FAVORIT 612S/SA/SL, FAVORIT 614S/SL/LS, FAVORIT 615S/SL/LS	F184200090010	
53976	Esterno/Outer		200 K/S/SA/V, 201S/SA, 203K/VK, 203P/PII/PA/PB/PE, 203V/VII/VA, 204P, 204P/PA/V/VA, 205P/PA/V/VA, 260P/PA/V/VA, 270P/PA/V/VA, 280P/PA, FARMER 200 K/V, FARMER 203 K/VK, FARMER 203 P/PII/PA/PB/PE, FARMER 203 V/VII/VA, FARMER 204 P/PA/V/VA, FARMER 205 P/PA/V/VA, FARMER 240, FARMER 260 P/PA/V/VA, FARMER 270 P/PA/V/VA, FARMER 280 P/PA	F135203092010	
53977	Esterno/Outer		102S, 103S, 104S, 105LSA, 105S, 106LSA, 106S, 108LSA, 108S	F278201090020	-
59833			F250GT, F255GT, F275GT, F345GT, F360GT, F360GTF, F365GT, F380GT, F380GTF, FARMER 240S, 250S, 260S, 275S, FARMER 250V, 260V, 270V, FARMER 260P, 270P, 280P	X810270073	
59847	Interno/Inner	F345GT/GTM, F360GT/GTF/GTH	F205200091010, F345200090010		

Art./Ref.	Note/Note	Brand	Applicazione/Application	Rif. Orig./Orig. Ref.	Immagine/Image
51846	Interno/Inner	RENAULT	90 S/V/VE, R 42-70 F, R 42-70 V, R 490 S	-	
51849	Esterno/Outer		42-70 F/V, 490S, 90 S/V/VE	-	
53215	Interno/Inner		113.14TS/TX, 145.14TX, R1451-4 (S)	-	
53975	Interno/Inner		70 (X), 70.12 SP, 70.14 SP, 75 (X), 85.12 LS, 851, 851-4, 95.12 TX, 95.14 TX, R 421 M, R 551 (S), R 651-4, R 851-4 (S)	-	
59833	-		490S, 90 S/V/CONE	3563577	
59839	Esterno/Outer		133 14TX, 145 14TX, 1451-4 (S), 113 14TX, 133 14TS	5000241796	
59846	Interno/Inner		70.12SP, 70.14SP, 85.12LS, 80.12TX, 80.14TX, 1451-4, 85.12LS, 85.14LS, 95.12TX, 95.14TX, CERES 85, 85X, 95, 95XMWM, 95X	7701019018	
59847	Interno/Inner		42-70F/V, 490S, 90S/V/VE, 50S/SV, 490, 44-70F, 90S VIGNE, 90S VERGER, 90S FRUITIER	7701025065	
02724	Interno/Inner	STEVR	CTV 130, CTV 150, CTV 170, CTV 120	C1281	
08284	Interno/Inner		CTV 130, CTV 150, CTV 170, CTV 120	-	
51846	Interno/Inner		7070, 8055A, 8055S, 8060, 8070A, 942 WD308.48, 308., 948 WD308.48, 308.	31100190019	
51847	Interno/Inner		M975 WD301, 8065 Turbo, 8075, 8080 Turbo, 8090, 946A WD301, 955A WD301, 970A WD301, M968A WD301	41185190007	

Art./Ref.	Note/Note	Brand	Applicazione/Application	Rif. Orig./Orig. Ref.	Immagine/Image
51849	Esterno/Outer	STEYR	7070, 8055A, 8055S, 8060, 8070A, 942 WD308.48, 308., 948 WD308.48, 308.	71201190021	
51850	Esterno/Outer		M975 WD301, 8065 Turbo, 8075, 8080 Turbo, 8090, 946A WD301, 955A WD301, 970A WD301, M968A WD301	41185190010	
53215	Interno/Inner		8130 Turbo, 8140, 8150, 8160 WD612.85, 612.89, 8160A WD612.85, 612, 8170A WD612.85, 612, 8180 Turbo WD612.89, 9105A, 9115, 9115A, 9125, 9125A, 9145A	61200190033	
53216	Esterno/Outer		1090A, 1100, 1400, 8130 Turbo, 8140, 8150, 8160 WD612.85, 612.89, 8160A WD612.85, 612, 8170A WD612.85, 612, 8180 Turbo WD612.89, 9105A, 9115A, 9125A, 9145A	61200190038, 61200190701, C20325	
53975	Interno/Inner		9084 WD401, 1200 WD612.40, 692, 792, 8100, 8100A, 8110, 8120, 8120A, 8130, 8130A, 8140, 8140A, 9078A WD401, 9083, 9083A WD401, 9086 WD401, 9086A WD401, 9094A WD401	61200190027	

**TABELLA COMPARAZIONI FILTRI ARIA PER CODICE AMA - ARTICOLI ADATTABILI ALLE SEGUENTI MARCHE**

TABLEAU COMPARAISONS FILTRES AIR PAR CODE AMA  
 TABLE OF AIR FILTERS COMPARISONS PER AMA CODE  
 LUFTFILTER VERGLEICHSTABELLE NACH AMA-CODE  
 TABLA COMPARACIONES FILTRO AIRE PARA CODIGO AMA

Riferimento AMA	OEM	Riferimento FIAAM	Riferimento Tecnicar	Riferimento M+H	Riferimento Donaldson	UFI	Note
02717	1909139	FLI6489	A592	C14179	P18-1052	2792000	FRAM (CAK253), CARRARO, GOLDONI (6340316), KUBOTA (1500037101)
02724	1909138	FLI6612	A513	CF75/1	P12-3160	2701600	FRAM (CA2557SY)
08283	1930765	FLI6620	A581	C16340	P77-2550	-	-
08284	1093683M92	FLI6418	A582	CF922	P11-9410	2794900	PERKINS (26510228)
10486	1930174	FLI6794	-	-	P77-1527	2709400	FRAM (CA1544SY)
10487	1930175	-	-	-	P12-3828	-	-
10493	4963663	-	-	-	-	-	-
11277	883914M94	-	-	-	-	-	-
11280	1886670M1	-	-	-	-	-	-
12959	8322103	-	-	-	-	-	-
14886	1930587	FLI6905	A783	C14210/2	P77-2579	2742900	-
14887	1930588	-	-	-	P77-5300	2743000	-
15021	1909114	-	-	-	-	2775300	-
15022	1909111	FLI6834	A502	-	-	2775400	-
15145	1930536	-	-	-	P77-2565	-	-
15146	1930537	-	-	-	P77-0207	-	-
15147	1930589	FLI6926	A920	C17337	P77-2580	-	-
15148	1930590	FLI6927	-	CF990/2	P82-9333	-	-
15149	1930591	FLI6929	-	C11103	P77-2578	-	-
15150	1930592	-	-	CF620	P77-5298	-	-
15183	1909957	FLI6435	A580	C16302	P18-1059	2793200	-

Riferimento AMA	OEM	Riferimento FIAAM	Riferimento Tecnicar	Riferimento M+H	Riferimento Donaldson	UFI	Note
15185	1930442	FLI6662	-	-	P77-0398	-	-
15186	1930443	FLI6663	-	-	P77-0397	-	-
15187	1930730	FLI6894	A589	-	P77-0181	-	-
15190	1930794	FLI6423	A732	C21431	P77-2545	-	-
15193	1930764	FLI6893	A583	-	P77-1549	-	-
17749	83908365	-	-	-	P52-6505	-	BALDWIN PA2587
17750	83908360	-	-	-	P52-6504	-	-
28221	1930825	-	-	-	P77-5457	-	FLEETGUARD AF25978
28222	1930824	-	-	-	P77-2553	-	BALDWIN PA3852FN
28224	1930138	FLI6858	-	-	P77-2535	-	-
28225	1930605	-	-	-	P77-8702	-	FLEETGUARD AF25342
28226	1169024	FLI6412	A572	C14190	P11-9135	2796900	DONALDSON EAF5215
40667	3611132M1	-	-	-	-	-	-
40685	1887575M91	FLI6410	A568	-	P12-0949	-	-
40686	1807257M1	FLI6200	A584	C12114	P13-6390	2776400	-
40694	3595501M1	-	A578, A581	CF961	P77-0735	-	-
40703	3901463M1	-	-	CF200	P78-0024	-	-
40704	3901465M1	-	-	CF300	P78-0030	-	LINDNER (CF300)
40705	3901462M1	-	-	CF14200	P77-8984	-	LINDNER (C14200)
40706	3901464M1	-	-	C15300	P77-8989	-	LINDNER (C15300)
40709	3901478M1	-	-	CF500	P78-0036	2750700	-
40710	3901477M1	-	-	C20500	P77-8994	2750600	-
40712	1687562M1	-	-	-	-	H001251	-
40713	3473919M1	-	-	-	-	-	-
40714	1693129M1	-	-	-	H001249	-	-
40715	1508881M1	-	-	-	P020227	-	-
42174	81866982	-	-	-	P52-6407	-	-
42175	E6NN9B618BB	-	-	-	P60-7357	-	-
42176	83913764	-	-	-	P12-4046	-	-
42177	83913766	-	-	-	P18-2070	-	-
42178	82008601	-	-	-	P60-7343	-	-
42179	82027152, 82011402"	-	-	-	P78-8888, P60-7351	-	-
42200	81823388	-	-	-	H001250	-	-
51846	3148080R1	FLI6866	-	CF600	P77-7523	-	-
51847	3147878R1	FLI6799	-	CF700	P77-7524	-	-
51849	3142497R1	-	A727	-	P11-4637	-	-
51850	3146576R1	FLI6459	A494	C15260	P18-1089	2782800	-
53215	AZ30758	FLI6801	A493	CF1000	P77-6695	-	VALMET, ZETOR
53216	AZ30757	FLI6416	A542	C20325/2	P77-1561	-	-
53238	4384103	FLI6438	A524	C17250	P77-1557	2797300	-
53239	4308636	FLI6863	-	CF811	P77-8131	-	-
53241	AL78224	-	-	C1342	P78-3501	-	-
53975	AZ20623	FLI6417	A590	C17225/3	P18-1088	2780400	VALMET
53976	4384102	FLI6304	-	C17160, C17134	P77-1594	2783700	-
53977	F278201090020	FLI6627	A492	C17201	P77-1593	-	-
59833	3563577	FLI6458	A560	C13114/4	P14-0131	2788100	-
59839	5000241796	FLI6416	A542	C20325/2	P77-1561	2780200	VALMET, ZETOR
59846	7701019018	FLI6800	A491	CF800	P77-6694	2705500	VALMET
59847	7701025065	FLI6866	-	CF600	P77-7523	2798200	-
70541	3540418M91	-	-	-	-	-	FBN AT2.01856
70547	3540419M91	-	-	-	-	-	FBN AT1.01834

AGROSAL

AGROSAL d.o.o.

AGROSAL

AGROSAL d.o.o.

d.o.o.

AG

AGROSAL d.o.o.

OSAL d.o.o.

AGROSAL d.o.o.

# 1.7.5 Filtri Cabine

Cabin Filter



**ama**

**Ricambi & accessori per macchine agricole**  
SPARE PARTS & ACCESSORIES FOR AGRICULTURAL MACHINE

Tutti gli articoli della presente sezione, prodotti da AMA SPA e/o da terzi per conto di AMA, sono adattabili ("non originali") alle marche indicate ai sensi di quanto previsto dal REG. CE n. 1400/2002. I diritti sui marchi citati appartengono ai legittimi proprietari e il loro uso ha l'esclusiva finalità di consentire all'utilizzatore la comparazione dei diversi prodotti.  
All items of this section, manufactured by AMA SPA and/or any third party on behalf of AMA, are adaptable ("non-original") to the brands listed under the provisions of the REG. CE n. 1400/2002. The rights on the trademarks belong to their respective owners and their usage is only aimed to allow the user to compare different products.

**FILTRI ARIA A PANNELLO ADATTABILI**

FILTRES A AIR A PANNEAUX ADAPTABLE

PANEL'S AIR FILTERS ADAPTABLE

PLATTENLUFTFILTER PASSEND ZU

FILTRO AIRE A PANEL ADAPTABLE

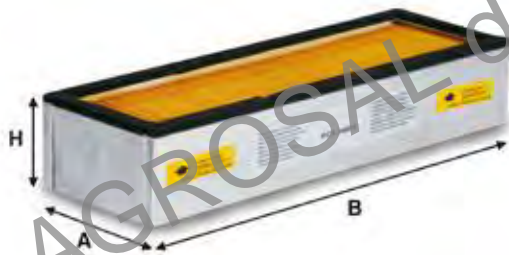

Art./Ref.	A mm	B mm	H mm	note/note	Brand	Applicazione/Application	Rif. Orig./Orig. Ref.
<b>08603</b>	100	320	56	Adattabile panclean ap3330//Adaptable panclean ap3330	<b>BRIEDA</b>	-	1AC1333
<b>08609</b>	130	400	61	Adattabile panclean ap3294/Adaptable panclean ap3294		-	1AC1304
<b>08623</b>	125	585	61	Adattabile panclean ap4424/Adaptable panclean ap4424		-	1AC1355
<b>08624</b>	180	585	60	Adattabile panclean ap3316/Adaptable panclean ap3316		-	1AC2305
<b>08625</b>	100	590	61	Adattabile panclean ap4497/Adaptable panclea ap4497		-	1AC1329
<b>08629</b>	130	680	56	Adattabile panclean ap5460/Adaptable panclean ap5460		-	1AC1306
<b>08609</b>	130	400	61	Adattabile panclean ap3294/Adaptable panclean ap3294	<b>CARRARO</b>	10400, 5400, 8400, 9400	45305574
<b>08610</b>	355	400	61	Adattabile panclean ap5272/Adaptable panclean ap5272		-	45305768
<b>08623</b>	125	585	61	Adattabile panclean ap4424/Adaptable panclean ap4424		TIGERTRAC 7700 TURBO	-
<b>08625</b>	100	590	61	Adattabile panclean ap4497/Adaptable panclea ap4497		7700 SUPERTIGRE, 7700 SUPERTRAC	45305049, 48013048
<b>08625</b>	100	590	61	Adattabile panclean ap4497/Adaptable panclea ap4497	<b>CASE</b>	2120,2130,2140,2150	401894A1, 450299A1
<b>08633</b>	190	711	56	Adattabile panclean ap3272/Adaptable panclean ap3272		1060, 1075, 1160	1105394C1, 7021959, 926389C1, D2NN19N551A, D3NN19N551A, D5NN19N551A, E2NN19N551AA
<b>08624</b>	180	585	60	Adattabile panclean ap3316/Adaptable panclean ap3316	<b>CLAAS</b>	NECTIS 227 F/VE/VL, NECTIS 237 VE/VL, NECTIS 257 F/VL, NECTIS 267 F/VL	-
<b>08610</b>	355	400	61	Adattabile panclean ap5272/Adaptable panclean ap5272	<b>FIAT</b>	-	79045228
<b>08612</b>	136	434	60	Adattabile panclean kp7736/Adaptable panclean kp7736		-	5136393
<b>08615</b>	152	435	56	Adattabile panclean ap4594/Adaptable panclean ap4594		1580, 1880	1930782, 5108728, 5109236
<b>08617</b>	147	457	59	Adattabile panclean kp7740/Adaptable panclean kp7740		65.90, F100, F100 DT, F110 DT, F115 DT, F120 DT, F130, F140	5124932, 5160985
<b>08619</b>	125	465	56	Adattabile panclean ap4420/Adaptable panclean ap4420		-	9960862
<b>08624</b>	180	585	60	Adattabile panclean ap3316/Adaptable panclean ap3316		-	79079546
<b>08633</b>	190	711	56	Adattabile panclean ap3272/Adaptable panclean ap3272		-	7021959, 70569300, 77021959
<b>14980</b>	178	435	60	Adattabile panclean ap4594g/Adaptable panclean ap4594g		-	160.90, 180.90
<b>08633</b>	190	711	56	Adattabile panclean ap3272/Adaptable panclean ap3272	<b>FORD</b>	6500, 6600, 6700, 6710, 7000, 8000, 8200, 8260, 8400, 9000, 9200, 9260, 9700	-



Art./Ref.	A mm	B mm	H mm	note/note	Brand	Applicazione/Application	Rif. Orig./Orig. Ref.
<b>08625</b>	100	590	61	Adattabile panclean ap4497/Adaptable pancea ap4497	<b>KUBOTA</b>	M128XDT, M128XDT-C, ST 30	-
<b>08633</b>	190	711	56	Adattabile panclean ap3272/Adaptable pancea ap3272		-	7009001653
<b>08624</b>	180	585	60	Adattabile panclean ap3316/Adaptable pancea ap3316	<b>JOHN DEERE</b>	5210, 5310, 5410, 5510	ER047210
<b>08633</b>	190	711	56	Adattabile panclean ap3272/Adaptable pancea ap3272		1020 > 201000, 2350, 2355, 2550, 2750, 2755, 2950, 2955, 3020, 3055, 3150, 3155, 3255, 4000, 4030, 4040, 3830, 482, 482 S/N > 237162, 4050, 4055, 4230, 4240, 4250, 4255, 4320, 4440, 4450, 4455, 4520, 4560, 4620, 4630, 4650, 4755, 4760, 4840, 4850, 4960, 484, 7740, 7745, 9900, 5020, 6030, 7020, 7520, 8430, 6000, 6500, 5730, 5820, 5830, 6622, 7722, 9900 COTTON PICKER, 8440, 8450, 8630, 8640, 8650, 8850, 9910, 9920, 9930, 9940, 9950, 9960, 9965	AN112705, RE11793
<b>08629</b>	130	680	56	Adattabile panclean ap5460/Adaptable pancea ap5460	<b>LANDINI</b>	-	3540200M1
<b>08631</b>	160	720	56	Adattabile panclean ap3273/Adaptable pancea ap3273		-	3301748M91
<b>08624</b>	180	585	60	Adattabile panclean ap3316/Adaptable pancea ap3316		10000(DA U50001), 13000 (DA U50001), 6580, 6650, 6880, 8850, 8880, 9080, 9880, ADVANTAGE 95GT, ADVANTAGE:55, ADVANTAGE:60, ADVANTAGE:65, ADVANTAGE:75, ADVANTAGE:85, ADVANTAGE:95, F/V ADVANTAGE 75, REX 60, REX 65, REX 70, REX 80, REX 90, REX VIGNETO 60, REX VIGNETO 65, REX VIGNETO 70, REX VIGNETO 80, VIGNETI CAB:55V, VIGNETI CAB:60V, VIGNETI CAB:65V, VIGNETI CAB:75V	3302666M92
<b>08629</b>	130	680	56	Adattabile panclean ap5460/Adaptable pancea ap5460	<b>LAVERDA</b>	296 LCS, 3600, 3600R, 3850, 3890	300135837, 322820100
<b>08634</b>	125	740	60	Adattabile panclean ap6089/Adaptable pancea ap6089		521, L521, L521 MCS, L624 MCS, L627	321750750
<b>08610</b>	355	400	61	Adattabile panclean ap5272/Adaptable pancea ap5272	<b>LOCHMANN</b>	624014035	-
<b>08623</b>	125	585	61	Adattabile panclean ap4424/Adaptable pancea ap4424		624015812	-
<b>08624</b>	180	585	60	Adattabile panclean ap3316/Adaptable pancea ap3316		624015818	-
<b>08624</b>	180	585	60	Adattabile panclean ap3316/Adaptable pancea ap3316	<b>MASSEY FERGUSON</b>	354, 364, 374, 675, 690, 36RS	3302666M91, 3302666M92
<b>08629</b>	130	680	56	Adattabile panclean ap5460/Adaptable pancea ap5460		7270 BETA, 7270 AL BETA	-
<b>08631</b>	160	720	56	Adattabile panclean ap3273/Adaptable pancea ap3273		-	3301748M91
<b>08633</b>	190	711	56	Adattabile panclean ap3272/Adaptable pancea ap3272		560	-
<b>08624</b>	180	585	60	Adattabile panclean ap3316/Adaptable pancea ap3316	<b>MC CORMICK</b>	F60, F70, F75, F80, F85F/GE/XL, F90, F95, F100, F105, V60, V65, V70, V75, V80, V85	-
<b>08633</b>	190	711	56	Adattabile panclean ap3272/Adaptable pancea ap3272		-	F84818

Art./Ref.	A mm	B mm	H mm	note/note	Brand	Applicazione/Application	Rif. Orig./Orig. Ref.
<b>08617</b>	147	457	59	Adattabile panclean kp7740/Adaptable panclean kp7740	<b>NEW HOLLAND</b>	F100, F100DT, F110, F110DT, F115, F115DT, F120, F120DT, F130, F130DT, F140, F140DT	84268729
<b>08633</b>	190	711	56	Adattabile panclean ap3272/Adaptable panclean ap3272		1075, 1495, 1500, 1900, 1400, 1500, 990, TR70, TR75, TR85, TR86, TR96	-
<b>08634</b>	125	740	60	Adattabile panclean ap6089/Adaptable panclean ap6089		SB 35/55, SB 36, SB 36 TIER2, SB54, SB 56, SB 56 TIER2, SB 58, SB 58 TIER2, SB 60, SB 60 TIER2, SB 62, SB 62 TIER2, SB 64, SB 64 TIER2, SB 65, SB 65 TIER2	321750750
<b>08624</b>	180	585	60	Adattabile panclean ap3316/Adaptable panclean ap3316	<b>RENAULT</b>	55-12 LB/V/F, 55-14 LB/V, 70-14 LB/V/F, 80-12 F, 80-14 LB/V/F, DIONIS 110, DIONIS 120, DIONIS 130, DIONIS 140, FRUCTUS 110, FRUCTUS 130, FRUCTUS 140, PALES 210, PALES 230, PALES 240	6005012555
<b>08625</b>	100	590	61	Adattabile panclean ap4497/Adaptable panclea ap4497		RB 140	-
<b>08625</b>	100	590	61	Adattabile panclean ap4497/Adaptable panclea ap4497	<b>SAME</b>	-	9244.330.3/10
<b>08629</b>	130	680	56	Adattabile panclean ap5460/Adaptable panclean ap5460		EXPLORER 55, EXPLORER 60, EXPLORER 60DT, EXPLORER 60F, EXPLORER 65, EXPLORER 70, EXPLORER 75 EXPORT, EXPLORER 85 EXPORT, EXPLORER ERGOMATIC, EXPLORER ERGOMATIC 75, EXPLORER ERGOMATIC 80, EXPLORER II TOP, GALAXY 170, LASER 130, LASER 150, LASER 150 TURBO, LASER 90, LASER 100, LASER 110	9244.330.2, 9244.330.3
<b>08634</b>	125	740	60	Adattabile panclean ap6089/Adaptable panclean ap6089		-	98706.512/01
<b>08616</b>	300	435	55	-	-	-	-
<b>08620</b>	145	495	55	-	-	-	-
<b>08621</b>	140	500	56	Adattabile panclean ap4463//Adaptable panclean ap4463	-	-	-

**FILTRI A CARBONI ATTIVI ADATTABILI**

FILTRES CHARBON ACTIF ADAPTABLE  
ACTIVE CARBON FULTER ADAPTABLE  
AKTIVKOHLENFILTER PASSEND ZU  
FILTRO CARBON ACTIVO ADAPTABLE

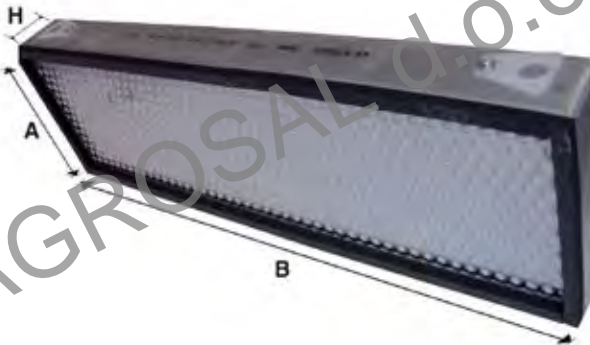

Art./Ref.	A mm	B mm	H mm	Note/Note	Brand	Applicazione/Application	Rif. Orig./Orig. Ref.
<b>61322</b>	180	585	60	Adattabile panclean ax6254 carboni attivi/ Adaptable panclean ax6254 active carbon	<b>BRIEDA</b>	-	1AC2302
<b>75321</b>	230	700	61	Adattabile panclean ax5942 carboni attivi/ Adaptable panclean ax5942 active carbon		-	1AC1324
<b>61320</b>	70	650	60	Adattabile panclean ax8256 carboni attivi/ Adaptable panclean ax8256 active carbon	<b>FIAT</b>	-	44911740, 47137324
<b>75321</b>	230	700	61	Adattabile panclean ax5942 carboni attivi/ Adaptable panclean ax5942 active carbon		-	5164680
<b>75322</b>	158	700	61	Adattabile panclean ax7909 carboni attivi / Adaptable panclean ax7909 active carbon		-	5176033
<b>75323</b>	104	520	49	Adattabile panclean ax7016 carboni attivi/ Adaptable panclean ax7016		-	5097838
<b>75391</b>	213	292	55	Adattabile panclean axh1021 carboni attivi/ Adaptable panclean axh1021 active carbon	<b>FENDT</b>	-	H117.811.130.100, H210.812.140.200
<b>61322</b>	180	585	60	Adattabile panclean ax6254 carboni attivi/ Adaptable panclean ax6254 active carbon	<b>JOHN DEERE</b>	5000,5210,5310,5410,5510,	ER047209
<b>61322</b>	180	585	60	Adattabile panclean ax6254 carboni attivi/ Adaptable panclean ax6254 active carbon	<b>LANDINI</b>	10000(DA U50001), 13000 (DA U50001), 6880, 7880, 8880, 9080, 9880, ADVANTAGE:55, ADVANTA- GE:60, ADVANTAGE:65, ADVANTAGE:75, ADVANTA- GE:85, ADVANTAGE:95, BLIZZARD:50, BLIZZARD:60, BLIZZARD:65, BLIZZARD:75, BLIZZARD:85, BLIZ- ZARD:95, FRUTTETI 560:5560, FRUTTETI 560:6060, FRUTTETI 560:6560, FRUTTETI 560:7560, FRUTTETI 560:8560, VIGNETI CAB:55V, VIGNETI CAB:60V, VIGNETI CAB:65V, VIGNETI CAB:75V	3311741M91
<b>75329</b>	95	570	55	Adattabile panclean ax8855 carboni attivi/ Adaptable panclean ax8855 active carbon		ALPINE, LANDPOWER, POWERFARM, POWERMASTER	3678352M91
<b>75393</b>	150	450	78	Adattabile panclean ax8595 carboni attivi/ Adaptable panclean ax8595 active carbon		GHIBLI NEW TIER 2:105, GHIBLI NEW TIER 2:85, GHIBLI NEW TIER 2:95, GHIBLI:100, GHIBLI:80, GHIBLI:90, LEGEND N/G-TDI:125-135-145-165, LE- GEND N/G:115, LEGEND N/G:120, LEGEND N/G:130, LEGEND N/G:140, LEGEND N/G:160, LEGEND N/G:180, MYTHOS NEW TIER 2:105, MYTHOS:100, MYTHOS:110, MYTHOS:90, VISION NEW TIER 2:105, VISION NEW TIER 2:85, VISION NEW TIER 2:95, VISION:100, VISION:80, VISION:90	3651506M92
<b>75394</b>	170	435	60	Adattabile panclean ax9446 carboni attivi/ panclean Adaptable ax9446 active carbon		GLOBUS:50, GLOBUS:60, GLOBUS:70, LEGEND: FINO A K08305 105, LEGEND: FINO A K08305 115, LE- GEND: FINO A K08305 130, LEGEND: FINO A K08305 145, LEGEND: FINO A K08305 165	3556390M92
<b>61322</b>	180	585	60	Adattabile panclean ax6254 carboni attivi/ Adaptable panclean ax6254 active carbon	<b>MC CORMICK</b>	F100, F105, F160, F70, F75, F80, F85, F90, F95, V60, V65, V70, V75, V80, V85	-
<b>75329</b>	95	570	55	Adattabile panclean ax8855 carboni attivi/ Adaptable panclean ax8855 active carbon		105, 115, 125, 125 T3, 130, 135, T3, 145, 145 T3, 160, 180, 185, 60A	-

Art./Ref.	A mm	B mm	H mm	note/note	Brand	Applicazione/Application	Rif. Orig./Orig. Ref.
75393	150	450	78	Adattabile panclean ax8595 carboni attivi/ Adaptable panclean ax8595 active carbon	<b>MC CORMICK</b>	GM45, GM50, GM55, GX40	-
61321	80	647	44	Adattabile panclean ax6205 carboni attivi/ Adaptable panclean ax6205 active carbon	<b>MASSEY FERGUSON</b>	-	3614022M91, 3614022M92
61322	180	585	60	Adattabile panclean ax6254 carboni attivi/ Adaptable panclean ax6254 active carbon		354,36RS, 364,374	3311741M91, 3405118M1
61320	70	650	60	Adattabile panclean ax8256 carboni attivi/ Adaptable panclean ax8256 active carbon	<b>NEW HOLLAND</b>	SERIE TN 55D,55S,55V,65D,65N, SE- RIE TN 65S,65V,70D,70F,70S, SERIE TN 75D,75F,75N,75S,75V, SERIE TN 80F,90F,95F	44911740, 47137324
61323	108	655	75	Adattabile panclean ax9642 carboni attivi/ panclean Adaptable ax9642 active carbon		TK4040, TK4050, TK4050M, TK4060, TN60VA, TN70NA, TN70VA, TN75NA,, TN75VA, TN85FA, TN95FA, TN95NA,	47135044
75323	104	520	49	Adaptable panclean ax7016/ Adaptable panclean ax7016 active carbon		7635 7740 7840 TL80 TS80 8160, 8260 8340 8360 8560 8770, T5050, T5060, T5070, TD55D TL65, TD65D, TL75, T SL, DT 90, TM135, 150, 165, TD5040, T5050, TS100, TL-A, TL TS110, TM115, 120	5097838
61322	180	585	60	Adattabile panclean ax6254 carboni attivi/ Adaptable panclean ax6254 active carbon	<b>RENAULT</b>	50-12LB/V, 55-12LB/V/F, 55-14LB/V, 70- 12V/F, 70-14LB/V/F, 80-12F, 80-14, DIO- NIS110, 120, 130, 140, FRUCTUS110, 120, 130, 140,, PALES210	6000166226, 6005012634, 6005711904
72555	137	760	74	Adattabile panclean ax7228 carboni attivi/ panclean Adaptable ax7228 active carbon	<b>SAME LAMBOR- GHINI HURLI- MANN</b>	EXPLORER 75,80,85,85EXPORT,90, FRUTTE- TO 60 II,75 II,85 II, HURLIMAN, HURLIMAN XA606,607,655,656, SAME DORADO56,66,86,	0.009.9423.2
75324	150	670	73	Adattabile panclean ax6592 carboni attivi/ Adaptable panclean ax6592 active carbon		SAME DORADO55F, GOLDEN60, 60F/V, SAME DORADO75V, 90F, 90S, 90V, SAME GOLDEN65, DORADO70F, S, V, 75, SAME GOLDEN85	0.010.9535.2
75325	125	740	60	Adattabile panclean ax6872 carboni attivi / panclean Adaptable ax6872 active carbon		-	0.009.4303.0
75326	120	520	73	Adattabile panclean ax9294 filt o carboni attivi / Adaptable panclean ax9294 active carbon fil er		-	0.012.0314.2
75327	105	617	53	Adattabile panclean ax7625 carboni attivi/ panclean Adaptable ax7625 active carbon		-	0.012.3260.2/30 0.130.3242/20
75392	115	395	57	Adattabile panclean ax8732 carboni attivi/ Adaptable panclean ax8732 active carbon	<b>FENDT</b>	H816.810.140.070	-

# 1.7.6 Filtri piccoli motori

Little engine filters



**ama**

**Ricambi & accessori per macchine agricole**

**SPARE PARTS & ACCESSORIES FOR AGRICULTURAL MACHINE**

Tutti gli articoli della presente sezione, prodotti da AMA SPA e/o da terzi per conto di AMA, sono adattabili ("non originali") alle marche indicate ai sensi di quanto previsto dal REG. CE n. 1400/2002. I diritti sui marchi citati appartengono ai legittimi proprietari e il loro uso ha l'esclusiva finalità di consentire all'utilizzatore la comparazione dei diversi prodotti. All items of this section, manufactured by AMA SPA and/or any third party on behalf of AMA, are adaptable ("non-original") to the brands listed under the provisions of the REG. CE n. 1400/2002. The rights on the trademarks belong to their respective owners and their usage is only aimed to allow the user to compare different products.

**FILTRO PICCOLI MOTORI ADATTABILE**
*PETITS MOTEURS FILTRES ADAPTABLE*
*SMALL ENGINES FILTERS ADAPTABLE*
*KLEINMOTOREN-FILTER PASSEND ZU*
*FILTROS DE MOTORES PEQUEÑOS ADAPTABLE*

Art./Ref.	Note/Note	Brand	Applicazione/Application	Rif. Orig./Orig. Ref.	Immagine/Image
03912	Nafta con piastra/ Fuel with plate	ACME	ACME	391.012	
32011	Aria/Air		A 180, A220, A220 B	359129300	
01213	Nafta/Fuel	CARRARO	CARRARINO SUPER 7LD 665	-	
01213	Nafta/Fuel	GOLDONI	BASE 20 121D 475/2, SERIE 933 RS/DT LDA 914	-	
02058	Nafta /Fuel		COMPACT 614 - 602 - 604 - C 45, SERIE 993 RS/DT	-	
02722	Filtro a secco/Filter		926, 926 RS/DT.	-	
02734	Olio Avvitabile//Oil Screw-on		GOLDEN IDRO 1800 - 2000, SERIE 933 RS/DT	-	
02746	Olio Avvitabile/Oil Screw-on		COMPACT 614 - 602 - 604 - C45, TRANSCAR 55 - 60 MOTORE VM, TRATTRICE 1055	-	
32143	Olio/Oil		UNIVERSAL 236 SLANZI DVA 1550	-	
37104	Nafta/Fuel	KOMATSU	15521, 43160, 55650, YM129100	-	

Art./Ref.	Note/Note	Brand	Applicazione/Application	Rif. Orig./Orig. Ref.	Immagine/Image
37099	Olio/Oil	KUBOTA	HH150 - 32430	15853-99170	
37100	Nafta/Fuel		L175, L185, L225, L245DT, L285 V1500A, L345 V1501DA	15221-43080, 15221-43170	
37101	Nafta/Fuel		-	10450-055710	
37103	Nafta/Fuel		B5100 Z5001A, B5200, B6100 D650A, B6200 D850-LA, B7100 D750A, B7100HST D750AH, B7200 D950-LA, B8200 D950A, B8200HST D950A	15231-43560, 15231-43563	
37104	Nafta/Fuel		-	15521-43160, 15567-8746-1	
37105	Nafta/Fuel		-	16271-43560	
37101	Nafta/Fuel	ISEKI	MT250-320-TS1910-3210-4270	141510201100	
37102	Nafta/Fuel		TX1500-2160-TX2160-TX2160HST	565004048790	
37104	Nafta/Fuel		4270 - 4370, 530, MT300	151310231100, 151310232900	
37105	Nafta/Fuel		F2400 - F2004B	151310231100	
01212	Nafta/Fuel	LOMBARDINI	400 - 6LD400C - 400V, 6LD260 - 260C, 6LD325 - 325C, 6LD360 - 360C, 6LD360V, 6LD435, LDA500 - 503 - 520 - 522 - 530	2175.032	

Art./Ref.	Note/Note	Brand	Applicazione/Application	Rif. Orig./Orig. Ref.	Immagine/Image
01213	Nafta/Fuel	LOMBARDINI	10LD400.2 - 10LD400.2/B, 10LD560.2 - 10LD360.2, 11LD535.3, 11LD625 - 11LD625.3, 12LD435.2 - 12LD435.2/B, 14LD475.2, 3LD 450 - 3LD 450S, 3LD 450 - 3LD 510, 3LD 510 - 3LD 510L, 3LD 535L, 4LD 640, 4LD 640 - 4LD 705, 4LD 820, 7LD600, 7LD665C - 7LD665F, 7LD740, 8LD600.2 - 8LD665.2 - 8LD740.2, 9LD560.2 - 9LD561.2, 9LD625 - 9LD625.3, LDA 100 - LDA 820, LDA 450 - LDA 510, LDA 710 - LDA 720 - LDA 740, LDA 904 - LDA 914 - LDA 940, LDA 96 - LDA 97	2175.009	
02042	Nafta/Fuel		LDW 1003, LDW 1204, LDW 1404, LDW 903	2175.143	
02058	Nafta /Fuel		5LD 2-3 cil 3/T, 11LD, 5LD 4 cil, 8LD, 9LD, CHD 1503, CHD 2004, CHD 2004/T, DVA 1030, DVA 1030/S, DVA 1200, LDW 1204, LDW 1404	2175.046	
02734	Olio Avvitabile//Oil Screw-on		10LD400.2 - 10LD400.2/B, 10LD560.2 - 10LD360.2, 11LD535.3, 11LD625 - 11LD625.3, 12LD435.2 - 12LD435.2/B, 14LD475.2, 400, 6LD260 - 260C, 6LD325 - 325C, 6LD360 - 360C, 6LD360V, 6LD400C - 400V, 6LD435, 8LD600.2 - 8LD665.2 - 8LD740.2, 9LD560.2 - 9LD561.2, 9LD625 - 9LD625.3, LDA500 - 503 - 520 - 522 - 530, LDA904 - LDA914 - LDA940	2175.040	
02736	Olio/Oil		6LD - 260, 6LD - 325, 6LD - 360, 6LD - 400, 6LD - 435, 6LD - 435/B1, LDA500 - 503 - 520 - 522 - 530	2175.019	
02746	Olio Avvitabile/Oil Screw-on		5LD 625.3 TURBO, 5LD 675.2, 5LD 675.3 - 5LD 675.4, 5LD 825.2 - 5LD 825.2L, 5LD 825.2 - 5LD 825.3L, 5LD 825.3 - 5LD 825.4, 5LD 930.3 - 5LD 930.4, LDA 672 - 673 - 674, LDA 832 - 833 - 834	2175.036	
03913	Nafta/Fuel		LGW 523, LGW 627	3730.106, 3730.121	
12711	Olio - Avvitabile/Oil - Screw-on		BASE 20 121D 475/2, FOCUS SERIE LDW502 - 602 - 903	2175.107	
14425	Nafta/Fuel		12LD 435.2 - 12LD 435.2/B, 14LD 475.2, 3LD 450 - 3LD 450S, 3LD 450 - 3LD 510, 3LD 510 - 3LD 510L, 3LD 535L, 4LD 640, 4LD 640 - 4LD 705 - 4LD 820, 7LD 600, 7LD 665C - 7LD 665F, 7LD 740, 8LD 600.2 - 8LD 665.2, 8LD 740.2, FOCUS SERIE LDW1204 - 1204T, FOCUS SERIE LDW502 - 602 - 903, LD 96 - LD 97, LDA 100 - LDA 820, LDA 450 - LDA 510, LDA 904 - LDA 914 - LDA 940, LDA710 - LDA 720 - LDA 740	2175.045	
14427	Olio /Oil		LDW 1204, LDW 12047T, LDW 1404, LOMBARDINI	2175.131	
14428	Aria /Air	602, 903, LDW - 602, LDW - 702, LDW 1003, LDW 502, LDW 502 Citycar, LDW 903, SERIE FOCUS LDW 502	2175.105, 2175.132, 2175.164		



Art./Ref.	Note/Note	Brand	Applicazione/Application	Rif. Orig./Orig. Ref.	Immagine/Image
14429	Aria /Air	LOMBARDINI	1204T, LDW 1204, LDW 12047T, LDW 1404, SERIE FOCS LDW 1204	2175.165	
38001	Olio /Oil		15LD - 315, 15LD - 350	2175.155	
32011	Aria /Air		LGA 226, LGA 184, LGA 225, LGK 184	2175.156	
32143	Olio /Oil		3LD 450 - 3LD 450S, 3LD 450 - 3LD 510, 3LD 510 - 3LD 510L, 3LD 535L, 4LD 640, 4LD 640 - 4LD 705 - 4LD 820, LDA 100 - LDA 820, LDA 450 - LDA 510, LDA 96 - LDA 97	2175.028	
32145	Olio /Oil		5LD 625.3 TURBO, 5LD 675.2, 5LD 675.3 - 5LD 573.4, 5LD 825.2 - 5LD 825.2L, 5LD 825.2 - 5LD 825.3L, 5LD 825.4 - 5LD 824.4L, 5LD 930.3 - 5LD 930.4, LDA 672 - LDA 673 - LDA 674, LDA 832 - LDA 833 - LDA 834	2175.011	
37995	Nafta/Fuel		15LD - 315, 15LD - 350	3730.096	
37996	Aria /Air		15LD - 315, 15LD - 350	2175.176	
37997	Olio /Oil		CHD 1503, CHD 2004, CHD 2004/T, DVA 1030, DVA 1030/S, DVA 1200	2175.104	
37998	Olio /Oil		10LD400.2 - 10LD400.2/B, 10LD560.2 - 10LD360.2, 11LD535.3, 11LD625 - 11LD625.3, 12LD435.2 - 12LD435.2/B, 12LD475.2, 9LD560.2 - 9LD561.2, 9LD625 - 9LD625.3	2175.044	
37999	Olio /Oil		665 - 7LD665C - 7LD665F, 7LD600, 7LD740 - 7LD710, LDA720 - LDA740	2175.025	
38000	Aria /Air		12LD, 9LD, LDW - 602, LDW - 702, LDW 1003, LDW 1204, LDW 1404, LDW 502, LDW 903	2175.124	
38017	Aria /Air		6LD - 325, 6LD - 360, 6LD - 400, 6LD - 435, LDA500 - 503 - 520 - 522 - 530	2175.050	
38018	Aria /Air		10LD400.2 - 10LD400.2/B, 10LD560.2 - 10LD360.2, 11LD535.3, 11LD625 - 11LD625.3, 9LD560.2 - 9LD561.2, 9LD625 - 9LD625.3	2175.048	

Art./Ref.	Note/Note	Brand	Applicazione/Application	Rif. Orig./Orig. Ref.	Immagine/Image	
<b>38019</b>	Cartuccia filt o combustibile / Fuel filter cartridge	<b>LOMBARDINI</b>	15LD - 225	2175.182		
<b>02058</b>	Nafta /Fuel	<b>RUGGERINI</b>	11 LD 625, L27, L40, L54, LDA672, LDA673, LDA674, LDA832	175.19		
<b>02734</b>	Olio Avvitabile//Oil Screw-on		RD180 - RD181 - RD200 - RD201, RD210 - RD211 - RD218 - RD220, RD240 - RD270 - RD278	175.31		
<b>02746</b>	Olio Avvitabile/Oil Screw-on		CRD 1002/2 - CRD 951/2, CRDK 100/2, MW300 - 301 - 350 - MD 351, P 101/2 - P105/2, PK 105/2 - PM 105/2, RD 901/2 - RDK 901/2, RD 92/2, RD 952 - RDM 952, RDM 901/2 - RD 951/2	175.22		
<b>03912</b>	Nafta con piastra/Fuel with plate		RUGGERINI	RUGGERINI	391.12	
<b>11846</b>	Nafta - cartuccia/Fuel - Cartridge		71, MC 70, MC 71 BRIO, MC70, MD 150, MD 170, MD 190, MICRO 51	175.32		
<b>14425</b>	Nafta/Fuel		CRD 95 - CRD 100 - CRD 951, P101 - RP 170 - RP 178, RD 101 - RD 105 - RD 850, RD 80 - RD 90 - RD 95 - RD 100, RD 900 - RD 901 - RD 920, RD 950, RP 850 - RP 900, RW 140 - RW 148	175.20		
<b>32145</b>	Olio/Oil	CRD 951, RD95/1	175.03			
<b>01011</b>	Gasolio - Cartuccia /fuel - Cartridge	<b>PASQUALI</b>	(TUTTI I MODELLI / ALL MODELS)	-		
<b>02734</b>	Olio Avvitabile//Oil Screw-on		PASQUALI	-		
<b>03912</b>	Nafta con piastra/Fuel with plate		PASQUALI	-		
<b>02058</b>	Nafta /Fuel	<b>SLANZI</b>	DVA 2000 - DVA 2200, DVA 2600 - DVA 2900	2175.084		

Art./Ref.	Note/Note	Brand	Applicazione/Application	Rif. Orig./Orig. Ref.	Immagine/Image
02722	Filtro a secco/Filter	SLANZI	DVA 1030, DVA 1030 MARINO, DVA 1030 S2, DVA 700, DVA 700 S, DVA 790, DVA 790S, DVA 920	40.84.05	
02734	Olio Avvitabile//Oil Screw-on		SERIE 105 - DS 2000	2175.068	
02746	Olio Avvitabile/Oil Screw-on		DVA 1550 S2, DVA 1750, DVA 2350	2175.071	
32143	Olio/Oil		DVA 1550	2175.090	
37101	Nafta/Fuel	YANMAR	-	104500-55710, 114050-55510, 114050-55510, 104500-55710	
37104	Nafta/Fuel		-	129100-55650	
37105	Nafta/Fuel		-	114550-55700, 124550-55700	

**FILTRI ORIGINALI LOMBARDINI**

FILTRE ORIGINAL LOMBARDINI  
 FILTERS ORIGINAL LOMBARDINI  
 FILTER ORIGINAL LOMBARDINI  
 FILTROS ORIGINAL LOMBARDINI



Art./Ref.	Descrizione/Description	Posizione/Position	Brand	Rif. Orig./Orig. Ref.
LOMB2175.009	Filtro piccoli motori	1	LOMBARDINI	2175.009
LOMB2175.032		1		2175.032
LOMB3730.121		3		3730.121
LOMB1301.053	Parte trasparente prefilter o	2		1301.053
LOMB1301.069		2		1301.069

**FILTRI CARBURANTE IN PLASTICA**

FILTRES CARBURANT EN PLASTIQUE

PLASTIC FUEL FILTERS

KRAFTSTOFFFILTER AUS KUNSTSTOFF

FILTROS CARBURANTE DE PLASTICO

**Note:** Filtri carburante in plastica con cartuccia in rete.

**Notes:** Plastic fuel filter with mesh cartridge.

Art./Ref.	Descrizione estesa/Descrizione estesa
<b>81239</b>	Filtro carburante in plastica con cartuccia in rete, lungo 120 mm e ø 6/8 mm - MADE IN ITALY
<b>12239</b>	Filtro carburante in plastica con cartuccia in rete, lungo 204 mm e ø 8/10 mm.
<b>91239</b>	Filtro carburante in plastica con cartuccia in rete, lungo 204 mm e ø 8/10 mm - MADE IN ITALY

**CHIAVE FILTRO A CATENA**

CLE FILTRE A CHAINE

CHAIN KEY FOR FILTER

FILTERSCHLÜSSEL MIT KETTE

LLAVE FILTRO CON CADENA



Art./Ref.	Note/Note
<b>01030</b>	Peso 0,31 Kg. // Weight 0,31 Kg.

**FILTRO ARIA ADATTABILE**

FILTRE AIR PERCÉ ADAPTABLE

AIR FILTER WITH CENTRAL HOLE ADAPTABLE

LUFTFILTER MIT ZENTRALBOHRUNG PASSEND ZU

FILTRO DE AIRE CON ORIFICIO CENTRAL ADAPTABLE



Art./Ref.	Ø interno mm/ Inside Ø mm	Ø esterno mm/ Outside Ø mm	Brand	Applicazione/Application	Rif. Orig./Orig. Ref.
<b>08263</b>	39	140	<b>COTIEMME</b>	CA350	5/1768

**FILTRO ARIA CON ATTACCO DISASSATO ADATTABILE**

FILTRE AIR DESAXÉ ADAPTABLE POUR

AIR FILTER WITH DISAXED CONNECTION ADAPTABLE TO

LUFFILTER MIT VERSCHOBENEM ANSCHLUSS PASSEND ZU

FILTRO DE AIRE CON ENGANCHE DESENCAJADO ADAPTABLE



Art./Ref.	Ø interno mm/ Inside Ø mm	Ø esterno mm/ Outside Ø mm	Brand	Applicazione/Application	Rif. Orig./Orig. Ref.
08260	39	120	ACME	AL215-AL290	387140

**FILTRO ARIA CON FORO CENTRALE ADATTABILE**

FILTRE AIR PERCÉ ADAPTABLE POUR

AIR FILTER WITH CENTRAL HOLE ADAPTABLE TO

LUFFILTER MIT ZENTRALBOHRUNG PASSEND ZU

FILTRO DE AIRE CON ORIFICIO CENTRAL ADAPTABLE



Art./Ref.	Ø interno mm/ Inside Ø mm	Ø esterno mm/ Outside Ø mm	Brand	Applicazione/Application	Rif. Orig./Orig. Ref.
08264	43	145	LOMBARDINI	LA 400 - 490	3700.047

**FILTRO ARIA CON ATTACCO DISASSATO ADATTABILI MOTORI**

FILTRE AIR DESAXÉ POUR MOTEURS ADAPTABLE

AIR FILTER WITH DISAXED CONNECTION FOR ADAPTABLE

LUFFILTER MIT VERSCHOBENEM ANSCHLUSS FÜR PASSEND ZU

FILTRO DE AIRE CON ENGANCHE PARA ADAPTABLE



Art./Ref.	Ø interno mm/ Inside Ø mm	Ø esterno mm/ Outside Ø mm	Brand	Applicazione/Application	Rif. Orig./Orig. Ref.
08261	39	145	ACME	AL330	387141
08262	50	145		FE82-VT88-VT94- AL480-550	387142

**PREFILTRI CICLONE COMPLETI ADATTABILI**

CYCLON AIR FILTER COMPLETE ADAPTABLE

CYCLON AIR FILTER COMPLETE ADAPTABLE

VORFILTER KPLT. PASSEND ZU

PREPULIFICADORES CICLON ADAPTABLE

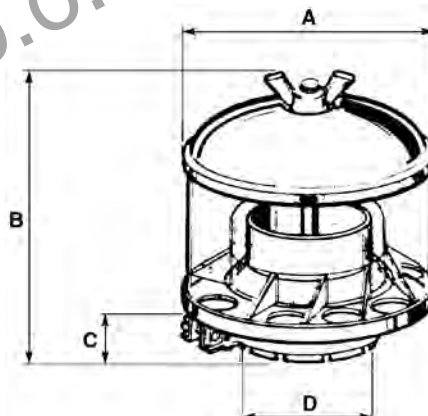

Art./Ref.	A mm	B mm	C mm	D mm	Note/Note	Brand	Applicazione/Application	
<b>00385</b>	135	120	22	58	Parte trasparente Art. 00716 /Transparent part Art. 00716	<b>LAMBORGHINI</b>	LAMBORGHINI	-
<b>00385</b>	135	120	22	58	Parte trasparente Art. 00716 /Transparent part Art. 00716	<b>LANDINI</b>	5500, 5830, 5840, 5860, 5870, 6030, 6040, 6060, 6070, 6500, 6830, 6840, 6860, 6870, 7500, 7830, 7860, 7870, 8500, 8830, 8860, 8870, C4500, C6500, C6830, CF6830, CINGOLATI: C4830, CINGOLATI: C5500, CINGOLATI: C5830, CINGOLATI: CF4830, CINGOLATI: CF5030, CINGOLATI: CF5830, CINGOLATI: CF6030, CINGOLATI: CF6060, TREKKER: C75, TREKKER: CF65, TREKKER: CF75	976611M91
<b>00383</b>	100	85	16	40	Parte trasparente Art. 00718 /Transparent part Art. 00718	<b>LOMBARDINI</b>	LOMBARDINI	6727.031
<b>00384</b>	120	105	18	48	Parte trasparente Art. 00717 /Transparent part Art. 00717		LOMBARDINI	6727.028
<b>00385</b>	135	120	22	58	Parte trasparente Art. 00716 /Transparent part Art. 00716	<b>MASSEY FERGUSON</b>	MASSEY FERGUSON	976611M91
<b>00383</b>	100	85	16	40	Parte trasparente Art. 00718 /Transparent part Art. 00718	<b>RUGGERINI</b>	RUGGERINI	670.05
<b>00384</b>	120	105	18	48	Parte trasparente Art. 00717 /Transparent part Art. 00717		RUGGERINI	670.06
<b>00383</b>	100	85	16	40	Parte trasparente Art. 00718 /Transparent part Art. 00718	<b>SLANZI</b>	SLANZI	6727.031
<b>00384</b>	120	105	18	48	Parte trasparente Art. 00717 /Transparent part Art. 00717		SLANZI	6727.028
<b>00385</b>	135	120	22	58	Parte trasparente Art. 00716 /Transparent part Art. 00716		DVA 1750, SLANZI	6727.030
<b>00436</b>	173	130	28	65	Parte trasparente Art. 00788 /Transparent part Art. 00788	-	-	-
<b>00442</b>	270	212	57	96	Parte trasparente Art. 00789 /Transparent part Art. 00789	-	-	-

**FILTRO ARIA PER MOTOZAPPE CON CAPPELLOTTA ADATTABILE**

FILTRE AIR ADAPTABLE POUR  
AIR FILTER ADAPTABLE TO  
LUFFILTER PASSEND ZU  
FILTRO AIRE ADAPTABLE



Art./Ref.	H mm	Ø esterno mm/ Outside Ø mm	Flangia Collegamento Ø/ Connection Flange Ø	Note/Note	Brand	Applicazione/ Application
08281	209	96	40	Massa filt ante Art. 01020 /Art. 01020 Filtering element	BETA	B125
08281	209	96	40	Massa filt ante Art. 01020 /Art. 01020 Filtering element	BRUNI	BRUNI
08281	209	96	40	Massa filt ante Art. 01020 /Art. 01020 Filtering element	EUROSYSTEMS	LAUZ
08281	209	96	40	Massa filt ante Art. 01020 /Art. 01020 Filtering element	JLO	L101, L125, L152
08281	209	96	40	Massa filt ante Art. 01020 /Art. 01020 Filtering element	MAB	MAB
08281	209	96	40	Massa filt ante Art. 01020 /Art. 01020 Filtering element	MORINI	C27
08281	209	96	40	Massa filt ante Art. 01020 /Art. 01020 Filtering element	SEP	SEP
08281	209	96	40	Massa filt ante Art. 01020 /Art. 01020 Filtering element	ZANETTI	ZANETTI

**FILTRO ARIA A BAGNO D'OLIO CON PREFILTRO A CICLONE ADATTABILE**

FILTRE A AIR AVEC PREFILTRE COMPLET ADAPTABLE  
AIR FILTER WITH CYCLON AIR FILTER ADAPTABLE  
LUFFILTER IN ÖLBAD MIT VORFILTER PASSEND ZU  
FILTRO DE AIRE EN BAÑO DE ACEITE CON PREPURIFICADOR A CICLÓN ADAPTABLE



Art./Ref.	H mm	Ø esterno mm/ Outside Ø mm	Flangia Collegamento Interasse/ Connection Flange Interasse	Flangia Collegamento Ø/ Connection Flange Ø	Note/Note	Brand	Applicazione/ Application	Rif. Orig./ Orig. Ref.
08270	285	130	72	34	Massa filt ante Art. 01037/ Art. 01037 Filtering element	LOMBARDIN	4LD 640 - 4LD 705 - 4LD 820, 7LD 600, 7LD 665C - 7LD665F, 7LD 740, LDA 100 - LDA 820, LDA 710 - LDA 720 - LDA740, LDA 96 - LDA 97	3700.140
08288	285	130	56	34	Massa filt ante Art. 00992 / Art. 00992 Filtering element		400 - 6LD400C - 400V, 503, 520, 522, 530, 6LD260 - 260C, 6LD325 - 325C, 6LD360 - 360C, 6LD360V, LDA 500	3700.107

Art./Ref.	H mm	Ø esterno mm/ Outside Ø mm	Flangia Collegamento Interasse/ Connection Flange Interasse	Flangia Collegamento Ø/ Connection Flange Ø	Note/Note	Brand	Applicazione/Applica- tion	Rif. Orig./ Orig. Ref.
<b>08290</b>	285	130	62	32	Massa filt ante Art. 00992 - Parte trasp Art. 03484/ Filtering element Art. 00992 - Transparent part Art. 03484	<b>LOMBARDINI</b>	3LD 450 - 3LD 450S, 3LD 510 - 3LD 510L, 3LD 535L, 4LD 640, LDA 450 - LDA 510	3700.102
<b>08292</b>	270	120	56	32	Massa filt ante Art. 00984 - Parte trasp. Art. 03491/ Filtering element Art. 00984 - Transparent part Art. 03491		325, 325C, 360, 360C, 400, 400C, 400V, 520, 530, 6 LD 260, 6 LD 260C, 6 LD 360V, LDA 500	3700.109
<b>08272</b>	275	130	64	34	Massa filt ante Art. 00992 - Parte trasp Art. 03484/ Filtering element Art. 00992 - Parte trasp Art. 03484	<b>RUGGERINI</b>	RD 101 - RD 105 - RD 850, RD 80 - RD 90 - RD 95 - RD 100, RD 900 - RD 901, RD 920 - RD 950, RF 101 - RF 109 - RF 120, RF 121 - RF 129 - RF 130, RF 139 - RF 140 - RF 148, RF 149 - RW 101 - RW 120, RF 80 - RF 81 - RF 88 - RF 89, RF 90 - RF 91 - RF 100, RP 850 - RP 900, RW 128 SERIE BRIO	388.29

**FILTRO ARIA A BAGNO D'OLIO CON Cappelotto ADATTABILE**

FILTRE A AIR AVEC PREFILTRE CABOCHON ADAPTABLE

AIR FILTER WITH HEAD ADAPTABLE

LUFTFILTER IN ÖLBAD MIT KAPPE PASSEND ZU

FILTRO DE AIRE EN BAÑO DE ACEITE CON TAPA ADAPTABLE



Art./Ref.	H mm	Ø esterno mm/ Outside Ø mm	Flangia Collegamento Interasse/ Connection Flange Interasse	Flangia Collegamento Ø/ Connection Flange Ø	Note/Note	Brand	Applicazione/Application	Rif. Orig./ Orig. Ref.
<b>08269</b>	250	130	72	34	Massa filt ante Art. 00992 - Cappelotto Art. 08299/ Filtering element Art. 00992 - Filter head Art. 08299	<b>LOMBARDINI</b>	100, 4 LD 640, 640L, 665 - 7LD665C - 7LD665F, 705, 7LD600, 7LD740, 820, 820L, 96, 97, LDA 710 - LDA 720 - LDA 740, LDA 91	3700.139
<b>08289</b>	239	130	62	34	Massa filt ante Art. 00992 - Cappelotto Art. 08299/ Filtering element Art. 00992 - Filter head Art. 08299		3LD 450 - 3LD 450S, 3LD 510 - 3LD 510L, 3LD 535L, 4LD 640, LDA 450 - LDA 510	3700.101
<b>08291</b>	250	120	56	32	Massa filt ante Art. 00992 - Cappelotto Art. 08297/ Filtering element Art. 00992 - Filter head Art. 08297		325, 360, 360C, 400, 400C, 400V, 520, 530, 6 LD 260, 6 LD 260C, 6 LD 360V, LDA 500	3700.111



**FILTRO ARIA COMPLETO ADATTABILE**

FILTRE AIR COMPLETE ADAPTABLE  
 COMPLETE AIR FILTER ADAPTABLE  
 LUFT FILTER KPLT PASSEND ZU  
 FILTRE AIRE COMPLETO ADAPTABLE

Art./Ref.	Note/Note	Brand	Applicazione/Application	Rif. Orig./Orig. Ref.
15196	Filtro a bagno d'olio/Oil bath filter	FIAT	45.66/DT, 50.66/DT, 55.56/DT, 55.88/DT, 60.56/DT, 60.93/DT, 65.56/DT, 65.93/DT, 70.56/DT, 70.88/DT, 72.93/DT, 80.66/DT, 80.88/DT, 82.93/DT	-
15196	Filtro a bagno d'olio/Oil bath filter	NEW HOLLAND	L60, L65, L75, TK60-65, TK60-65 M, TK60-65 V, TK70-65 M, TK80-65, TL100, TL65, TL70, TL80, TL90	5136557, 5136558, 8323083
15196	Filtro a bagno d'olio/Oil bath filter	FORD	3435, 3935, 4635, 4835, 5635	5136557, 5136558, 8323083



**GANCIO FILTRO ARIA**

CROCHET FILTRE AIR  
 AIR FILTER HITCH  
 VERSCHLUSS FÜR LUFTFILTER  
 JUNTA FILTRO DE AIRE

Art./Ref.	Note/Note
01342	Peso 0,03 Kg/Weight 0,03 Kg



**CAPPELLOTTI FILTRO**

CABOCHONS POUR FILTRES  
 FILTERS HEADS  
 FILTERDECKEL  
 TAPA FILTRO

Art./Ref.	H mm	Ø interno mm/ Inside Ø mm	Ø esterno mm/ Outside Ø mm	Note/Note	Brand	Applicazione/ Application
08299	43	45	95	Filtro Art. 08299/Filter Art. 08299	A.M.A.	PER FILTRO ART. 08269
08297	50	56	125	Filtro Art. 08291/Filter Art. 08291		PER FILTRO ART. 08291



**PREFILTRO CICLONE COMPLETO ADATTABILE RUGGERINI**

PREFILTRE COMPLET ADAPTABLE RUGGERINI  
 CYCLON AIR FILTER COMPLETE ADAPTABLE TO RUGGERINI  
 VORFILTER KPLT. PASSEND ZU RUGGERINI  
 PREPURIFICADORES CICLON COMPLETAS ADAPTABLE RUGGERINI

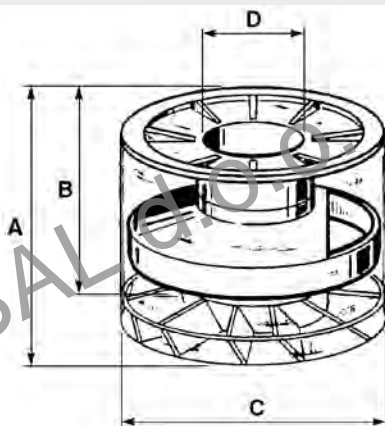

Art./Ref.	A mm	B mm	C mm	D mm	Brand	Applicazione/Application	Rif. Orig./Orig. Ref.
00369	87	60	84	38	RUGGERINI	MD 150, RD180, RD210, RD220	670.14
00382	105	66	112	48		CRD/2, RD/2	670.15

**PARTI TRASPARENTI PER PREFILTRI CICLONE ADATTABILI**
*PARTIES TRANSPARENTES POUR PREFILTRES CYCLON ADAPTABLE*
*ELEMENTS ADAPTABLE CYCLON FILTERS*
*GLÄSER FÜR VORFILTER PASSEND ZU*
*PARTES TRASPARENTES PARA PREPURIFICADORES CICLÓN ADAPTABLE*

Art./Ref.	H mm	Ø esterno mm/ Outside Ø mm	Ø interno mm/ Inside Ø mm	Note/Note	Brand	Applicazione/ Application	Rif. Orig./ Orig. Ref.
<b>00717</b>	60	117	47	Prefilt o Art. 00384/Prefil er Art. 00384	<b>ACME</b>	ADN 54-60	059038
<b>00718</b>	47	100	40	Prefilt o Art. 00383/Prefil er Art. 00383		ACME	059130
<b>00718</b>	47	100	40	Prefilt o Art. 00383 /Prefil er Art. 00383	<b>BETA</b>	BETA	-
<b>00788</b>	87	173	65	Prefilt o Art. 00436/Prefil er Art. 00436	<b>FIAT</b>	FIAT	-
<b>00718</b>	47	100	40	Prefilt o Art. 00383 /Prefil er Art. 00383	<b>JLO</b>	JLO	-
<b>00716</b>	63	136	58	Prefilt o Art. 00385/Prefil er Art. 00385	<b>LAMBORGHINI</b>	LAMBORGHINI	-
<b>00788</b>	87	173	65	Prefilt o Art. 00436/Prefil er Art. 00436	<b>LANDINI</b>	LANDINI	-
<b>00789</b>	101	270	96	Prefilt o Art. 00442/Prefil er Art. 00442		LANDINI	-
<b>00718</b>	47	100	40	Prefilt o Art. 00383/Prefil er Art. 00383	<b>MAB</b>	MAB	-
<b>00718</b>	47	100	40	Prefilt o Art. 00383/Prefil er Art. 00383	<b>MINARELLI</b>	MINARELLI	-
<b>00718</b>	47	100	40	Prefilt o Art. 00383/Prefil er Art. 00383	<b>MORINI</b>	MORINI	-
<b>00718</b>	47	100	40	Prefilt o Art. 00383/Prefil er Art. 00383	<b>PASBO</b>	PASBO	-
<b>00717</b>	60	117	47	Prefilt o Art. 00384/Prefil er Art. 00384	<b>RUGGERINI</b>	RD901/2 - RD92/2	059.38
<b>00718</b>	47	100	40	Prefilt o Art. 00383/Prefil er Art. 00383		RUGGERINI	059.36
<b>00717</b>	60	117	47	Prefilt o Art. 00384/Prefil er Art. 00384	<b>SLANZI</b>	DVA 1030	9710.084
<b>00718</b>	47	100	40	Prefilt o Art. 00383/Prefil er Art. 00383		SLANZI	9710.099
<b>00718</b>	47	100	40	Prefilt o Art. 00383/Prefil er Art. 00383	<b>ZANETTI</b>	ZANETTI	-

**PARTI TRASPARENTI PER PREFILTRI CICLONE ADATTABILI LOMBARDINI**
*PARTIES TRANSPARENTES POUR PREFILTRES CYCLON ADAPTABLE LOMBARDINI*
*ELEMENTS ADAPTABLE TO TO LOMBARDINI CYCLON FILTERS*
*GLÄSER FÜR VORFILTER PASSEND ZU LOMBARDINI*
*PARTES TRASPARENTES PARA PREPURIFICADORES CICLÓN ADAPTABLE LOMBARDINI*

Art./Ref.	H mm	Ø esterno mm/ Outside Ø mm	Ø interno mm/ Inside Ø mm	Brand	Applicazione/Application	Rif. Orig./ Orig. Ref.
<b>00095</b>	67	120	60	<b>LOMBARDINI</b>	450, 451, 503, 520, 522, 530, 6 LD 260, 6 LD 325, 6 LD 360, 6 LD 400, LDA500	1301.053
<b>00096</b>	73	140	70		100, 3 LD 450, 3 LD 510, 4 LD 640, 4 LD 705, 510 705, 720, 820, 832, 904, 914, 96, 97, LDA450	1301.069

**PARTI TRASPARENTI PER PREFILTRI CICLONE ADATTABILI**

PARTIES TRANSPARENTES POUR PREFILTRES CYCLON ADAPTABLE

ELEMENTS ADAPTABLE CYCLON FILTERS

GLÄSER FÜR VORFILTER PASSEND ZU

PARTES TRASPARENTES PARA PREPURIFICADORES CICLÓN ADAPTABLE

Art./Ref.	H mm	Ø esterno mm/ Outside Ø mm	Ø interno mm/ Inside Ø mm	Brand	Applicazione/Applic- ation	Rif. Orig./Orig. Ref.
03484	67	130	60	ACME	SERIE ADN MOTOZAPPE	059159
03492	70	135	62		ADN37 - ADN48	059132
03493	70	146	62		ADN45-48-54-60	059151
03484	67	130	60	LOMBARDINI	LDA450/500 - 500/530	3700.102
03484	67	130	60	RUGGERINI	RF80 - RF140	059.90
03491	54	115	55		MC70 - MC71	060-06



**MASSE FILTRANTI ADATTABILI**

ELEMENTS DE FILTRE ADAPTABLE

FILTER ELEMENTS ADAPTABLE TO

FILTERMASSEN PASSEND ZU

ELEMENTOS FILTRANTES ADAPTABLE

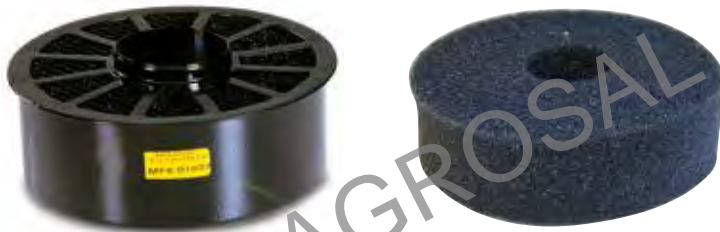

Art./Ref.	Brand	Applicazione/Application	Rif. Orig./Orig. Ref.
00984	ACME	ADN37-43-45-48-54-60	359127
01020	BETA	B125	-
01020	BRUNI	BRUNI	-
01020	EUROSYSTEMS	EUROSYSTEMS	-
01020	JLO	L101 - 125 - 152	-
00988	LOMBARDINI	503 - 520 - 522 - 530, 6LD260 - 6LD325 - 6LD360, LDA500	5496.071
01037		3LD450 - 3LD450S, 3LD510 - 3LD510L, 3LD535L, 4LD640, 4LD640 - 4LD705, 4LD820, 7LD600, 7LD665C - 7LD665F - 7LD740, LDA100 - LDA820, LDA450 - LDA510, LDA710 - LDA720 - LDA740, LDA96 - LDA97	5496.111
18931		400, 6LD260 - 260C, 6LD325 - 325C, 6LD360 - 360C, 6LD360V, 6LD400C - 400V, 6LD435, LDA500 - 503 - 520 - 522 - 530	5496.113
18932		10LD400.2 - 10LD400.2/B, 10LD560.2 - 10LD360.2, 11LD535.3, 11LD625 - 11LD625.3, 3LD 450 - 3LD 450S, 3LD 510 - 3LD 510L, 3LD 535L, 4LD 640, 4LD 705 - 4LD 820, 7LD600, 7LD665C - 7LD665F, 7LD740, 8LD600.2 - 8LD665.2 - 8LD740.2, 9LD560.2 - 9LD561.2, 9LD625 - 9LD625.3, LDA100 - LDA820, LDA450 - LDA510, LDA710 - LDA720 - LDA740, LDA904 - LDA914 - LDA940, LDA96 - LDA97	5496.110
19144		LDA672 - LDA673 - LDA674, LDA832 - LDA833 - LDA834	5496.074
01020	MAB	MAB	-
01020	MORINI	C27	-
01020	PASBO	PASBO	-
00992	RUGGERINI	RD180 - RD210, RF80 - RF140	359.26
01020	SEP	SEP	-
00992	SLANZI	DVA1030, DVA700 - DVA700S, DVA790 - DVA790S, DVA920	5496.132
01020	ZANETTI	17512	-

**MASSE FILTRANTI ADATTABILI**

ELEMENTS DE FILTRE ADAPTABLE  
 FILTER ELEMENTS ADAPTABLE TO  
 FILTERMASSEN PASSEND ZU  
 ELEMENTOS FILTRANTES ADAPTABLE

Riferimento AMA	OEM	Riferimento FIAAM	Riferimento Tecocar	Riferimento M+H	Riferimento Donaldson	Riferimento UFI	Note
01011	-	FA5013	-	-	-	26.644.00	CLEAN MG042
01212	2175.032	FA4758	N106	P53	-	26.660.00	-
01213	2175.009	FA4746	N1132	P65	-	26.622.00	-
02042	2175.143	FP4935A	RN58B	WK842/1	P55-0588	24.355.00	CAV 7176-496A
02058	2175.046	FP4683	RN45	WK731	"P55-0440, P55-0943, P55-3004, P77-9451"	-	-
02722	40.84.05	FLI6229	A100	-	-	27.738.00	-
02734	2175.040	FT4756	R11	W712/2	P55-0589	23.131.00	SOFIMA S 8540 R
02736	2175.019	FH3473	-	-	-	22.017.00	-
02746	2175.036	-	-	W719/12	P55-0227	23.117.00	-
03912	391.012	-	-	-	-	26.653.00	-
03913	3730.121	FT4648	B7	WK43/12	-	31.001.00	BOSCH F0012 - BALDWIN BF840
11846	175.32	-	-	-	-	26.679.00	FBN N11.01484 - SOFIMA S 6679 N
12711	2175.107	FT5149	-	W752 W753	-	23.262.00	BALDWIN B7276
14425	2175.045	FP4885	RN297	WK712/12	P55-0345	24.352.00	-
14427	2175.131	FT5148	R511	WK712/8	P55-2849	23.133.00	-
14428	2175.164	PA7099	-	C2348	-	30.997.00	FRAM CA5337
14429	2175.165	PA7001	A396	C2860/3	P528225	30.851.00	SOFIMA S 6930 A
32011	2175.156	PA7060	-	-	-	30.921.00	SOFIMA S 3921 A
32143	2175.028	FT4701	R38	W712/31	-	23.143.00	FRAM PH4515
32145	2175.011	FA4581	OP35	-	-	25.424.00	-
37099	15853-99170	FT5389	R193	W68	-	23.424.00	FLEETGUARD LF3925 - SOFIMA S 3424 R
37100	15221-43080	FT5006	RN127B	WK812	P55-0127	24.326.00	-
37101	141510201100	-	-	P43/1	P50-2134	26.672.00	BALDWIN PF937 - YANMAR 104500-55710
37102	565004048790	-	-	-	-	26.677.00	WIX 33264 - MITSUBISHI MM404879 - SOFIMA S 6677 N
37103	15231-43560	FEM4013	-	P33	P50-2138	26.680.00	FLEETGUARD FF5104 - HENGST E78KP
37104	15521-43160	-	-	-	P50-2161	26.681.00	BALDWIN PF717 - HENGST E77KP - MITSUBISHI MM433093 - YANMAR 129100-55650
37105	16271-43560	-	-	-	P50-2166	26.683.00	BALDWIN PF981 - YANMAR 124550-55700 - JOHN DEERE CH10479
37995	3730.096	-	-	-	P55-0902	-	-
37996	2175.176	-	-	-	-	27.201.03	SOFIMA S 7201 A
37997	2175.104	FT4797	R42	W719/11	-	23.151.00	-
37998	2175.044	FT1522	-	-	-	22.019.00	SOFIMA S 2219 Z
37999	2175.025	FA4723	-	-	-	25.547.00	-
38000	2175.124	-	A748	C11103/2	P77-2578	-	-
38001	2175.155	-	-	-	-	22.025.01	SOFIMA S 2225 Z
38017	2175.050	FL6044	A663	C1426	-	27.707.00	-
38018	2175.048	FL6617	-	-	-	27.905.00	-
38019	2175.182	-	-	-	-	-	F.B.N. N11.05086

# 1.7.7 Marmitte, collettori e gomiti

Mufflers, collectors & elbows





**ama**

**Ricambi & accessori per macchine agricole**  
SPARE PARTS & ACCESSORIES FOR AGRICULTURAL MACHINE

Tutti gli articoli della presente sezione, prodotti da AMA SPA e/o da terzi per conto di AMA, sono adattabili ("non originali") alle marche indicate ai sensi di quanto previsto dal REG. CE n. 1400/2002. I diritti sui marchi citati appartengono ai legittimi proprietari e il loro uso ha l'esclusiva finalità di consentire all'utilizzatore la comparazione dei diversi prodotti. All items of this section, manufactured by AMA SPA and/or any third party on behalf of AMA, are adaptable ("non-original") to the brands listed under the provisions of the REG. CE n. 1400/2002. The rights on the trademarks belong to their respective owners and their usage is only aimed to allow the user to compare different products.

**MARMITTE ADATTABILI A**

SILENCIEUX ADAPTABLE  
MUFFLERS ADAPTABLE TO  
SCHALLDÄMPFER PASSEND ZU  
SILENCIADORES ADAPTABLE

Art./Ref.	Ø Attacco mm/ Attack Ø mm	Altezza mm/ Height mm	Note/Note	Brand	Applicazione/Application	Rif. Orig./Orig. Ref.	Immagine/Image
<b>00561</b>	20	120	Flangia di fissaggio a 2 fori interasse 47 mm / 2 holes fixing flang , 47 mm holes distance	<b>ACME</b>	AL 215 HP 5,5, AL 290 HP 7,5, AL 330 HP 10	526.156	
<b>03458</b>	30	290	Flangia a 2 fori interasse 60 mm / 2 hole flange 60 mm hole distance		VT 88 - 15 HP (BCS), VT 94	526.104	
<b>04094</b>	57	1115	Fascetta - Clamp Art. 03387	<b>FENDT</b>	300, 309	-	
<b>03363</b>	60	820	Tipo quadro lungo/Square type long - Fascetta/Clamp code ama 03387	<b>FIAT</b>	100.90, 1000, 1180, 1280, 1300, 1380, 140, 1580, 180, 1880, 850, 880, 90, 95.55, 955	44905778, 4987847, 4987876, 4997485, 5101709, 5101810, 5109915, 5111563, 5111661, 5112117, 5116897, 5123236, 5134339, 5146414, 5152184	
<b>03402</b>	46	730	Tipo lungo tondo/Round type long - Fascetta/Clamp code ama 03382 - Coperchietto/Cap code ama 05618		30, 300, 350, 40, 420, 440, 45.66, 450, 455, 470, 474, 480, 50, 500, 540, 55.65, 55.66, 570, 60, 60.65, 60.66, 640, 670, 680, 70, 70.65, 70.66, 780, 80.60, 80.65, 80.70	4957068, 4958660, 4980843, 4980847, 4981062, 4981066, 4981162, 4981243, 4981266, 4982306, 4998293, 5011631, 5011632, 5011657, 597983, 597984	
<b>03404</b>	45	500	Tipo corto con parapioggia/Short type with cap - Fascetta/Clamp ama code 03382 - Coperchietto/Cap ama code 05618		300, 350, 355, 455, 500, 505, 605, 80.50, 80.70	580710	
<b>04020</b>	60	1050	Flangia quadra a 4 fori interasse 70 mm - 4 hole square flange 70 mm hole distance		10 FL, 80, 90, AD 8 - 9 - 10	4964158, 4965720, 4970708, 4970735, 4979464, 4979467, 4981134, 4981139, 592752	
<b>04051</b>	60	530	Con parapioggia/With cap - Fascetta/Clamp ama code 04052	60, 70, 80	554317, 560740		

Art./Ref.	Ø Attacco mm/ Attack Ø mm	Altezza mm/ Height mm	Note/Note	Brand	Applicazione/Application	Rif. Orig./Orig. Ref.	Immagine/Image
04054	46	675	Tipo corto con parapoggia/Short type with cap - Fascetta/Clamp ama code 03382 - Copercinetto/ Cap ama code 05618	FIAT	300, 350, 355, 455, 500, 505, 605, 80.50, 80.70	4981062, 589710	
04055	46	440	Scarico laterale tipo vigneto e frutteto/Side exhaust - Fascetta/Clamp ama code 03382		55.65, 565, 60.65, 65, 665, 70.65, 765, 80.65	5127341	
04075	80	1245	-		1580, 160, 180, 1880, 55, 55.60, 60, 60.66, 70, 70.66, 80, 80.66	5109906, 5109907, 5119906, 5123288	
04092	42	520	Scarico laterale in basso - Side low exhaust Prolunga curva - Bending extension Art. 03406 Fascetta - Clamp Art. 02612		45.66, 50, 55.65, 55.66, 60.65, 60.66, 70.65, 70.66, 80.65, 80.66	44905942, 5134942	
04144	46	680	Tipo quadro/Square type Fascetta/Clamp ama code 03382		446, 45.66, 465, 466, 55, 55.46, 55.66, 565, 566, 570, 580, 60, 60.65, 60.66, 65, 65.46, 65.66, 665, 666, 680, 70, 70.65, 70.66, 765, 766, 780, 80, 80.65, 80.66, 85.55	4997325, 5100920, 5103482, 5122884, 5131866, 5135118, 5157240	
04147	46	680	Tipo Quadro - Square type Fascetta - Clamp Art. 03382 Super silenziosa - Super silent		446, 45.66, 465, 466, 55, 55.46, 55.66, 565, 566, 570, 580, 60, 60.65, 60.66, 65, 65.46, 65.66, 665, 666, 680, 70, 70.65, 70.66, 765, 766, 780, 80, 80.65, 80.66, 85.55	5100920, 5131866	
04830	44	960	Fascetta - Clamp Art. 02612/ Collier Art.02612		AD4FL4, D, FL, L	598384, 79018848	
04846	46	390	Fascetta/Clamp ama code 03382		TRATTORI VIGNETO	-	
14365	60	830	Tipo quadro/Square type - Fascetta/Clamp ama code 03387		140.90DT, 160.90DT, 180.90DT, 85.90DT, 88.94DT, F130, F140	5146629	
03455	30	250	Flangia a 2 fori interasse a 56 mm / 2 hole flange 56 mm hole distance		JLO	101-152 BETA B210 PER MOTOZAPPA	-
03456	30	140	Flangia a 2 fori interasse a 56 mm / 2 hole flange 56 mm hole distance	JLO 101-125-152 PER MOTOZAPPA		-	

Art./Ref.	Ø Attacco mm/ Attack Ø mm	Altezza mm/ Height mm	Note/Note	Brand	Applicazione/Application	Rif. Orig./Orig. Ref.	Immagine/Image
04059	46	720	Fascetta - Clamp Art. 02612/ Collier art. 02612	LANDINI	5000	0973083	
04068	46	530	Flangia triangolare a 3 fori interasse 75 mm - 3 hole triangular flange 75 mm hole distance		CINGOLATI VARI MODELLI	3308555M91	
04084	55	400	Silenziatore corto altezza cofano/ Short silencer hood height - Fascet- ta/Clamp ama code 03394		4830, 5500, 5500/R, 5830, 5830/R, 6500, 6500/DT, 6500/R, 6550/DT, 6550/R, 6830, 6830/DT, 7500/DT, 7550/ DT, 7830, 7830/DT, 8500/DT, 8550/DT, 8830/DT	894291M2	
04085	55	300	Silenziatore corto altezza cofano - Short silencer hood height Fascetta - Clamp Art. 03394		LANDINI MASSEY FERGUSON		
04088	65	1110	Flangia triangolare interasse 74 mm - Triangular flange 64 mm hole distance		8000 - 9500	1432713M91, 898228M92	
04089	40	750	Flangia triangolare interasse 64 mm - Triangular flange 64 mm hole distance		3000 - 3500	1817867M91	
04090	55	1140	Fascetta - Clamp Art. 03394/ Collier Art.03394		5830, 5860, 5870, 6070, 6870, 6880, 7550, 7830, 7860, 7870, 7880, 8830, 8860, 8870, 8880, ADVANTAGE CAB: 60, ADVAN- TAGE F.S.: 65, ADVANTAGE F.S.: 75, ADVANTAGE F.S.: 55, ADVANTAGE F.S.: 60, BLIZZARD: 50, BLIZZARD: 60, BLIZZARD: 65, BLIZZARD: 75, BLIZZARD: 85, CINGOLATI: CF6030, CINGO- LATI: C6830, CINGOLATI: CF5030, CINGOLATI: CF6830, FRUTTETI 530 F/L/V: 4530, FRUTTETI 530 F/L/V: 5530, FRUTTETI 530 F/L/V: 6530, FRUTTETI 530 F/L/V: 7530, FRUTTETI 530 F/L/V: 8530, FRUT- TETI 560 F/L/V: 5560, FRUTTETI 560 F/L/V: 6060, FRUTTETI 560 F/L/V: 6560, FRUTTETI 560 F/L/V: 7560, FRUTTETI 560 F/L/V: 8560, NEW SERIE 60: 5860, NEW SERIE 60: 7860, NEW SERIE 60: 8860, SERIE 80, VIGNETI CAB E F.S.: 60V	3530335M91	
04091	50	1040	Fascetta/Clamp ama code 03382/ Collier Art.03382		ADATTABILE A VARI MODELLI	1683796M3	



Art./Ref.	Ø Attacco mm/ Attack Ø mm	Altezza mm/ Height mm	Note/Note	Brand	Applicazione/Application	Rif. Orig./Orig. Ref.	Immagine/Image
04828	54	1130	Fascetta/Clamp ama code 03394	LANDINI	4830, 5500, 5500/R, 6330/DT, 6500, 6500/R, 6550/R, 6830, 7330, 7500/DT, 7550/DT, 7830/DT, 8500/DT, 8550/DT, 8830/DT, FRUTTETI 530 F/L/V: 4530,PRIMA, FRUTTETI 530 F/L/V: 5530,PRIMA, FRUTTETI 530 F/L/V: 6530,PRIMA, FRUTTETI 530 F/L/V: 7530,PRIMA, FRUTTETI 530 F/L/V: 8530,PRIMA	1427799M94	
03397	26	160	Flangia a 2 fori interasse 54 mm/ 2 holes flange 54 mm holes distance	LOMBARDINI	503, 520, 522, 530, 6 LD 325, 6 LD 360, LDA 500	5462.089, 5462089	
03398	28	120	Flangia a 2 fori asolati interasse 62 mm/ 2 eyed holes flange 62 mm holes distance		3 LD 510, 4 LD 705, LDA 100, LDA 450, LDA 510, LDA 80, LDA 820, LDA 96, LDA 97	5460.090, 5460090	
03399	28	120	Flangia a 2 fori interasse 56 mm - 2 hole flange 56 mm hole distance		3 LD 490, IM490, LDA 400	5460.048, 5460048	
03400	24	150	Flangia a 2 fori interasse 47 mm/ 2 holes flange 47 mm holes distance		IM 300, IM350, LA300, LA350	5460-394	
03460	28	120	Flangia a 2 fori interasse 45 mm - 2 hole flange 45 mm hole distance		C.M. 80, C.M. 90	-	
04036	46	390	Flangia a 2 fori interasse 70 mm - 2 hole flange 70 mm hole distance Codice 04037 Curva per Art. - Bending for part nr 04036 Ref. Lomb. 9170-028 Fascetta - Clamp Art. 02612		100, 24 LD 640, 5 LD 675, 672, 832, 904, 914 LDA, 96, 97	5461-047	
04059	46	720	Fascetta - Clamp Art. 02612/ Collier art. 02612/		MASSEY FERGUSON	200 - 244	0973083
04060	70	1340	Fascetta - Clamp Art. 04052/ Collier art. 04052/	592, 595, 698 298		1612260, 1612260M91, 3600200M91	

Art./Ref.	Ø Attacco mm/ Attack Ø mm	Altezza mm/ Height mm	Note/Note	Brand	Applicazione/Application	Rif. Orig./Orig. Ref.	Immagine/Image
<b>04068</b>	46	530	Flangia triangolare a 3 fori interasse 75 mm - 3 hole triangular flange 75 mm hole distance	<b>MASSEY FERGUSON</b>	MF 274 CF, MF 367 CF, MF 376 CF, MF 376 XCF, MF 396 CF	3308555M91	
<b>04086</b>	55	1070	Fascetta - Clamp Art. 03394/Collier Art.03394		265, 275, 285, 290, 560, 575, 590, 675 DT, 690	1672994M93, 1699143M92	
<b>04087</b>	55	1385	Fascetta - Clamp Art. 03394/Collier Art.03394		265, 275, 290, 382, 575, 590 FUORI COFANO, DT362	1673835M92, 1675390M92, 3772138M1, 699143M91	
<b>04091</b>	50	1040	Fascetta/Clamp ama code 03382/ Collier Art.03382		MF 135, MF 140, MF 148, MF 152, MF 35, MF 550	894291M4	
<b>04828</b>	54	1130	Fascetta/Clamp ama code 03394		133/R, 134/C, 135/R, 154/C, 174/C, 194/C, 234/C, 235/R, 240/R, 245/R, 245DT, 254/C, 254/DT, 274/C, 274/DT, 294/C	1427799M94, 894291M2	
<b>03393</b>	32	130	Flangia a 2 fori interasse 53 mm / 2 hole flange 53 mm hole distance	<b>MINARELLI</b>	1190	-	
<b>03457</b>	30	95	Flangia a 2 fori interasse 53 mm / 2 hole flange 53 mm hole distance		PER MOTOZAPPA BENASSI MOD.BL75	-	
<b>04828</b>	54	1130	Fascetta/Clamp ama code 03394	<b>RENAULT</b>	551/45, 651/S, HP 91/DT	-	
<b>12078</b>	30	150	Flangia a 2 fori interasse 65 mm / 2 hole flange 65 mm hole distance	<b>RUGGERINI</b>	RF 80, RF 90	527-44	

Art./Ref.	Ø Attacco mm/ Attack Ø mm	Altezza mm/ Height mm	Note/Note	Brand	Applicazione/Application	Rif. Orig./Orig. Ref.	Immagine/Image
04098	50	1170	Fascetta - Clamp Art. 03394/Collier Art.03394	SAME	TRATTORI VARI SAME	-	
04099	54	1120	Fascetta - Clamp Art. 03394/Collier Art.03394		TRATTORI VARI SAME	-	
04100	65	1050	Fascetta - Clamp Art. 03387/Collier Art.03387		TRATTORI VARI SAME	-	
09857	65	620	Tipo corto - Short type Fascetta - Clamp Art. 03387		TRATTORI VARI SAME	-	
09858	75	850	Tipo lungo - Long type		TRATTORI VARI SAME	-	

Art./Ref.	Ø Attacco mm/ Attack Ø mm	Altezza mm/ Height mm	Note/Note	Brand	A mm	B mm	Applicazione/ Application	Rif. Orig./ Orig. Ref.	Immagine/Image
04061	60	850	Flangia a 2 fori interasse 72 mm/ 2 holes flange 72 mm holes distance	STEYR	-	-	T80	80540048	
04062	46	910	Flangia quadra a 4 fori interasse 60 mm - 4 hole square flange 60 mm hole distance		-	-	8060, 8070, 8080, 8090	31100110011, 33700540154, 33700540159, 35700540007	
04095	47	1160	Flangia triangolare a 3 fori interasse 74 mm - 3 hole triangular flange 74 mm hole distance		-	-	430, 540, 545, 548, 650, 658, 748, 760	192540091	
52739	-	-	-		475	80	T188 - 188N	188540122	
52752	-	-	-		450	45	TRATTORI VARI STEYR	33700540701	

**KIT SILENZIATORI QUADRI ADATTABILI FIAT**
*SILENCIEUX KIT PANNEAU ADAPTABLES FIAT*
*SILENCERS KIT PANEL ADAPTABLES FIAT*
*SILENCER KIT PANEL PASSEND ZU FIAT*
*ESCAPE KIT PANEL ADAPTABLE FIAT*

Art./Ref.	Note/Note	Pos.
84444	Kit composto da : 04144 Silenziatore quadro adattabile Fiat 5157240 - 04056 Prolunga curva adattabile Fiat 4997329 - 03382 Collare CPT adattabile Fiat 5117613 / Kit Silencer consists of : 04144 Silencer square adaptable Fiat 5157240 - 04056 Curved extension adaptable Fiat 4997329 - 03382 Muffler camp adaptable Fiat 5117613	1
85444	Kit composto da : 04144 Silenziatore quadro adattabile Fiat 5157240 - 04057 Prolunga dritta adattabile Fiat 44905154 - 03382 Collare CPT adattabile Fiat 5117613 / Kit Silencer consists of : 04144 Silencer square adaptable Fiat 5157240 - 04057 Straight extension adaptable Fiat 44905154 - 03382 Muffler camp adaptable Fiat 5117613	2
85496	Kit composto da : 03363 Silenziatore quadro adattabile Fiat 5152184 - 04074 Prolunga dritta adattabile Fiat 44905774 - 03387 Collare CPT adattabile Fiat 5116800 / Kit Silencer consists of : 03363 Silencer square adaptable Fiat 5152184 - 04074 Straight extension adaptable Fiat 44905774 - 03387 Muffler camp adaptable Fiat 5116800	2
85497	Kit composto da : 03363 Silenziatore quadro adattabile Fiat 5152184 - 04072 Prolunga curva adattabile Fiat 5100923 - 03387 Collare CPT adattabile Fiat 5116800 / Kit Silencer consists of : 03363 Silencer square adaptable Fiat 5152184 - 04072 Curved extension adaptable Fiat 5100923 - 03387 Muffler camp adaptable Fiat 5116800	3
85498	Kit composto da : 03363 Silenziatore quadro adattabile Fiat 5152184 - 04073 Prolunga curva adattabile Fiat 4997486 - 03387 Collare CPT adattabile Fiat 5116800 / Kit Silencer consists of : 03363 Silencer square adaptable Fiat 5152184 - 04073 Curved extension adaptable Fiat 4997486 - 03387 Muffler camp adaptable Fiat 5116800	3

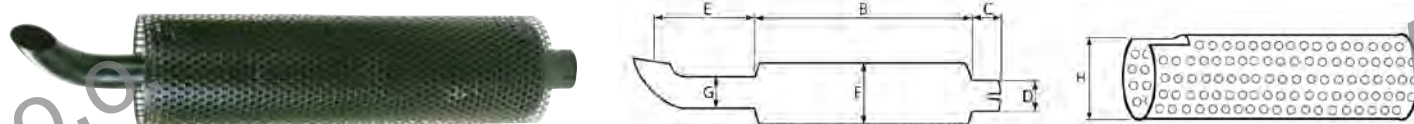
**SILENZIATORI SUPERSILENZIATI COMPLETI DI RETE ANTISCOTTATURE**
*SILENCIEUX COMPLETS DE GRILLE DE PROTECTION*
*SILENCERS WITH BURNING-SAFE GRILL*
*AUSPUFFE ""SEHR LEISE"" MIT BRANDSCHUTZ*
*SILENCIADORES SUPARSILENCIADOS COMPLETOS CON RED ANTIQUEMADURA*

**Note:** Caratteristiche : Questi silenzianti sono dotati di un doppio sistema di silenziamento il quale riduce la rumorosità di oltre 20 dB, facendo rientrare tale valore nei limiti consentiti dalle normative CEE. Inoltre sono forniti completi di rete antiscottatura previste dalle vigenti norme "USL". Tali caratteristiche li rendono conformi alle norme CEE e ne permettono quindi l'applicazione anche nel primo impianto poiché sono omologabili.

**Notes:** Characteristics : These silencers are equipped with a double silencing system, reducing noise level by more than 20dB & making them up to the EU norms. They are supplied with protection net, as per "USL" norms. These features allows them to be up to CEE norms. They can, therefore, be used by OEM & be homologated.

Art./Ref.	Note/Note	B mm	C mm	D mm	E mm	F mm	G mm	Potenza motore/ Engine power	Diametro Protezione mm/ Protection diameter mm
05327	Potenza 20 Hp del motore - 20 Hp engine motor	400	60	40	130	100	45	20	120
05328	Potenza 35 Hp del motore - 35 Hp engine motor	500	60	46	130	100	45	35	120
05329	Potenza 45 Hp del motore - 45 Hp engine motor	550	60	46	130	100	45	45	120
05330	Potenza 55 Hp del motore - 55 Hp engine motor	600	60	250	130	100	45	55	120
05331	Potenza 60 Hp del motore - 60 Hp engine motor	600	60	55	130	100	45	60	120
05332	Potenza 65 Hp del motore - 65 Hp engine motor	650	60	55	130	100	45	65	120
05333	Potenza 70 Hp del motore - 70 Hp engine motor	750	60	55	200	120	48	70	140
05334	Potenza 70 Hp del motore - 70 Hp engine motor	850	60	55	200	120	48	70	140
05335	Potenza 80 Hp del motore - 80 Hp engine motor	950	60	60	200	120	60	80	140
05336	Potenza 80 Hp del motore - 80 Hp engine motor	1000	60	70	200	120	60	80	140
05337	Potenza 80 Hp del motore - 80 Hp engine motor	600	60	60	200	150	60	80	170
05338	Potenza 90 Hp del motore - 90 Hp engine motor	900	60	60	200	150	60	90	170
05339	Potenza 110 Hp del motore - 110 Hp engine motor	1000	80	80	200	150	70	110	170
05340	Potenza 120 Hp del motore - 120 Hp engine motor	700	80	70	200	180	60	120	200
05341	Potenza 130 Hp del motore - 130 Hp engine motor	1000	80	80	200	180	70	130	200
05342	Potenza 130 Hp del motore - 130 Hp engine motor	700	80	76	200	200	80	130	220
05343	Potenza 150 Hp del motore - 150 Hp engine motor	800	80	80	200	230	80	150	250
05344	Potenza 200 Hp del motore - 200 Hp engine motor	1000	80	85	200	230	90	200	250

**MARMITTE IN ACCIAIO AL TITANIO RIVESTITE IN ALLUMINIO TIPO DRITTO PICCOLE**

POT D'ÉCHAPPEMENT EN TITANE COFFRÉ EN ALUMINIUM TYPE DROIT PETIT

STEEL MUFFLER IN TITANIUM COATED IN ALUMINIUM STRAIGHT TYPE SMALL

HNUSPUFFTOPF AUS TITANSTAHL ÜBERZOGEN AUS ALUMINIUM GERADER TYP SMALL

TUBO ED ESCAPE EN ACERO AL TITANIO CUBIERTAS EN ALUMINIO TIPO RECTO PEQUEÑO



**Note:** Costruite con speciali acciai al titanio con rivestimento in alluminio. Stampate e aggraffate meccanicamente. Eliminazione delle saldature garantendo maggiore durezza e robustezza. Abbattimento sonoro con elevati rendimenti

**Notes:** Built with special titanium steels with aluminium covering. Mechanically printed and seamed. Higher hardness and strength guaranteed through the elimination of the welding. Knock down of noise with high efficiency

Art./Ref.	Ø Attacco mm/Attack Ø mm	Potenza motore/Engine power	H mm	Note/Note
84334	40	50-65	970	Marmitta tubo dritto fascette - Muffler straight pipe clamps diam. 40 mm
59789	45	50-65	970	Marmitta tubo dritto fascette - Muffler straight pipe clamps diam. 45 mm
84336	50	60-75	970	Marmitta tubo dritto fascette - Muffler straight pipe clamps diam. 50 mm
84337	55	70-85	1085	Marmitta tubo dritto fascette - Muffler straight pipe clamps diam. 55 mm
84338	60	85-120	1085	Marmitta tubo dritto fascette - Muffler straight pipe clamps diam. 60 mm
84339	65	110-130	1085	Marmitta tubo dritto fascette - Muffler straight pipe clamps diam. 65 mm
84342	70	130-150	1085	Marmitta tubo dritto fascette - Muffler straight pipe clamps diam. 70 mm

**MARMITTE IN ACCIAIO AL TITANIO RIVESTITE IN ALLUMINIO TIPO DRITTO**

POT D'ÉCHAPPEMENT EN TITANE COFFRÉ EN ALUMINIUM TYPE DROIT

STEEL MUFFLER IN TITANIUM COATED IN ALUMINIUM STRAIGHT

HNUSPUFFTOPF AUS TITANSTAHL ÜBERZOGEN AUS ALUMINIUM GERADER

TUBO ED ESCAPE EN ACERO AL TITANIO CUBIERTAS EN ALUMINIO TIPO RECTO



**Note:** Costruite con speciali acciai al titanio con rivestimento in alluminio. Stampate e aggraffate meccanicamente. Eliminazione delle saldature garantendo maggiore durezza e robustezza. Abbattimento sonoro con elevati rendimenti

**Notes:** Characteristics: Built with special titanium steels with aluminum covering. Mechanically printed and seamed. Higher hardness and strength guaranteed through the elimination of the welding. Knock down of noise with high efficiency.

Art./Ref.	Ø Attacco mm/Attack Ø mm	Potenza motore/Engine power	H mm	Note/Note
59788	45	60-72	1180	Marmitta tubo dritto fascette - Muffler straight pipe clamps diam. 45 mm
59790	50	65-75	1180	Marmitta tubo dritto fascette - Muffler straight pipe clamps diam. 50 mm
84343	55	70-85	1180	Marmitta tubo dritto fascette - Muffler straight pipe clamps diam. 55 mm
59787	60	85-120	1320	Marmitta tubo dritto fascette - Muffler straight pipe clamps diam. 60 mm
84354	65	110-130	1320	Marmitta tubo dritto fascette - Muffler straight pipe clamps diam. 65 mm
84355	70	130-150	1320	Marmitta tubo dritto fascette - Muffler straight pipe clamps diam. 70 mm

**MARMITTE IN ACCIAIO AL TITANIO RIVESTITE IN ALLUMINIO TIPO CURVO PICCOLE**

POT D'ÉCHAPPEMENT EN TITANE COFFRÉ EN ALUMINIUM TYPE COURBE PETIT  
 STEEL MUFFLER IN TITANIUM COATED IN ALUMINIUM CURVED TYPE SMALL  
 HNUSPUFFTOPF AUS TITANSTAHL ÜBERZOGEN AUS ALUMINIUM GEKRÜMMTER TYP SMALL  
 TUBO ED ESCAPE EN ACERO AL TITANIO CUBIERTAS EN ALUMINIO TIPO CURVO PEQUEÑO



**Note:** Costruite con speciali acciai al titanio con rivestimento in alluminio. Stampate e aggraffate meccanicamente. Eliminazione delle saldature garantendo maggiore durezza e robustezza. Abbattimento sonoro con elevati rendimenti

**Notes:** Built with special titanium steels with aluminium covering. Mechanically printed and seamed. Higher hardness and strength guaranteed through the elimination of the welding. Knock down of noise with high efficiency

Art./Ref.	Ø Attacco mm/Attack Ø mm	Potenza motore/Engine power	H mm	Note/Note
84344	40	50-65	1025	Marmitta tubo curvo fascette - Muffler curved pipe clamps diam. 40 mm
84352	45	50-65	1025	Marmitta tubo curvo fascette - Muffler curved pipe clamps diam. 45 mm
84353	50	60-75	1025	Marmitta tubo curvo fascette - Muffler curved pipe clamps diam. 50 mm
84356	55	70-85	1140	Marmitta tubo curvo fascette - Muffler curved pipe clamps diam. 55 mm
84357	60	85-120	1140	Marmitta tubo curvo fascette - Muffler curved pipe clamps diam. 60 mm
84358	65	110-130	1140	Marmitta tubo curvo fascette - Muffler curved pipe clamps diam. 65 mm
84359	70	130-150	1140	Marmitta tubo curvo fascette - Muffler curved pipe clamps diam. 70 mm

**MARMITTE IN ACCIAIO AL TITANIO RIVESTITE IN ALLUMINIO TIPO CURVO**

POT D'ÉCHAPPEMENT EN TITANE COFFRÉ EN ALUMINIUM TYPE COURBE  
 STEEL MUFFLER IN TITANIUM COATED IN ALUMINIUM CURVED  
 HNUSPUFFTOPF AUS TITANSTAHL ÜBERZOGEN AUS ALUMINIUM GEKRÜMMTER TYP  
 TUBO ED ESCAPE EN ACERO AL TITANIO CUBIERTAS EN ALUMINIO TIPO CURVO



**Note:** Costruite con speciali acciai al titanio con rivestimento in alluminio. Stampate e aggraffate meccanicamente. Eliminazione delle saldature garantendo maggiore durezza e robustezza. Abbattimento sonoro con elevati rendimenti

**Notes:** Built with special titanium steels with aluminium covering. Mechanically printed and seamed. Higher hardness and strength guaranteed through the elimination of the welding. Knock down of noise with high efficiency

Art./Ref.	Ø Attacco mm/Attack Ø mm	Potenza motore/Engine power	H mm	Note/Note
84388	45	60-72	1235	Marmitta tubo curvo fascette - Muffler curved pipe clamps diam. 45 mm
84389	50	65-75	1235	Marmitta tubo curvo fascette - Muffler curved pipe clamps diam. 50 mm
84390	55	70-85	1235	Marmitta tubo curvo fascette - Muffler curved pipe clamps diam. 55 mm
84391	60	85-120	1400	Marmitta tubo curvo fascette - Muffler curved pipe clamps diam. 60 mm
84392	65	110-130	1400	Marmitta tubo curvo fascette - Muffler curved pipe clamps diam. 65 mm
84393	70	130-150	1400	Marmitta tubo curvo fascette - Muffler curved pipe clamps diam. 70 mm

**COLLETTORI SCARICO PER MOTORI ADATTABILI FIAT**

COLLECTEURS D'ÉCHAPPEMENT MOTEURS ADAPTABLE FIAT  
 REAR MUFFLER COLLECTOR ADAPTABLE FIAT  
 AUSPUFFSAMMLER PASSEND ZU FIAT MOTOREN  
 COLECTORES DE ESCAPE PARA MOTORES ADAPTABLE FIAT



Art./Ref.	Brand	Applicazione/Application	Rif. Orig./Orig. Ref.
10516	FIAT	350, 40, 420, 440, 446, 45.66, 450, 455, 465, 470, 474, 480, 50, 500, 505C, 540, 55, 55.46, 55.66, 565, 566, 60, 60.65, 60.66, 80.46, 80.50, 80.56, 80.60	4607842, 4768783

**GUARNIZIONI COLLETTORE SCARICO PER MOTORI ADATTABILI FIAT**

JOINT COLLECTEUR ÉCHAPPEMENT POUR MOTEUR ADAPTABLE FIAT  
 COLLECTOR GASKETS ADAPTABLE FIAT ENGINES  
 DICHTUNGEN KOLLEKTORAUSPUFF FEUR PASSEND ZU FIAT MOTOREN  
 GUARNICIONES COLECTOR DE ESCAPE PARA MOTORES ADAPTABLE FIAT



Art./Ref.	Brand	Applicazione/Application	Rif. Orig./Orig. Ref.
10515	FIAT	TUTTI I MODELLI	4601981, 4813566, 4849327, 98428397, 98489690

**COLLETTORI SCARICO PER MOTORI ADATTABILI FIAT**

COLLECTEURS D'ÉCHAPPEMENT MOTEURS ADAPTABLE FIAT  
 REAR MUFFLER COLLECTOR ADAPTABLE FIAT  
 AUSPUFFSAMMLER PASSEND ZU FIAT MOTOREN  
 COLECTORES DE ESCAPE PARA MOTORES ADAPTABLE FIAT



Art./Ref.	Brand	Applicazione/Application	Rif. Orig./Orig. Ref.
10517	FIAT	605C, 640, 65, 65.46, 65.66, 665, 666, 70, 70.65, 765, 766, 80, 80.65, 80.66, 80.70, 80.76, 85.55	4606570

**GUARNIZIONI GOMITO SCARICO PER MOTORI ADATTABILI FIAT**

JOINT COURBE ÉCHAPPEMENT POUR MOTEUR ADAPTABLE FIAT  
 GASKETS FOR EXHAUSTING ELBOW PIPE ADAPTABLE FIAT ENGINES  
 DICHTUNGEN BOGEN AUSPUFF PASSEND ZU FIAT MOTOREN  
 GUARNICIONES CODO DE ESCAPE PARA MOTORES ADAPTABLE FIAT



Art./Ref.	Brand	Applicazione/Application	Rif. Orig./Orig. Ref.	Note/Note
10675	FIAT	300, 350, 400, 450, 500, 540, 550, 580, 600, 650	4610742, 5118183, 5152380	Tipo / Type: Guarnizione Rif. 5152380 / Sealing Ref. 5152380

**COLLETTORI A GOMITO DI SCARICO ADATTABILI FIAT**

COLLECTEURS D'ÉCHAPPEMENT MOTEURS ADAPTABLE FIAT  
 REAR MUFFLER COLLECTOR ADAPTABLE FIAT  
 AUSPUFFSAMMLER PASSEND ZU FIAT-MOTOREN  
 COLECTORES DE ESCAPE PARA MOTORES ADAPTABLE FIAT



Art./Ref.	Brand	Applicazione/Application	Rif. Orig./Orig. Ref.	Note/Note
<b>04079</b>	<b>FIAT</b>	45.66, 465, 55.65, 55.66, 60.65, SERIE 66	44905487, 5128108, 5164290	Utilizzabile con silenziatore / Suitable for silencer part ama code 04055

**COLLETTORI A GOMITO DI SCARICO PER MOTORI ADATTABILI FIAT**

COLLECTEURS D'ÉCHAPPEMENT MOTEURS ADAPTABLE FIAT  
 REAR MUFFLER COLLECTOR ADAPTABLE FIAT  
 AUSPUFFSAMMLER PASSEND ZU FIAT MOTOREN  
 COLECTORES DE ESCAPE PARA MOTORES ADAPTABLE FIAT



Art./Ref.	Brand	Applicazione/Application	Rif. Orig./Orig. Ref.	Note/Note
<b>04082</b>	<b>FIAT</b>	446, 466, 55.46, 566, 60.66, 65.46, 65.66, 666, 70.66, 766, 80.66, SERIE 66	44905153, 5121925, 5164163	Curvato ad "U" inclinato in avanti - "U" shaped forward inclined

**COLLETTORI A GOMITO DI SCARICO PER MOTORI ADATTABILI FIAT**

COLLECTEURS D'ÉCHAPPEMENT MOTEURS ADAPTABLE FIAT  
 REAR MUFFLER COLLECTOR ADAPTABLE FIAT  
 AUSPUFFSAMMLER PASSEND ZU FIAT MOTOREN  
 COLECTORES DE ESCAPE PARA MOTORES ADAPTABLE FIAT



Art./Ref.	Brand	Applicazione/Application	Rif. Orig./Orig. Ref.	Note/Note
<b>04083</b>	<b>FIAT</b>	45.66, 465, 55.65, 55.66, 60.65, SERIE 66	5104820, 5151556, 5164167	Inclinato in avanti, tipo lungo doppia curva - Forward inclined long type double bending

**COLLETTORI A GOMITO DI SCARICO PER MOTORI ADATTABILI FIAT**

COLLECTEURS D'ÉCHAPPEMENT MOTEURS ADAPTABLE FIAT  
 REAR MUFFLER COLLECTOR ADAPTABLE FIAT  
 AUSPUFFSAMMLER PASSEND ZU FIAT MOTOREN  
 COLECTORES DE ESCAPE PARA MOTORES ADAPTABLE FIAT



Art./Ref.	Brand	Applicazione/Application	Rif. Orig./Orig. Ref.	Note/Note
<b>06218</b>	<b>FIAT</b>	420, 440, 450, 455, 480, 500, 505, 540, 605, 640	4981674, 5011655, 5102917, 598592	Gomito scarico cingolati e trattori - Delivery elbow track e tractors
<b>14398</b>		850	44011746, 4998652	Gomito scarico cingolati e trattori - Delivery elbow track e tractors



**COLLETTORI A GOMITO DI SCARICO ADATTABILI PER MOTORI FIAT**

COLLECTEURS D'ÉCHAPPEMENT ADAPTABLE MOTEURS FIAT  
 REAR MUFFLER COLLECTOR ADAPTABLE FOR FIAT  
 AUSPUFFSAMMLER PASSEND ZU FIAT MOTOREN  
 COLECTORES DE ESCAPE ADAPTABLE PARA MOTORES FIAT



Art./Ref.	Brand	Applicazione/Application	Rif. Orig./Orig. Ref.	Note/Note
06261	FIAT	DALLA SERIE 250 ALLA SERIE 670	5101206, 5109917, 598350	Gomito curvato ad "U" - "U" Shaped elbow/Collecteur 'U'

**COLLETTORI A GOMITO DI SCARICO ADATTABILI FIAT**

COLLECTEURS D'ÉCHAPPEMENT MOTEURS ADAPTABLE FIAT  
 REAR MUFFLER COLLECTOR ADAPTABLE FIAT  
 AUSPUFFSAMMLER PASSEND ZU FIAT-MOTOREN  
 COLECTORES DE ESCAPE PARA MOTORES ADAPTABLE FIAT



Art./Ref.	Brand	Applicazione/Application	Rif. Orig./Orig. Ref.	Note/Note
04081	FIAT	70.66, 70.66S, 80.66, 80.66S	5135419, 5156501, 5160813	Gomito in ghisa curvato ad "U" - Cast iron elbow "U" Shaped

**COLLETTORI A GOMITO DI SCARICO ADATTABILI LANDINI**

COLLECTEURS D'ÉCHAPPEMENT MOTEURS ADAPTABLE LANDINI  
 REAR MUFFLER COLLECTOR ADAPTABLE LANDINI  
 AUSPUFFSAMMLER PASSEND ZU LANDINI-MOTOREN  
 COLECTORES DE ESCAPE PARA MOTORES ADAPTABLE LANDINI



Art./Ref.	Brand	Applicazione/Application	Note/Note
02148	LANDINI	CINGOLATI	Collettore a gomito prolungato - Elbow long manifold

**ADATTATORE DA MARMITTA FIAT A LANDINI**

ADAPTATEUR POUR ECHAPPEMENTS FIAT ET LANDINI  
 MUFFLER ADAPTOR FOR FIAT AND LANDINI  
 AUSPUFFADAPTER FIAT-LANDINI TRAKTORE  
 ADAPTADOR DE TUBO DE ESCAPE FIAT A LANDINI



Art./Ref.	A mm	B mm	Note/Note
<b>05676</b>	46	56	Riduzione marmitta Fiat/Landini / Reduction muffler Fiat/Landini

**TUBO SCAR.SOTTOCARRO ADATTABILE FIAT 44905168**

POT D'ECHAPPEMENT ADAPTABLE POUR FIAT 44905168  
 INFERIOR DISCHARGE HOSE ADAPTABLE TO FIAT 44905168  
 NIEDRIGES AUSSTOSSROHR PASSEND ZU FIAT 44905168  
 TUBO SCAR.SOTTOCARRO ADAPTABLE PARA FIAT 44905168



Art./Ref.	Ø Attacco mm/ Attack Ø mm	Brand	Applicazione/Application	Rif. Orig./Orig. Ref.	Note/Note
<b>04077</b>	45	<b>FIAT</b>	1300, 350, 420, 446, 450, 480, 500, 540, 55.46, 640, 65.46	44905168, 4953808, 4956043, 4956048, 4958669, 4959046, 4964092, 4981677, 4982305, 4984214, 5011635, 5011641, 5011845, 5101806, 598314, 598348, 598354	Tipo/ Type: Tubo scarico sottocarro Rif. 44905168 / Inferior discharge hose Ref. 44905168

**FLANGE PER TUBO SOTTOCARRO ADATTABILE FIAT**

FLASQUES POUR POT D'ECHAPPEMENT INFERIEUR ADAPTABLE FIAT  
 FLANGES FOR INFERIOR HOSE ADAPTABLE TO FIAT  
 FLANSCHEN FUER NIEDRIGES ROHR PASSEND ZU FIAT  
 COLLARES PARA TUBO INFERIOR ADAPTABLE FIAT



Art./Ref.	Brand	Applicazione/Application	Rif. Orig./Orig. Ref.	Note/Note
<b>04070</b>	<b>FIAT</b>	DAL 250 AL 670	44905167, 5011638, 596647	Tubo sottocarro - Bottom pipe Art. 04077
<b>04071</b>		OM DAL 650 AL 1000	596752	Tubo sottocarro - Bottom pipe Art. 04077

## GRIGLIE METALLICHE ANTISCOTTATURE

GRILLES DE PROTECTION

METAL BURNING-SAFE GRILL

BRANDSHUTZ FÜR AUSPUFF

CRIBAS METÁLICAS ANTIQUEMADURAS

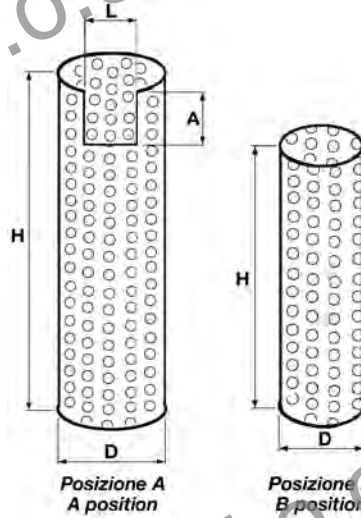

**Note:** Caratteristiche : Complete di 4 bulloni per il fissaggio. Pronte al montaggio e di facile installazione, rispondono alle normative "CEE" ed alle esigenze di sicurezza "USL". Applicabili e adattabili su tutti i tipi silenziosi e su marmitte e prolunghe montate di serie sui motori FIAT.

**TIPO A :** per marmitte con uscita curva.

**TIPO B :** per marmitte con uscita dritta o per prolunghe.

**N.B.** Gli articoli 05044 e 05045 sono formati da entrambi i modelli di rete (A+B) ricavati in un unico pezzo, per questo sono applicabili a silenziosi completi di prolunga ma esclusivamente dritta, per permettere alla rete di essere infilata dall'alto nel silenzioso stesso, e successivamente bloccata.

**Notes:** Characteristics : Supplied with 4 bolts for fixing. Ready for fixing & easy to install, they are up to "CEE" norms & safety norms by "USL". Suitable and adaptable for all sort of silencers & for exhausts + extensions fixed on FIAT engines from factory.

**TYPE A :** for silencers with bended outlet.

**TYPE B :** for silencers with straight outlet or extensions.

**N.B.** Part. n. 05044 & 05045, are made of both net models (A+B). They are made of 1 single pc. That is why they can be fixed on silencer with straight extension only, to allow the net to be lowered around the silencer from above & be fixed afterward.

Art./Ref.	Pos.	D mm	H mm	Note/Note	Applicazione/Application
05040	B	125	350	-	ART. 04828-04085-04846
05041	B	125	500	-	ART. 03404-04059-04054
05042	A	125	800	LxA 90 x 90 mm	ART. 04144-04147-03402
05043	A	140	900	LxA 100 x 100 mm	ART. 03363-04086
05044	A + B	68 Pos. B - 125 Pos. A	600 Pos. B - 800 Pos. A	LxA 90 x 90 mm	ART. 04144-04147 + PROL 04057
05045	A + B	78 Pos. B - 140 Pos. A	600 Pos. B - 900 Pos. A	LxA 100 x 100 mm	ART. 03363 + PROLUNGA 04074
05046	B	68	320	-	ART. 03406 E PROLUNGHE D.48-50
05047	B	68	500	-	ART. 04056 E PROLUNGHE D.48-50
05048	B	68	630	-	ART. 04057 E PROLUNGHE D.48-50
05049	B	78	300	-	ART. 04072 E PROLUNGHE D.60-63
05050	B	78	500	-	ART. 04073 E PROLUNGHE D.60-63
05051	B	78	630	-	ART. 04074 E PROLUNGHE D.60-63

**COPERCHIETTI PARAPIOGGIA ADATTABILI FIAT**

COUVERCLE PARAPLUIE ADAPTABLE POUR FIAT  
PROTECTION CUP FOR SILENCER ADAPTABLE TO FIAT  
SCHUTZDECKEL FÜR AUSPUFFE PASSEND ZU FIAT  
TAPITAS GUARDALLUVIAS ADAPTABLE FIAT



Art./Ref.	Ø Attacco mm/Attack Ø mm	Note/Note	Applicazione/Application	Rif. Orig./Orig. Ref.
05618	46-50	Tipo originale a coperchietto con perno/Cover with pin	ART. 03402-03404-04054, 300, 350, 355, 455, 500, 505, 605, 80.50, 80.70, DAL 250 AL 780, SERIE 66	4953217, 5011654
05639	40-43	Tipo a bilancere con fascetta / clamp diam. 40-43 mm	ART. 04095	
05640	48-51	Tipo a bilancere con fascetta/clamp diam. 48-51 mm	TRATTORI FIAT 1580 VARIE	5116904, 5140886
05642	52-55	Tipo a bilancere con fascetta/clamp diam. 52-55 mm	VARIE	
05643	56-59	Tipo a bilancere con fascetta/clamp diam. 56-59 mm	VARIE	
05648	60-63	Tipo a bilancere con fascetta/Clamp diam. 60-63 mm	VARIE	5116898, 5123234, 5134341, 5140885
12542	76	Tipo a bilancere con fascetta / clamp diam. 76 mm	VARIE	

**COLLARI PER MARMITTA**

COLLIERS POUR POT D'ÉCHAPPEMENT  
MUFFLERS CLAMPS  
AUSPUFFSCHELLE  
ABRAZADERAS PARA TUBO DE ESCAPE



Art./Ref.	Brand	Applicazione/Application	Rif. Orig./Orig. Ref.	Note/Note
03382	FIAT	30-40-50-55-60-70, 300-350, 420-440-450-455-470-480, 45.66, 540-570-580, 55.65, 55.66, 60.65, 60.66, 640-670-680-780, 70.65, 70.66, 80.60, 80.65, 80.70	4980842, 4998798, 4998800, 5101436, 5101438, 5102706, 5117613	Tipo ad 2 pezzi - Diam. 46-49 mm - Type 2 pcs - Diam. 46-49 mm Silenziatori - Silencer 04144-03402-03404-04054-04055-04846-04091-04830 Prolunghe - Extension 03406-04056-04057
03387		80-90-100-110-115-130-140, 880-995-980-1180-1280-1380	4998799, 5101437, 5116800	Tipo ad 2 pezzi - Diam. 60-65 mm - Type 2 pcs - Diam. 60-65 mm Silenziatori - Silencer 03363-04094-04100 Prolunghe - Extension 04072-04073-04074
03394		805	-	Tipo ad 1 pezzo - Diam. 52-55 mm - Type 1 pc - Diam. 52-55 mm Silenziatori - Silencer 04084-04085-04828-04087-04090-04098-04099
04052		50-60-70	596913	Tipo ad 1 pezzo - Diam. 63-68 mm - Type 1 pc - Diam. 63-68 mm Silenziatori - Silencer 04051/Type à 1 pc. Diam.63-68mm. Silencieux 04051

**PROLUNGHE CURVATE PER MARMITTE ADATTABILI FIAT**

RALLONGEMENTS COURBES SILENCIEUX ADAPTABLE FIAT  
CURVED EXTENSION ADAPTABLE FIAT MUFFLERS  
GEBOGENE VERLÄNGERUNGEN PASSEND ZU FIAT-AUSPUFF  
ALARGADERAS CURVAS PARA TUBO DE ESCAPE ADAPTABLE FIAT

Art./Ref.	Ø Attacco mm/Attack Ø mm	H mm	Brand	Applicazione/Application	Rif. Orig./Orig. Ref.	Note/Note
03406	46	650	FIAT	40-420-440-450-480-640, DAL 250 AL 670	4980841, 5011633, 5117022	Silenziatore - Silencer Art. 03402
04056	46	700		465C, 565c, 665C, 765C, DAL 570 AL 780, SERIE 66	4997329	Silenziatore - Silencer Art. 04144
04072	60	450		DAL 850S AL 1380, SERIE 66.90	4987597, 5011668, 5100923	Silenziatore - Silencer Art. 03363
04073	60	600		850-880-980, DAL 850S AL 1380	4997486	Silenziatore - Silencer Art. 03363



**PROLUNGHE DIRITTE PER MARMITTE ADATTABILI FIAT**

RALLONGEMENTS DROITS SILENCIEUX ADAPTABLE FIAT  
 STRAIGHT EXTENSION ADAPTABLE FIAT MUFFLERS  
 RECHTE VERLÄNGERUNGEN PASSEND ZU FIAT-AUSPUFF  
 ALARGADERAS RECTAS PARA TUBO DE ESCAPE ADAPTABLE FIAT



Art./Ref.	Ø Attacco mm/ Attack Ø mm	H mm	Brand	Applicazione/Application	Rif. Orig./Orig. Ref.	Note/Note
<b>04057</b>	46	600	<b>FIAT</b>	465C, 565c, 663C, 665C, 765C, DAL 570 AL 780, SERIE 66	44905154, 5011645, 5116792, 5117292, 5122888	Silenziatore - Silencer Art. 04144
<b>04074</b>	60	750		DAL 850S AL 1380, SERIE 66.90	44905774, 5111564, 5111566, 5116797, 5123235	Silenziatore - Silencer Art. 03363

**PROLUNGHE DRITTE**

ALLONGEMENTS DROITS  
 EXTENSIONS STRAIGHT  
 EXTENSIONS STRAIGHT  
 EXTENSIONES DE RECTO

Art./Ref.	Ø Attacco mm/Attack Ø mm	H mm	Note/Note
<b>84372</b>	40	540	Prolunga dritta - Straight extension diam. 40 mm
<b>84360</b>	48	540	Prolunga dritta - Straight extension diam. 48 mm
<b>84362</b>	51	540	Prolunga dritta - Straight extension diam. 50 mm
<b>84364</b>	53	540	Prolunga dritta - Straight extension diam. 55 mm
<b>84366</b>	58	545	Prolunga dritta - Straight extension diam. 60 mm
<b>84368</b>	65	545	Prolunga dritta - Straight extension diam. 65 mm
<b>84370</b>	67	545	Prolunga dritta - Straight extension diam. 70 mm



**PROLUNGHE CURVE**

COURBES D'EXTENSION  
 EXTENSION CURVES  
 DEHNUNGSKURVEN  
 CURVAS DE EXTENSIÓN

Art./Ref.	Ø Attacco mm/Attack Ø mm	H mm	Note/Note
<b>84373</b>	40	600	Prolunga curva - Extension curve diam. 40
<b>84361</b>	48	600	Prolunga curva - Extension curve diam. 48
<b>84363</b>	51	600	Prolunga curva - Extension curve diam. 50
<b>84365</b>	53	600	Prolunga curva - Extension curve diam. 55
<b>84367</b>	58	640	Prolunga curva - Extension curve diam. 60
<b>84369</b>	65	640	Prolunga curva - Extension curve diam. 65
<b>84371</b>	67	640	Prolunga curva - Extension curve diam. 70



**FASCETTE**

BANDES  
BANDS  
BANDS  
BANDAS

Art./Ref.	Ø Attacco mm/Attack Ø mm	Note/Note
82361	43-45	Fascette / Bands 43-45 mm
82362	46-47	Fascette / Bands 46-47 mm
82364	51-52	Fascette / Bands 51-52 mm
82365	53.0	Fascette / Bands 53 mm
82366	54-55	Fascette / Bands 54-55 mm
82367	56-57	Fascette / Bands 56-57 mm
82368	58-60	Fascette / Bands 58-60 mm
82369	61-62	Fascette / Bands 61-62 mm
82370	63-65	Fascette / Bands 63-65 mm
82371	66-67	Fascette / Bands 66-67 mm
82372	68-69	Fascette / Bands 68-69 mm
82373	70-72	Fascette / Bands 70-72 mm
82374	73-76	Fascette / Bands 73-76 mm
82375	83-85	Fascette / Bands 83-85 mm
82376	86-89	Fascette / Bands 86-89 mm
82377	92-94	Fascette / Bands 92-94 mm
82378	95-98	Fascette / Bands 95-98 mm
82379	105-108	Fascette / Bands 105-108 mm
82380	109-112	Fascette / Bands 109-112 mm
82389	117-120	Fascette / Bands 117-120 mm
82381	121-123	Fascette / Bands 121-123 mm
82382	124-127	Fascette / Bands 124-127 mm
82383	128-131	Fascette / Bands 128-131 mm
82384	133-136	Fascette / Bands 133-136 mm
82385	137-140	Fascette / Bands 137-140 mm

**PARAPIOGGIA TIPO SILENZIATO**

PROTECTION PARAPLUIE TYPE SILENCIEUX  
WATER SAFE SOUND DEAD  
GERÄUSCHARMER SCHUTZ  
PARALLUVIA TIPO SILENCIADO

Art./Ref.	Ø Attacco mm/Attack Ø mm	Note/Note
82386	40	Parapioggia silenziato / Water safe sound dead Diam. 40 mm
82387	42	Parapioggia silenziato / Water safe sound dead Diam. 42 mm
82349	45	Parapioggia silenziato / Water safe sound dead Diam. 45 mm
60041	48	Parapioggia silenziato / Water safe sound dead Diam. 48 mm/
60042	50	Parapioggia silenziato / Water safe sound dead Diam. 50 mm
82350	55	Parapioggia silenziato / Water safe sound dead Diam. 55 mm
60043	60	Parapioggia silenziato / Water safe sound dead Diam. 60 mm
82351	65	Parapioggia silenziato / Water safe sound dead Diam. 65 mm
82352	70	Parapioggia silenziato / Water safe sound dead Diam. 70 mm
82353	76	Parapioggia silenziato / Water safe sound dead Diam. 76 mm
82354	80	Parapioggia silenziato / Water safe sound dead Diam. 80 mm
82355	89	Parapioggia silenziato / Water safe sound dead Diam. 89 mm
82388	100	Parapioggia silenziato / Water safe sound dead Diam. 100 mm
82356	102	Parapioggia silenziato / Water safe sound dead Diam. 102 mm
82357	110	Parapioggia silenziato / Water safe sound dead Diam. 110 mm
82358	114	Parapioggia silenziato / Water safe sound dead Diam. 114 mm
82359	121	Parapioggia silenziato / Water safe sound dead Diam. 121 mm
82360	130	Parapioggia silenziato / Water safe sound dead Diam. 130 mm



**FASCETTA A CAVALLOTTO**

PINCE A COLLIER  
CLAMP A CLAMP  
KLEMME EINE CLAMP  
ABRAZADERA



Art. Ref.	Ø Attacco mm/Attack Ø mm	Note/Note
82390	35-37	Fascetta a cavallotto - Clamp a clam diam. 35-37 mm
82391	38-39	Fascetta a cavallotto - Clamp a clam diam. 38-39 mm
82392	40-42	Fascetta a cavallotto - Clamp a clam diam. 40-42 mm
82393	43-44	Fascetta a cavallotto - Clamp a clam diam. 43-44 mm
82394	45-47	Fascetta a cavallotto - Clamp a clam diam. 45-47 mm
82395	48-50	Fascetta a cavallotto - Clamp a clam diam. 48-50 mm
82396	51-53	Fascetta a cavallotto - Clamp a clam diam. 51-53 mm
82397	54-56	Fascetta a cavallotto - Clamp a clam diam. 54-56 mm
82398	57-59	Fascetta a cavallotto - Clamp a clam diam. 57-59 mm
82399	60-62	Fascetta a cavallotto - Clamp a clam diam. 60-62 mm
82400	63-65	Fascetta a cavallotto - Clamp a clam diam. 63-65 mm
82401	66-68	Fascetta a cavallotto - Clamp a clam diam. 66-68 mm
82402	69-71	Fascetta a cavallotto - Clamp a clam diam. 69-71 mm
82403	72-75	Fascetta a cavallotto - Clamp a clam diam. 72-75 mm
82404	76-79	Fascetta a cavallotto - Clamp a clam diam. 76-79 mm
82405	80-85	Fascetta a cavallotto - Clamp a clam diam. 80-85 mm
82406	86-88	Fascetta a cavallotto - Clamp a clam diam. 86-88 mm
82407	89-91	Fascetta a cavallotto - Clamp a clam diam. 89-91 mm
82408	92-97	Fascetta a cavallotto - Clamp a clam diam. 92-97 mm
82409	98-105	Fascetta a cavallotto - Clamp a clam diam. 98-105 mm
82410	106-109	Fascetta a cavallotto - Clamp a clam diam. 106-109 mm
82411	110-117	Fascetta a cavallotto - Clamp a clam diam. 110-117 mm
84332	118-124	Fascetta a cavallotto - Clamp a clam diam. 118-124 mm
84333	128-130	Fascetta a cavallotto - Clamp a clam diam. 128-130 mm

**GRIGLIE ANTISCOTTATURA PER MARMITTE**

GRILLE DE PROTECTION  
PROTECTION GRID  
BRANDSCHUTZ  
REJILLA DE PROTECCIÓN



Art./Ref.	Note/Note
59013	Protezione Silenziatore 560x110x120/Muffler protection 560x110x120
59014	Protezione silenziatore 670x133x127/Muffler protection 670x133x127
78820	Protezione Silenziatore 720x150x190/Muffler protection 720x150x190

**TUBI FLESSIBILI IN ACCIAIO ZINCATO PER SCARICO MOTORI (ROTOLI DA 6 MT.)**
*TUYAU FLEXIBLE EN ACIER GALVANISÉ POUR DÉCHARGÉ MOTEURS (ROULEAUX DE 6 MT.)*
*FLEXIBLE PIPE IN STEEL GALVANIZED FOR UNLOADING MOTOR (ROLLS OF 6 MT.)*
*FLEXIBLES ROHR IN STAHL GALVANISIERT, UM MOTOR AUSZULADEN (ROLLS VON 6 MT.)*
*TUBO FLEXIBLE EN ACERO GALVANIZADO PARA DESCARGAR MOTOR (ROLLOS DE 6 MT.)*

**Note:** Lo spessore della regetta e' 0,5 mm. Disponibile su richiesta in materiale inox in 0,4 mm

**Notes:** The thickness is 0,5 mm. On demand it is also available in stainless steel and 0,4 mm thick.

Art./Ref.	Ø Attacco mm/Attack Ø mm	D mm	Note/Note
82337	30	35	Tubo flessibile in acciaio - Flexible pipe in steel 30x35 mm
82338	35	40	Tubo flessibile in acciaio - Flexible pipe in steel 35x40 mm
82339	40	45	Tubo flessibile in acciaio - Flexible pipe in steel 40x45 mm
61540	45	50	Tubo flessibile in acciaio - Flexible pipe in steel 45x50 mm
61541	50	55	Tubo flessibile in acciaio - Flexible pipe in steel 50x55 mm
82340	55	60	Tubo flessibile in acciaio - Flexible pipe in steel 55x60 mm
61542	60	65	Tubo flessibile in acciaio - Flexible pipe in steel 60x65 mm
82341	65	70	Tubo flessibile in acciaio - Flexible pipe in steel 65x70 mm
82342	70	75	Tubo flessibile in acciaio - Flexible pipe in steel 70x75 mm
61536	76	81	Tubo flessibile in acciaio - Flexible pipe in steel 76x81 mm
82343	80	85	Tubo flessibile in acciaio - Flexible pipe in steel 80x85 mm
82344	85	90	Tubo flessibile in acciaio - Flexible pipe in steel 85x90 mm
82345	89	94	Tubo flessibile in acciaio - Flexible pipe in steel 89x94 mm
61537	102	107	Tubo flessibile in acciaio - Flexible pipe in steel 102x107 mm
82346	114	119	Tubo flessibile in acciaio - Flexible pipe in steel 114x119 mm
82347	121	126	Tubo flessibile in acciaio - Flexible pipe in steel 121x126 mm
82348	130	135	Tubo flessibile in acciaio - Flexible pipe in steel 130x135 mm



## 1.7.8 Carrozzeria, vernici, cristalli e maniglie

Body, paints, glasses and handles



**ama**

**Ricambi & accessori per macchine agricole**

**SPARE PARTS & ACCESSORIES FOR AGRICULTURAL MACHINE**

Tutti gli articoli della presente sezione, prodotti da AMA SPA e/o da terzi per conto di AMA, sono adattabili ("non originali") alle marche indicate ai sensi di quanto previsto dal REG. CE n. 1400/2002. I diritti sui marchi citati appartengono ai legittimi proprietari e il loro uso ha l'esclusiva finalità di consentire all'utilizzatore la comparazione dei diversi prodotti.  
All items of this section, manufactured by AMA SPA and/or any third party on behalf of AMA, are adaptable ("non-original") to the brands listed under the provisions of the REG. CE n. 1400/2002. The rights on the trademarks belong to their respective owners and their usage is only aimed to allow the user to compare different products.

**COFANATURE ADATTABILI FIAT SERIE ORO**

COUVRE-CAPOT MOTEUR ADAPTABLE FIAT

ENGINE HOOD-CUP ADAPTABLE FIAT

MOTORHAUBE PASSEND ZU FIAT-SCHLEPPER

TAPA CAPO' ADAPTABLE FIAT

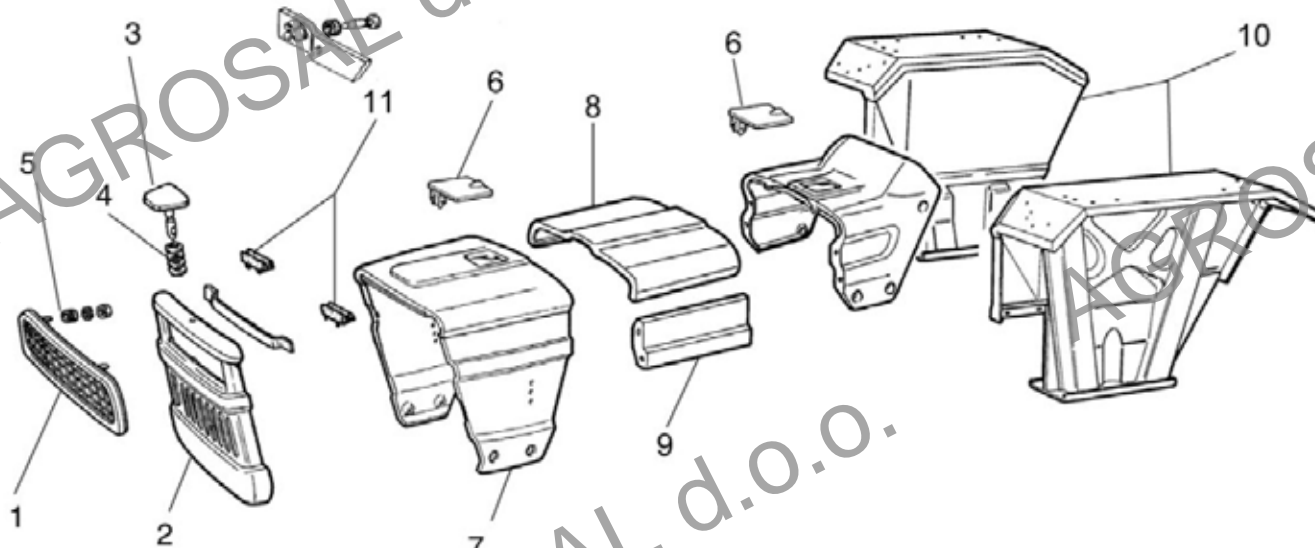

Art./Ref.	Pos.	Descrizione/Description	Brand	Applicazione/Application	Rif. Orig./Orig. Ref.
<b>01057</b>	1	Mascherina	<b>FIAT</b>	450, 480, 500, 540, 550, 605, 640, 805	4950441, 4956270, 5011646
<b>04624</b>	2	Calandra radiatore		440, 450, 480, 500, 540, 640	4950401
<b>19133</b>	3	Perno		1300R, 450DT, 450R, 640DT	4950422
<b>15816</b>	4	Molla		1000DT, 1300, 450, 605C	4950423
<b>12972</b>	5	Tassello in plastica		655C, 805C	4950442
<b>12724</b>	6	Sportellino superiore		100.90-100.90 DT, 110.90-110.90 DT, 115.90-115.90 DT, 130.90-130.90 DT, 140.90-140.90 DT, 160.90-160.90 DT, 180.90-180.90 DT, 1880DT, 35.66-35.66 DT, 45.66-45.66 DT, 45.66S-45.66S DT, 450R, 50.66-50.66 DT, 50.66S-50.66S DT, 55.90-55.90 DT, 56.66S-56.66S DT, 580DT, 60.90-60.90 DT, 640DT, 65.90-65.90 DT, 65.94-65.94 DT, 70.90-70.90 DT, 72.94-72.94 DT, 780DT, 80.90-80.90 DT, 82.94-82.94 DT, 85.90-85.90 DT, 88.94-88.94 DT, 90.90-90.90 DT, F100-F100 DT, F100.F100 DT, F110-F110 DT, F115-F115 DT, F120-F120 DT, F130-F130 DT, F140-F140 DT <b>FORD</b> 3435-3935-4135, 8430-8630-8830 <b>NEW HOLLAND</b> FD10, FD14, TK100.55, TK160.55, TK60.75, TK60.75 M, TK62.85, TK62.85 M, TK70.75, TK70.75 M, TK72.85, TK72.85 M, TK80.75, TK82.85 M, TK85.55, TK88.85 M, TK95.55	596567
<b>04627</b>	7	Cofano motore		440, 450, 480, 500, 540, 605, 640, 650, 750, 805	4953308, 599112
<b>04605</b>	8	Coperchio motore		605, 640	4950900
<b>04606</b>	9	Fianco motore destro		640	4950907
<b>04607</b>	9	Cofano motore sinistro		640	4950909
<b>04628</b>	10	Parafango posteriore destro. H=770mm		440, 450, 480, 640	4999764
<b>04629</b>	10	Parafango posteriore sinistro. H=770mm	440, 450, 480, 640	4999766	
<b>05699</b>	10	Parafango posteriore destro, assale tondo	450, 480, 500, 550, 600, 640	598847	
<b>05694</b>	10	Parafango posteriore sinistro, assale tondo	450, 480, 500, 550, 600, 640	598848	
<b>16392</b>	11	Guarnizione	655C, 805C	4954150, 599968	

**CALANDRE E GRIGLIE ADATTABILI**

CALANDRES ET GRILLES ADAPTABLE  
 FRONT GRILLS AND GRIDS ADAPTABLE  
 KALANDER UND GRIDS PASSEND ZU  
 CALANDRA COMPLETA Y ADAPTABLE

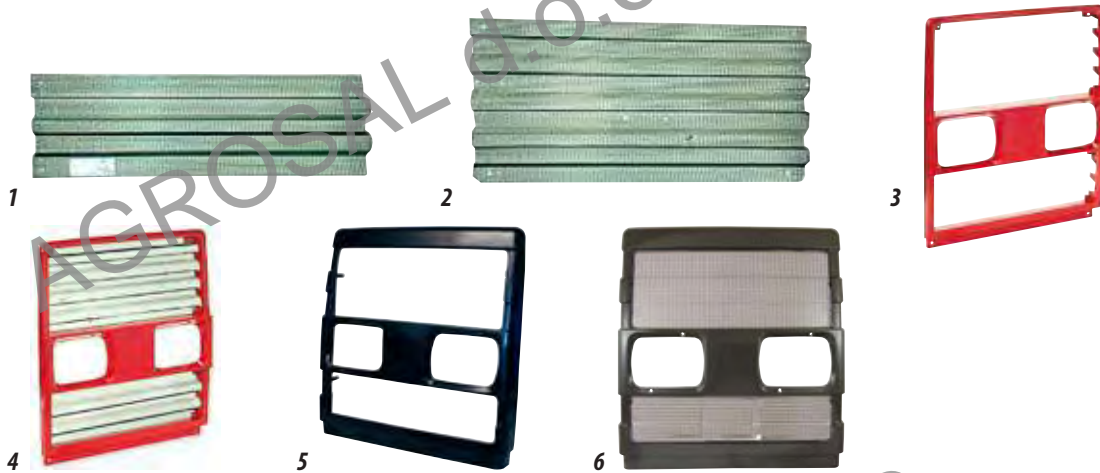

Art./Ref.	Pos.	Descrizione/Description	Brand	Applicazione/Application	Rif. Orig./Orig. Ref.
<b>17087</b>	1	Griglia inferiore	<b>FIAT</b>	100-90, 100-90DT, 110-90, 110-90DT, 55-90, 55-90DT, 60-90, 60-90DT, 65-90, 65-90DT, 70-90, 70-90DT, 80-90, 80-90DT, 85-90, 85-90DT, 90-90, 90-90DT	5119772
<b>17089</b>	2	Griglia superiore		100-90, 100-90DT, 110-90, 110-90DT, 55-90, 55-90DT, 60-90, 60-90DT, 65-90, 65-90DT, 70-90, 70-90DT, 80-90, 80-90DT, 85-90, 85-90DT, 90-90, 90-90DT	5119771
<b>17088</b>	3	Calandra radiatore nuda		100.90, 100.90DT, 110.90, 110.90DT, 90-90, 90-90DT	44905506, 44905526, 5119913
<b>17094</b>	4	Calandra radiatore		100.55C, 100.90, 100.90DT, 110.90, 110.90DT, 55-90, 55-90DT, 60-90, 60-90DT, 65-90, 65-90DT, 70-90, 70-90DT, 80-90, 80-90DT, 85-90, 85-90DT, 90-90, 90-90DT	5119890
<b>58056</b>	5	Calandra nuda senza griglie		55-66S, 55-66S DT, 60-66S, 60-66S DT, 60-93, 60-93 DT, 60-94, 60-94 DT, 65-66S, 65-66S DT, 65-93, 65-93 DT, 65-94, 65-94 DT, 70-66S, 70-66S DT, 72-93, 72-93 DT, 72-94, 72-94 DT, 80-66S, 82-93, 82-93 DT, 82-94, 82-94 DT, 88-93, 88-93 DT, 88-94, 88-94 DT	5169647
<b>59786</b>	6	Calandra completa		55-66S, 55-66S DT, 60-66S, 60-66S DT, 60-93, 60-93 DT, 60-94, 60-94 DT, 65-66S, 65-66S DT, 65-93, 65-93 DT, 65-94, 65-94 DT, 70-66S, 70-66S DT, 72-93, 72-93 DT, 72-94, 72-94 DT, 80-66S, 82-93, 82-93 DT, 82-94, 82-94 DT, 88-93, 88-93 DT, 88-94, 88-94 DT	5169647

<b>17087</b>	1	Griglia inferiore	<b>NEW HOLLAND</b>	TK85-55, TK95-55	5132658, 5175977
<b>17089</b>	2	Griglia superiore		TK85-55, TK95-55	5132244, 5175978
<b>17094</b>	4	Calandra radiatore		TK100-55, TK85-55, TK95-55	5132683, 5175979
<b>58056</b>	5	Calandra nuda senza griglie		TK62-85, TK62-85 M, TK72-85, TK72-85 M, TK82-85 M, TK88-85 M	5169647
<b>59786</b>	6	Calandra completa		TK62-85, TK62-85 M, TK72-85, TK72-85 M, TK82-85 M, TK88-85 M	5169647

**CINGHETTA ADATTABILE**

COURROIE ADAPTABLE  
COVER BELT ADAPTABLE  
KOFFERRIEMEN PASSEND ZU  
CORREAS ADAPTABLE



Art./Ref.	Brand	Applicazione/Application	Rif. Orig./Orig. Ref.
<b>08495</b>	<b>FIAT</b>	100.90-100.90 DT, 110.90-110.90 DT, 115.90-115.90 DT, 1180, 1280, 130.90 130.90DT, 1380, 140.90 140.90DT, 140.90-140.90 DT, 1580, 160.90-160.90 DT, 180.90-180.90 DT, 1880, 474, 55.46, 55.46 DT, 55.56-55.56 DT, 55.66, 55.66 DT, 55.90-55.90 DT, 565, 566, 570, 60.46-60.46 DT, 60.56 DT, 60.65, 60.66, 60.66 DT, 60.90-60.90 DT, 65.46, 65.46 DT, 65.56, 65.56 DT, 65.66, 65.66 DT, 665, 666, 670, 70.56-70.56 DT, 70.65, 70.66, 70.66 DT, 70.90-70.90 DT, 765, 766, 80.46, 80.65, 80.66, 80.66 DT, 80.90-80.90 DT, 90.90-90.90 DT	4999154, 5106362
<b>08495</b>	<b>NEW HOLLAND</b>	TK55.65 F, TK55.65 M, TK55.65 V, TK60.65, TK60.65 M, TK60.65 V, TK60.75, TK60.75 M, TK60.75 V, TK70.65, TK70.65 M, TK70.75, TK70.75 M, TK80.65, TK80.66 DT, TK80.75	4999154, 5106362

**COFANATURE ADATTABILI**

COUVRE-CAPOT MOTEUR ADAPTABLE  
ENGINE HOOD ADAPTABLE  
MOTORHAUBE PASSEND ZU  
TAPA CAPO ADAPTABLE

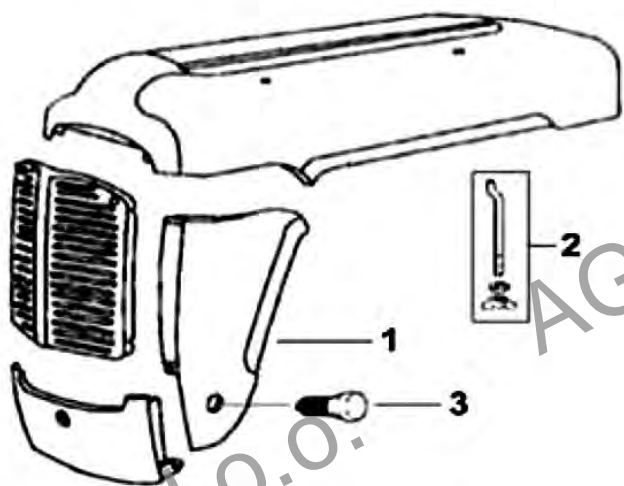

Art./Ref.	Pos.	Descrizione/Description	Brand	Applicazione/Application	Rif. Orig./Orig. Ref.
<b>42045</b>	1	Pannello laterale destro	<b>MASSEY FERGUSON</b>	FE35	826815M91
<b>42046</b>	1	Pannello laterale sinistro			826816M91
<b>42049</b>	2	Asta cofano			826870M1
<b>42048</b>	3	Bullone di fissaggi			180718M1

**PARAFANGHI ADATTABILI**

GARDE BOUE ADAPTABLE  
 FENDERS ADAPTABLE  
 KOTFLUEGEL PASSEND ZU  
 GUARDABARROS ADAPTABLE



Art./Ref.	Pos.	Descrizione/Description	Note/Note	Brand	Applicazione/Application	Rif. Orig./Orig. Ref.
42062	1	Parafango dx/sx		MASSEY FERGUSON	FE35,35, TEA20, TED20, TEF20	1883356M92
42063	2	Parafango sinistro	Con prolunga di sicurezza/ With safety extension		230, 240, 250, 253, FE35,35, TEA20, TED20, TEF20	1884287M97
42064	2	Parafango destro	Con prolunga di sicurezza/ With safety extension			1884286M97
42065	3	Parafango sinistro			230, 240, 250, 265, 275, 290, 298	1679374M92
42066	3	Parafango destro				1679373M92

**PARAFANGHI CORTI PER RUOTE ANTERIORI DEI TRATTORI**

GARDE - BOUE COURT POUR TRACTEUR  
 SHORT MUDGUARD FOR TRACTORS  
 KÜRZE KOTLEDER FÜR TRAKTOREN  
 GUARDABARROS CORTO PARA TRACTORES



Art./Ref.	A mm	B mm	D mm	Lunghezza mm/Lenght mm	Tipo Pneumatico/Tipo Pneumatico	Peso Kg/Weight Kg
12343	440	185	40	700	5.00+5.50+6.00-16, 6.00-19	0.6
12344	530	225	32	810	6.00+6.50+7.50-16, 9.00-16, 7.50-18, 7.50-18, 7.5 L15	0.9
12370	520	240	40	925	6.00+6.50+7.50-20, 9.5-20, 8.3-24	1.1
12371	615	265	45	1000	9.5-24+28, 8.3-28, 10.5-18	1.2
12372	660	310	45	1070	11.2-24+28, 10.5-20	1.6
12373	660	355	45	1085	12.4-24, 13.6-24, 12.5-18+20	1.9
12374	720	355	45	1245	12.4-28+32, 13.6-28	2.1
12375	720	400	40	1315	13.6-28, 14.9-24+26+28+30	2.7
12376	720	410	45	1250	13.6-28	2.4
12377	780	470	50	1300	16.9-24+26, 18.4/70-28	2.9

**CRISTALLO ANTERIORE BASSO ADATTABILE**

VITRE AVANT BAS ADAPTABLE  
 LOWER FRONT GLASS SUITABLE  
 FRONTSCHIEBE PASSEND ZU  
 CRISTAL ANTERIOR BAJO COMPATIBLE

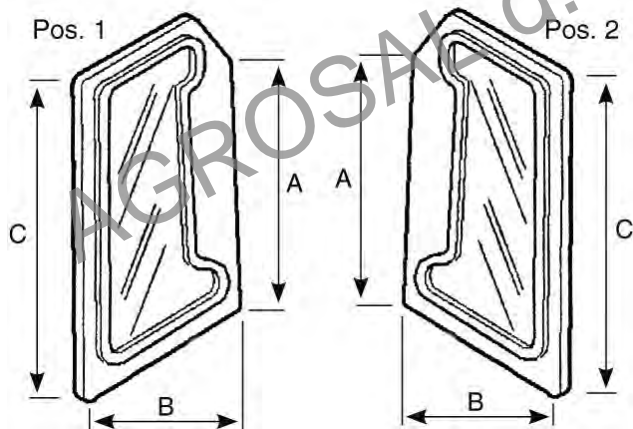

Art./Ref.	A mm	B mm	C mm	Note/Note	Brand	Applicazione/Application	Rif. Orig./Orig. Ref.
<b>59759</b>	530	340	660	DESTRO/RIGHT	<b>FORD</b>	4635, 4835, 5635, 6635, 7635	82002184
<b>59761</b>	530	340	660	SINISTRO/LEFT			82002185
<b>59759</b>	530	340	660	DESTRO/RIGHT	<b>NEW HOLLAND</b>	L60, L65, L75, L85, L95, TL100, TL55F-TL65F-TL75F, TL65, TL65A, TL70, TL80, TL90	82002184
<b>59761</b>	530	340	660	SINISTRO/LEFT			82002185

**CRISTALLO LATERALE ADATTABILE**

VITRE LATERAL ADAPTABLE  
 SIDE GLASS SUITABLE  
 SEITLICHES PASSEND ZU  
 VENTANILLA LATERAL COMPATIBLE

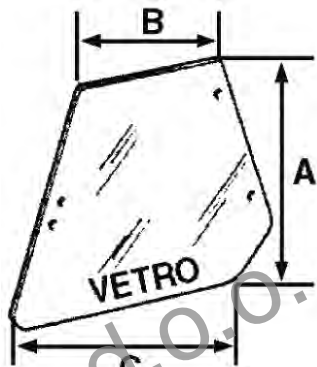

Art./Ref.	A mm	B mm	C mm	Brand	Applicazione/Application	Rif. Orig./Orig. Ref.
<b>26504</b>	672	346	600	<b>FIAT</b>	55.88-55.88 DT, 60.88-60.88 DT, 65.88.65.88 DT, 70.88-70.88 DT, 80.88.80.88 DT, ATTACHMENTS TS23-24-25-28	5124412

**CRISTALLO PORTIERA ADATTABILE**

VITRE DE PORTE ADAPTABLE  
DOOR GLASS SUITABLE  
TURSCEIBE PASSEND ZU  
VENTANILLA DE PUERA COMPATIBLE

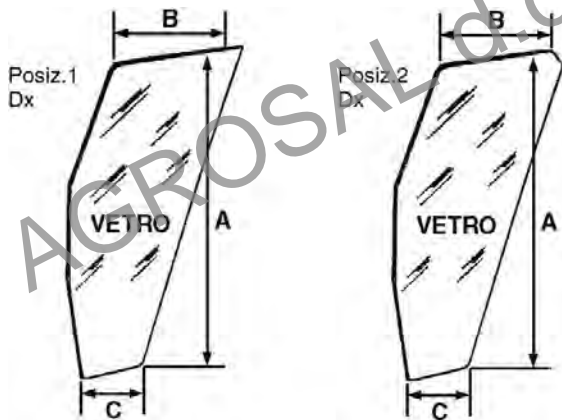

Art./Ref.	A mm	B mm	C mm	Brand	Note/Note	Applicazione/Application	Rif. Orig./Orig. Ref.
26505	1258	524	198	FIAT	SINISTRO/LEFT	140.90 DT, 180.90 DT, ATTACHMENTS TS23-24-25-28	5130883
26506	1258	524	198		DESTRO/RIGHT		5130884
26510	1265	518	199		SINISTRO/LEFT	55.88-55.88 DT, 60.88-60.88 DT, 65.88-65.88 DT, 70.88-70.88 DT, 80.88-80.88 DT, ATTACHMENTS TS23-24-25-28	5124414
26511	1265	518	199		DESTRO/RIGHT		5125038
26505	1258	524	198	FORD	SINISTRO/LEFT	8430, 8630, 8830	5130883
26506	1258	524	198		DESTRO/RIGHT		5130884

**CRISTALLO PORTA INFERIORE ADATTABILE**

VITRE PORTE BAS ADAPTABLE  
LOWER DOOR GLASS SUITABLE  
ERSATZGLAS PASSEND ZU  
VIDRIO PUERTA COMPATIBLE

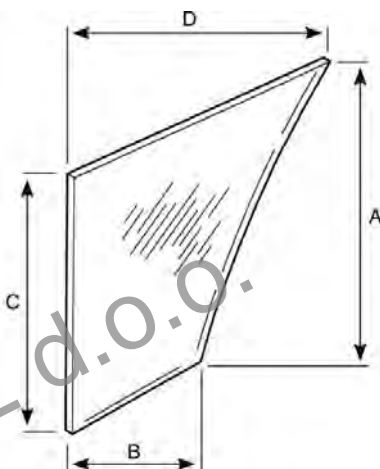

Art./Ref.	A mm	B mm	C mm	D mm	Brand	Applicazione/Application	Rif. Orig./Orig. Ref.
59758	770	400	580	780	FORD	4635, 4835, 5635, 6635, 7635	82002181
59758	770	400	580	780	NEW HOLLAND	L60, L65, L75, L85, L95	82002181

**CRISTALLI POSTERIORI ADATTABILI**

VITRE ARRIERE ADAPTABLE  
 REAR GLASS SUITABLE  
 HECKSCHEIBE OBEN PASSED ZU  
 CRISTAL POSTERIOR COMPATIBLE

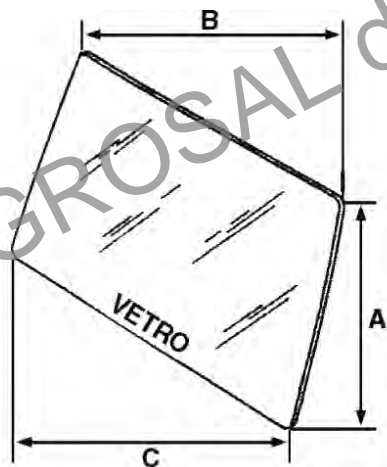

Art./Ref.	A mm	B mm	C mm	Brand	Applicazione/Application	Rif. Orig./Orig. Ref.
26502	585	1330	1370	FIAT	140.90 DT, 180.90 DT, ATTACHMENTS TS23-24-25-28	5130388
26502	585	1330	1370	FORD	8430, 8630, 8830	5130388
26501	908	1498	1310		4635, 4835, 5635, 5640, 6635, 6640, 66400, 7635, 7740, 77400, 7840, 8160, 8240, 8260, 8340, 8360, 8560	5178304, 82005316
26501	908	1498	1310	NEW HOLLAND	L60, L65, L75, L85, L95, LOADERS 90 FL, M115, M135, M160, T5030, T5040, T5050, T5060, T5070, TL100, TL100A, TL55F, TL65, TL65A, TL65F, TL70, TL70A, TL75F, TL80, TL80A, TL90, TL90A, TM110, TM120, TM130, TM140, TM7010, TM7020, TM7030, TM7040, TS100, TS110, TS115, TS120, TS125, TS6000, TS6020, TS6030, TS6040, TS80, TS90	-

**CRISTALLO POSTERIORE SUPERIORE ADATTABILE**

VITRE ARRIERE ADAPTABLE  
 UPPER REAR GLASS SUITABLE  
 HECKSCHEIBE OBEN PASSEND ZU  
 CRISTAL DE PORTON COMPATIBLE

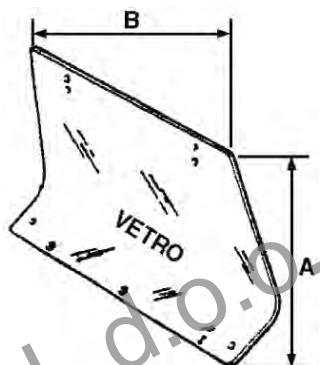

Art./Ref.	A mm	B mm	Brand	Applicazione/Application	Rif. Orig./Orig. Ref.
26509	645	994	FIAT	55.88-55.88 DT, 60.88-60.88 DT, 65.88-65.88 DT, 70.88-70.88 DT, 80.88-80.88 DT, ATTACHMENTS TS23-24-25-28	5124413
61558	732	1442		100.90 - 100.90 DT, 115.90 - 115.90 DT, 140.90 - 140.90 DT, 70.90 - 70.90DT, CABINE CS17, CABINE CS19, CABINE CS21	5129357



**CRISTALLO ANTERIORE ADATTABILE**

VITRE AVANT ADAPTABLE  
FRONTAL GLASS SUITABLE  
FRONTSCHIEBE PASSEND ZU  
CRISTAL ANTERIOR COMPATIBLE

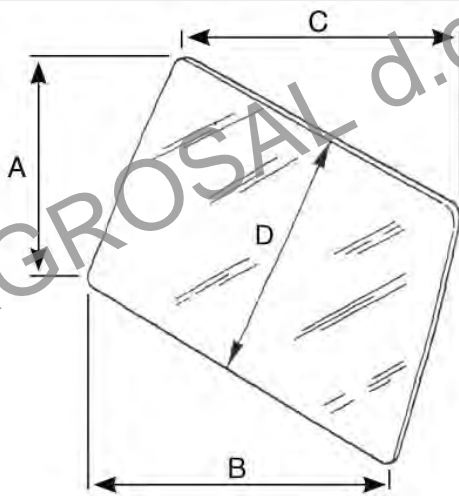

Art./Ref.	A mm	B mm	C mm	D mm	Brand	Applicazione/Application	Rif. Orig./Orig. Ref.
59762	800	1105	780	661.5	SAME LAMBORGHINI HURLIMANN	EXPLORER 55-60-65-70-75-80, EXPLORER 90TURBO - II 90 TURBO, HURLIMAN 356-358, HURLIMAN 446-468-476-478-488	0.9231.210.0/10

**CRISTALLO LATERALE ADATTABILE**

GLACE LATERAL ADAPTABLE  
SIDE GLASS SUITABLE  
SEITLICHES ERSATZGLAS PASSEND ZU  
CRISTAL LATERAL COMPATIBLE

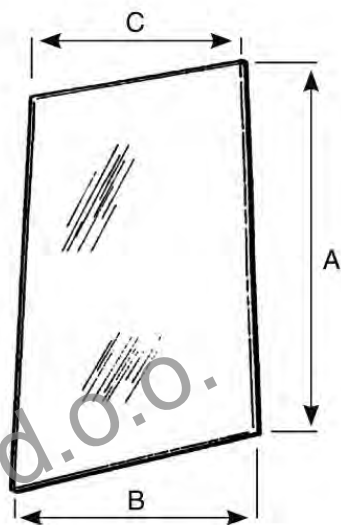

Art./Ref.	A mm	B mm	C mm	Note/Note	Brand	Applicazione/Application	Rif. Orig./Orig. Ref.
59764	720	650	590	BRUNITO/ BRONZE-TINTED	SAME LAMBORGHINI HURLIMANN	ANTARES I 100, EXPLORER 55-60-75, EXPLORER 90TURBO - II 90 TURBO, HURLIMAN 356-358, HURLIMAN 446-468-476-478-488, LAMBORGH 674.70-774.80-874.90	0.9231.214.0

**CRISTALLO LATERALE ADATTABILE**

VERRE LATERAL ADAPTABLE  
SIDE GLASS SUITABLE  
SEITLICHES ERSATZGLAS PASSEND ZU  
CRISTAL LATERAL COMPATIBLE

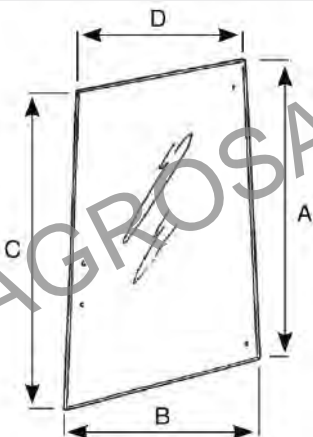

Art./Ref.	A mm	B mm	C mm	D mm	Note/Note	Brand	Applicazione/Application	Rif. Orig./Orig. Ref.
59767	720	580	730	530	BRUNITO/ BRONZE-TINTED	<b>SAME LAMBORGHINI HURLIMANN</b>	GALAXY 100-110-130-150-90, HURLIMAN 496-5116-6136-6170, LAMBORGHINI 1106-1306-956, LASER 100-110-130-150-90	0.9234.214.0/20

**CRISTALLO POSTERIORE INFERIORE ADATTABILE**

GLACE ARRIER ADAPTABLE  
LOWER REAR GLASS SUITABLE  
ERSATZGLAS HINTEN PASSEND ZU  
CRISTAL TRASERO/POSTERIOR COMPATIBLE

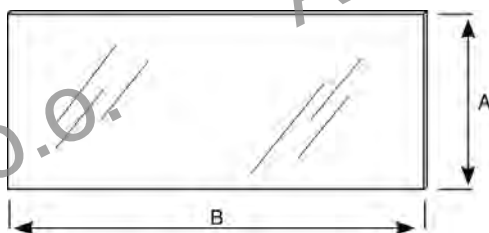

Art./Ref.	A mm	B mm	Note/Note	Brand	Applicazione/Application	Rif. Orig./Orig. Ref.
59765	380	900	BRUNITO/ BRONZE-TINTED	<b>SAME LAMBORGHINI HURLIMANN</b>	ANTARES I 100, EXPLORER 55-60-65-70-75-80, EXPLORER 90TURBO - II 90 TURBO, HURLIMAN 356-358, HURLIMAN 446-468-476-478-488, LAMBORGH 674.70-774.80-874.90	0.9231.255.0

**GUARNIZIONI PER VETRI IN P.V.C.**

JOINTS EN PVC POUR VERRE  
PVC GLASS GASKETS  
PVC-DICHTUNGEN  
JUNTAS DE PVC

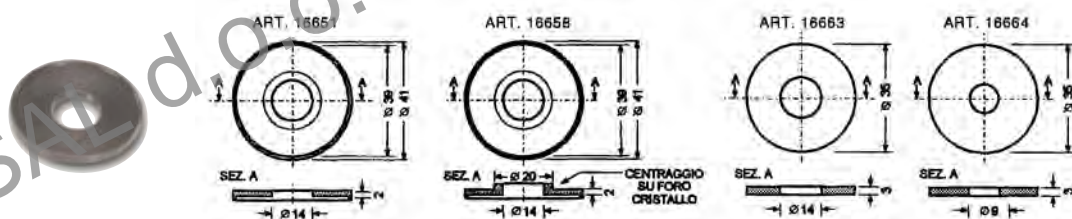

Art./Ref.	Note/Note
16651	Ø esterno 41mm, Ø interno 14mm/Outer Ø 41mm, inner Ø 14mm
16658	Ø esterno 41mm, Ø interno 14mm. Ø 20mm centraggio su foro cristallo./Outer Ø 41mm, inner Ø 14mm, glass hole Ø 20mm
16663	Ø esterno 35mm, Ø interno 14mm/Outer Ø 35mm, inner Ø 9mm
16664	Ø esterno 35mm, Ø interno 9mm/Outer Ø 35mm, inner Ø 9mm

**GUARNIZIONI PER VETRI**

SEALS DE VITRAGE  
GLASS SEALS  
DICHTUNGEN FÜR GLASER  
JUNTAS DE VIDRIOS

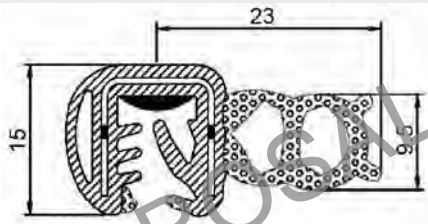

Art./Ref.	Note/Note
57811	ROTOLO DA 5 MT/5-METER ROLL
75767	ROTOLO DA 20 MT/20 METERS

**GUARNIZIONI PER PORTELLONI POSTERIORI PER CAVI ELETTRICI**

CAOUTCHOUCS PROFILÉS POUR LUNETTE ARRIÈRE  
REAR DOOR GLASS RUBBER FOR ELECTRIC CABLES  
DICHTUNG FÜR DIE HECKSCHEIBE  
SELLOS DE VIDRIO TRASERO PARA CABLES ELÉCTRICOS

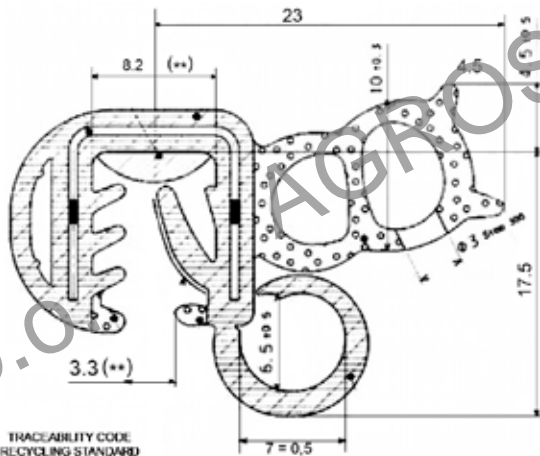

TRACEABILITY CODE  
RECYCLING STANDARD  
DATE/TIME/COMPANY

Art./Ref.	Note/Note
89036	ROTOLO DA 5 MT/5-METER ROLL
89037	ROTOLO DA 20 MT/20-METER ROLL

**GUARNIZIONI COPRILAMIERA FINO A 2,5MM**

JOINTS COUVRENT FEUILLE JUSQU'À 2,5MM  
METAL SHEET SEAL UP TO 2,5MM  
DICHTUNGEN DECKBLATT BIS ZU 2,5MM  
SELLOS CUBREN LA HOJA HASTA 2,5MM

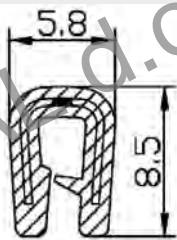

Art./Ref.	Note/Note
89050	ROTOLO DA 5 MT/5-METER ROLL
89051	ROTOLO DA 20 MT/20-METER ROLL

**GUARNIZIONI COPRILAMIERA FINO A 4MM**

JOINTS COUVRENT FEUILLE JUSQU'À 4MM  
METAL SHEET SEAL UP TO 4MM  
DICHTUNGEN DECKBLATT BIS ZU 4MM  
SELLOS CUBREN LA HOJA HASTA 4MM

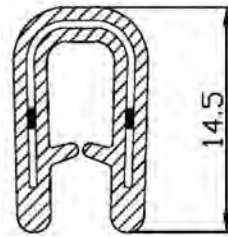

Art./Ref.	Note/Note
89048	ROTOLO DA 5 MT/5-METER ROLL
89049	ROTOLO DA 20 MT/20-METER ROLL

**GUARNIZIONI PER TETTO CABINE**

JOINTS POUR LES TOIT DE CABINES  
SEALS FOR CABIN ROOF  
DICHTUNGEN FÜR DACHKABINEN  
SELLOS PARA TECHO DE CABINAS

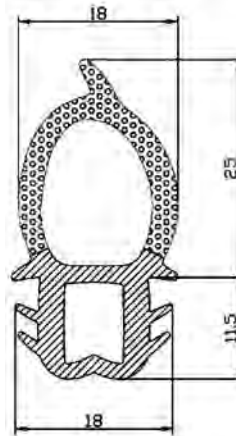

Art./Ref.	Note/Note
89046	ROTOLO DA 5 MT/5-METER ROLL
89047	ROTOLO DA 20 MT/20-METER ROLL

**GUARNIZIONI PER LAMIERA O ABS E COFANI CON AGGANCIAMENTO FINO A 3MM**

SEALS POUR LES METAUX OU ABS ET DES CERCUEILS AVEC RACCORDEMENT AU 3MM  
SEALS FOR METAL OR ABS AND BONNETS WITH HOOKING UP TO 3MM  
SEALS FÜR ROHR ABS UND SARGE MIT EINHAKEN BIS ZU 3MM  
JUNTAS DE METAL O DE ABS Y ATAQUES CON CONEXIÓN A 3MM

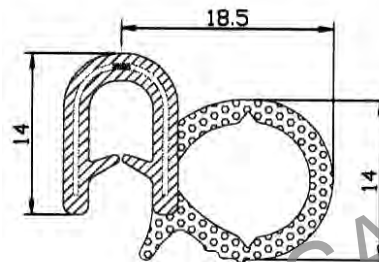

Art./Ref.	Note/Note
89044	ROTOLO DA 5 MT/5-METER ROLL
89045	ROTOLO DA 20 MT/20-METER ROLL

**GUARNIZIONI PER CABINE E PER LAMIERA**

SEALS POUR CABINE ET DE L'ACIER  
SEALS FOR CABS AND METAL SHEETS  
DICHTUNGEN KABINE UND STAHL  
SELLOS DE CABINA Y ACERO

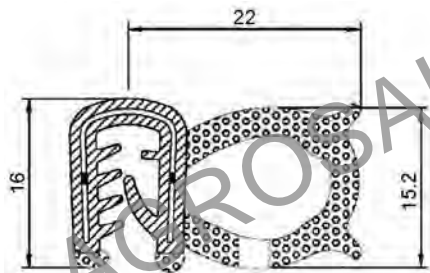

Art./Ref.	Note/Note
89042	ROTOLO DA 5 MT/5-METER ROLL
89043	ROTOLO DA 20 MT/20-METER ROLL

**GUARNIZIONI PER LAMIERA O ABS CON AGGANCO DA 1MM A 3MM**

SEALS POUR LES METAUX OU ABS AVEC RACCORDEMENT DE 1MM AU 3MM  
SEALS FOR METAL OR ABS WITH HOOKING FROM 1MM TO 3MM  
SEALS FÜR ROHR ABS MIT EINHAKEN DE 1MM ZU 3MM  
JUNTAS DE METAL O DE ABS CON CONEXIÓN DA 1MM A 3MM

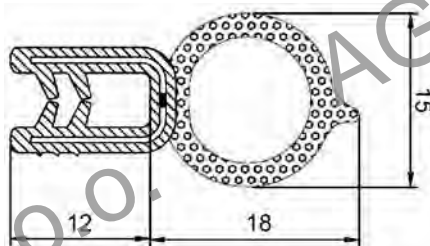

Art./Ref.	Note/Note
89040	ROTOLO DA 5 MT/5-METER ROLL
89041	ROTOLO DA 20 MT/20-METER ROLL

**GUARNIZIONE PER LAMIERA O ABS CON AGGANCO DA 3 MM A 5 MM**

SEALS POUR LES METAUX OU ABS AVEC RACCORDEMENT DE 3MM AU 5MM  
SEALS FOR METAL OR ABS WITH HOOKING FROM 3MM TO 5MM  
SEALS FÜR ROHR ABS MIT EINHAKEN DE 3MM ZU 5MM  
JUNTAS DE METAL O DE ABS CON CONEXIÓN DA 3MM A 5MM

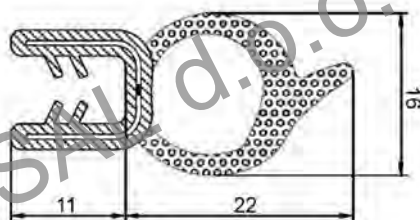

Art./Ref.	Note/Note
89038	ROTOLO DA 5 MT/5-METER ROLL
89039	ROTOLO DA 20 MT/20-METER ROLL

**MANIGLIA ESTERNA AD INCASSO UNIVERSALE PER TRATTORI**

POIGNEE EXTERIEURE A ANCAISSEMENT UNIVERSELLW POUR TRACTEUR  
UNIVERSAL OUTSIDE HANDLE FOR TRACTORS  
UNIVERSALEINBAUGRIFF FUER TRAKTOREN  
MANILLA ESTERNA DE ENCAJE UNIVERSAL PARA TRACTORES

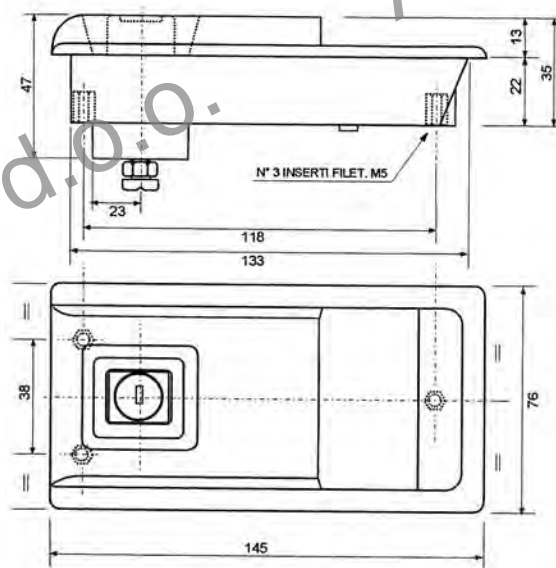

Art./Ref.	Note/Note
37032	Dx e Sx/Rh and Lh

**MANIGLIA PER CABINE TRATTORI**

POIGNEE POUR CABINES TRACTEUR  
HANDLE FOR TRACTOR CAB  
GRIFF FÜR TRAKTORKABINEN  
MANILLA POR CABINAS TRACTORES



Art./Ref.	Note/Note	Colore/Color	Brand	Ricambio/Replacement
16628	Materiale corpo maniglia: <b>plastica</b> Handle body material: <b>Plastic</b>	Nero/Black	A.M.A.	<p><b>16635</b> - SERRATURA UNIVERSALE CABINE CON COPERTURA IN PLASTICA NERA DX / RIGHT LOCK FOR TRACTORS WITH BLACK PLASTIC COVER,</p> <p><b>16636</b> - SERRATURA UNIVERSALE CABINE CON COPERTURA IN PLASTICA NERA SX / UNIVERSAL LEFT DOOR LOCK FOR TRACTORS WITH BLACK PLASTIC COVER,</p> <p><b>16637</b> - SERRATURA UNIVERSALE CABINE CON COPERTURA IN PLASTICA NERA DX / UNIVERSAL DOOR LOCK FOR TRACTORS WITH BLACK PLASTIC COVER, RIGHT,</p> <p><b>16638</b> - SERRATURA UNIVERSALE CABINE CON COPERTURA IN PLASTICA NERA SX / UNIVERSAL DOOR LOCK FOR TRACTORS WITH BLACK PLASTIC COVER, LEFT,</p> <p><b>16643</b> - SERRATURA UNIVERSALE CABINE TRATTORI DX / RH UNIVERSAL TRACTOR DOOR LOCK ,</p> <p><b>16644</b> - SERRATURA UNIVERSALE CABINE TRATTORI SX / LH UNIVERSAL TRACTOR DOOR LOCK</p>

**MANIGLIA PER CABINE TRATTORI**

POIGNEE POUR CABINES TRACTEUR  
HANDLE FOR TRACTOR CAB  
GRIFF FÜR TRAKTORKABINEN  
MANILLA POR CABINAS TRACTORES

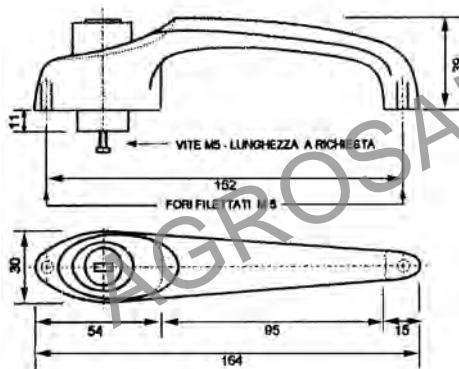

Art./Ref.	Note/Note	Colore/Color	Brand	Ricambio/Replacement
16632	Materiale corpo maniglia <b>Zama</b> Handle body material <b>Zama</b>	Nero/Black	A.M.A.	<p><b>16635</b> - SERRATURA UNIVERSALE CABINE CON COPERTURA IN PLASTICA NERA DX / RIGHT LOCK FOR TRACTORS WITH BLACK PLASTIC COVER,</p> <p><b>16636</b> - SERRATURA UNIVERSALE CABINE CON COPERTURA IN PLASTICA NERA SX / UNIVERSAL LEFT DOOR LOCK FOR TRACTORS WITH BLACK PLASTIC COVER,</p> <p><b>16637</b> - SERRATURA UNIVERSALE CABINE CON COPERTURA IN PLASTICA NERA DX / UNIVERSAL DOOR LOCK FOR TRACTORS WITH BLACK PLASTIC COVER, RIGHT,</p> <p><b>16638</b> - SERRATURA UNIVERSALE CABINE CON COPERTURA IN PLASTICA NERA SX / UNIVERSAL DOOR LOCK FOR TRACTORS WITH BLACK PLASTIC COVER, LEFT,</p> <p><b>16643</b> - SERRATURA UNIVERSALE CABINE TRATTORI DX / RH UNIVERSAL TRACTOR DOOR LOCK ,</p> <p><b>16644</b> - SERRATURA UNIVERSALE CABINE TRATTORI SX / LH UNIVERSAL TRACTOR DOOR LOCK</p>

**MANIGLIE UNIVERSALI PER PORTE ESTERNE DI CABINE TRATTORI**

POIGNEE UNIVERSELLES POUR PORTES EXTERIEURES DU CABINES TRACTEURS  
 UNIVERSAL HANDLE FOR EXTERNAL TRACTORS CAB DOORS  
 UNIVERSALGRIFF FUER KABINEN-AUSSENTUEREN  
 MANILLAS UNIVERSALES PARA PUERTAS DE CABINAS DE TRACTORES

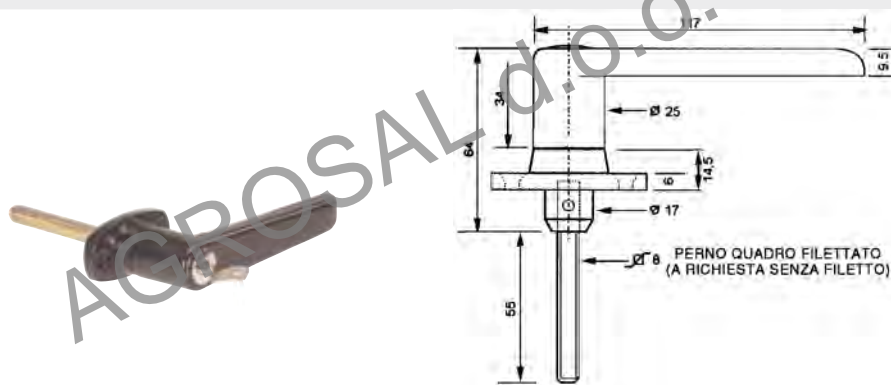

Art./Ref.	Note/Note	Colore/Color
16631	Materiale corpo maniglia: <b>Zama</b> /Handle body material: <b>Zama</b>	Nero/Black

**SERRATURE PER MANIGLIA ART AMA 16631**

FERMETURE POUR REF. AMA 16631  
 DOOR LOCK FOR AMA REF. 16631  
 VERSCHLUSS FUR ART. 16631  
 CERRADURAS PARA ART. 16631

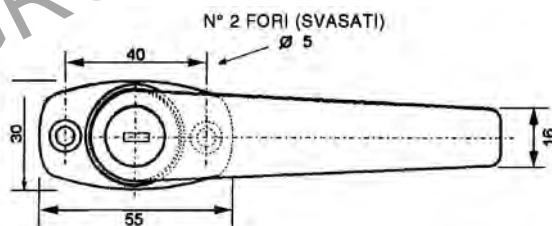

Art./Ref.	Note/Note	Brand	Applicazione/Application
34011	Dx/Rh	A.M.A.	16631
34012	Sx/Lh		

**SERRATURE UNIVERSALI SEMPLICI/REGISTRABILI PER CABINE TRATTORI**

SERRURES UNIVERSELLES SIMPLES/REGLABLES POUR CABINES TRACTEURS  
 SIMPLE/ADJUSTABLE UNIVERSAL LOCKS FOR TRACTOR CABS  
 UNIVERSALVERSCHLUSS EINFACH/EINSTELLBAR FUER KABINEN  
 CERRADURA UNIVERSAL SIMPLE/REGISTRABLE PARA CABINAS DE TRACTORES

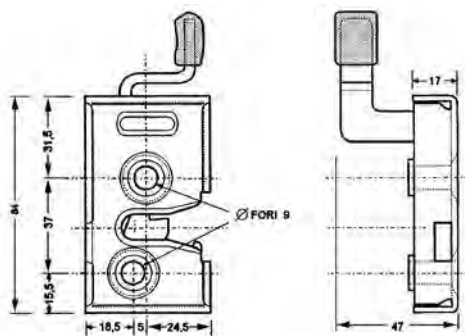

**Note:** In acciaio zincato  
**Notes:** Galvanized steel

Art./Ref.	Note/Note	Brand	Applicazione/Application
16643	DX/RH	A.M.A.	16628
16644	SX/LH		16632

**SERRATURE UNIVERSALI SEMPLICI/REGISTRABILI PER CABINE TRATTORI**

SERRURES UNIVERSELLES SIMPLES/REGLABLES POUR CABINES TRACTEURS  
 SIMPLE/ADJUSTABLE UNIVERSAL LOCKS FOR TRACTOR CABS  
 UNIVERSALVERSCHLUSS EINFACH/EINSTELLBAR FUER KABINEN  
 CERRADURA UNIVERSAL SIMPLE/REGISTRABLE PARA CABINAS DE TRACTORES

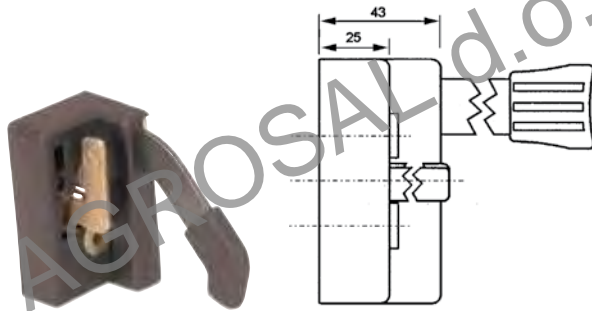

**Note:** Con copertura in plastica nera e leva piegata  
**Notes:** With plastic black cover and bent lever.

Art./Ref.	Note/Note	Brand	Applicazione/Application
16637	DX/RH	A.M.A.	16628
16638	SX/LH		16632

**SERRATURE UNIVERSALI SEMPLICI/REGISTRABILI PER CABINE TRATTORI**

SERRURES UNIVERSELLES SIMPLES/REGLABLES POUR CABINES TRACTEURS  
 SIMPLE/ADJUSTABLE UNIVERSAL LOCKS FOR TRACTOR CABS  
 UNIVERSALVERSCHLUSS EINFACH/EINSTELLBAR FUER KABINEN  
 CERRADURA UNIVERSAL SIMPLE/REGISTRABLE PARA CABINAS DE TRACTORES

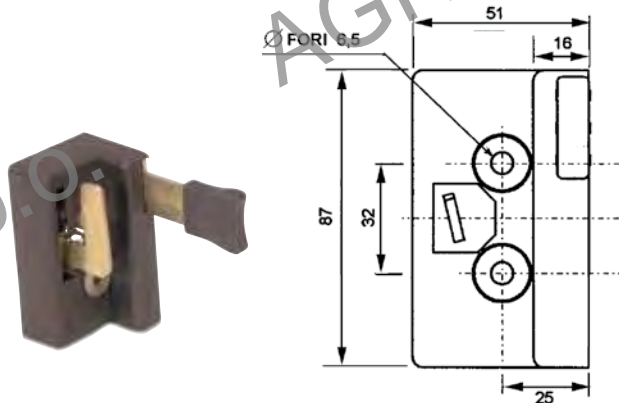

**Note:** Con copertura in plastica nera e leva dritta  
**Notes:** With plastic black cover and straight lever.

Art./Ref.	Note/Note	Brand	Applicazione/Application
16635	Dx/Rh	A.M.A.	16628
16636	SX/LH		16632

**SCONTO PER SERRATURA SEMPLICE**

GACHE POUR SERRURE SIMPLE  
 RABBET FOR SIMPLE LOCK  
 SCHRAUBE FUER VERSCHLUSS EINFACH  
 BISAGRA DE CERRADURA SIMPLE

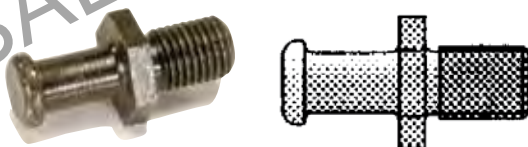

Art./Ref.	Note/Note
16640	M12x1,5

**PROTEZIONE PER SCONTO**

PROTECTION POUR GACHE  
 RABBET PROTECTION  
 SCHUTZ  
 PROTECCIÓN PARA BISAGRA



Art./Ref.
16642

**DADO DI FISSAGGIO SCONTO**

ECROU FIXAGE GACHE  
 RABBET FIXING NUT  
 BEFESTIGUNGSMUTTER  
 TUERCA DE FISAJE PARA BISAGRA

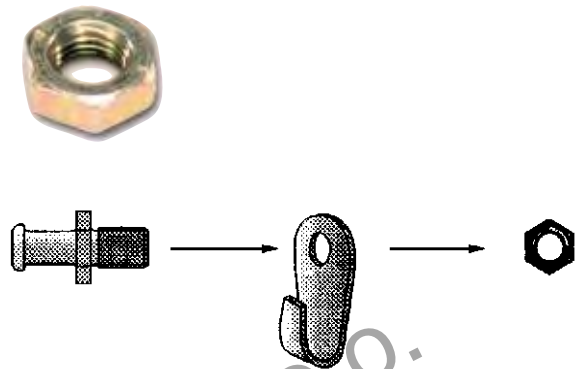

Art./Ref.
16641

**RISCONTO PER SERRATURA REGISTRABILE**

GACHE SERRURES REGLABLES  
 RABBET FOR ADJUSTABLE LOCK  
 SCHRAUBE FUER VERSCHLUSS EINSTELLBAR  
 BISAGRA DE CERRADURA REGISTRABLE

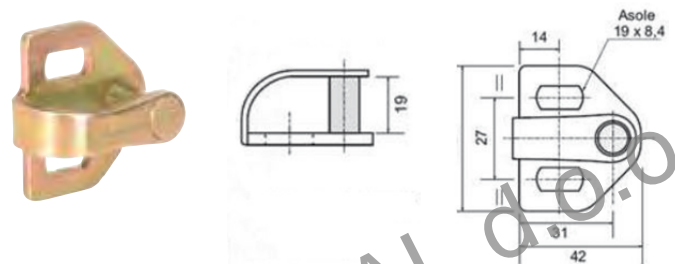

Art./Ref.
16639

**SERRATURA UNIVERSALE PER CABINE TRATTORI**

POIGNEE UNIVERSELLE POUR CABINES TRACTEURS  
 UNIVERSAL LOCKS FOR TRACTOR CABINS  
 UNIVERSALVERSCHLUSS FUER KABINEN  
 CERRADURA UNIVERSAL PARA CABINAS TRACTORES

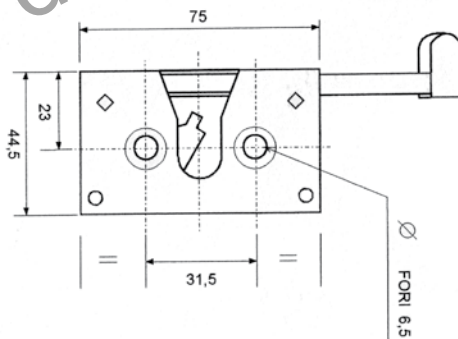

Art./Ref.	Note/Note
37033	Dx/Rh
37034	Sx/Lh

**SERRATURE A BARRA PER CABINE TRATTORI**

FERMETURE LONGUE POUR CABINES TRACTEURS  
 BAR LATCHES TRACTOR CABINS  
 VERSCHLUSS FUER KABINEN  
 CERRADURA CON BRAZO UNIVERSAL PARA CABINAS TRACTORES

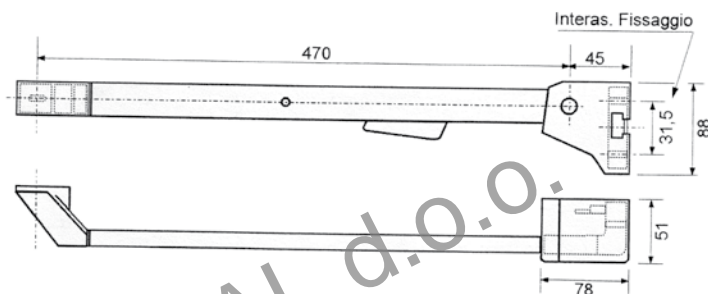

Art./Ref.	Note/Note
37035	Dx/Rh
37036	Sx/Lh

**PIASTRA DI FISSAGGIO SERRATURA**

PLAQUE DE FIXATION POIGNEE  
 FIXING PLATE FOR LOCKS  
 VERSCHLUSSBEFESTIGUNGSPLATTE  
 PLANCHA DE FIJACIÓN CERRADURA

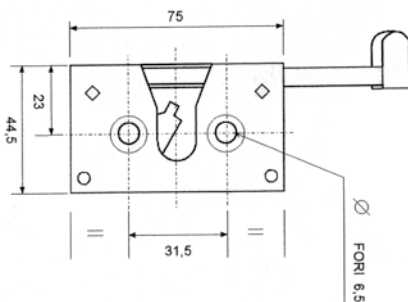

Art./Ref.	Note/Note	Brand	Applicazione/Application
37037	Dx e Sx/Rh and Lh	A.M.A.	37033, 37034, 37035, 37036



**MANIGLIE E SERRATURE PER CABINE ADATTABILI**

POIGRÉES ET FERMETURE POUR CABINES ADAPTABLE

CABINE HANDLES SUITABLE

KABINENGRIFFE PASSEND ZU F

MANILLAS Y CERRADURAS PARA CABINAS COMPATIBLE

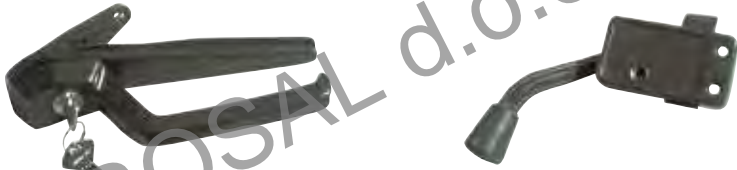

Art./Ref.	Descrizione/Description	Brand	Applicazione/Application	Rif. Orig./Orig. Ref.
15842	Serratura sinistra	FIAT	140.90DT, 160.90DT, 180.90DT, 55.88, 55.88/DT, 60.88, 60.88/DT, 65.88, 65.88/DT, 70.88, 70.88/DT, 80.88, 80.88/DT, ATTACHMENTS TS23-24-25-28	5108380, 5132340
15843	Serratura destra		140.90DT, 160.90DT, 180.90DT, 55.88, 55.88/DT, 60.88, 60.88/DT, 65.88, 65.88/DT, 70.88, 70.88/DT, 80.88, 80.88/DT, ATTACHMENTS TS23-24-25-28	5108381, 5132339
15844	Maniglia destra		140.90DT, 160.90DT, 180.90DT, 55.88, 55.88/DT, 60.88, 60.88/DT, 65.88, 65.88/DT, 70.88, 70.88/DT, 80.88, 80.88/DT, ATTACHMENTS TS23-24-25-28	5108392
15845	Maniglia sinistra		140.90DT, 160.90DT, 180.90DT, 55.88, 55.88/DT, 60.88, 60.88DT, 65/88, 65/88DT, 70.88, 70.88DT, 80.88, 80.88DT, ATTACHMENTS TS23-24-25-28	5108382
15842	Serratura sinistra	FORD	8430, 8630, 8830	5108380
15843	Serratura destra		8430, 8630, 8830	5108381
15844	Maniglia destra		8430, 8630, 8830	5108392
15845	Maniglia sinistra		8430, 8630, 8830	5108382

**MANIGLIA INTERNA DI APPIGLIO**

POIGNEE INTERIEURE PRISE

GRAB INSIDE HANDLE

INNERER HALTEGRIF

MANILLA INTERNA

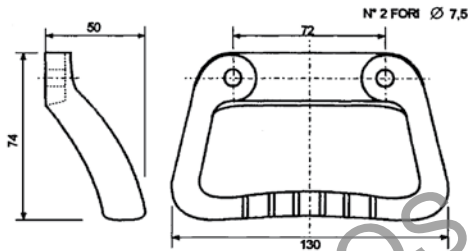

Art./Ref.
16686

**MANIGLIA INTERNA DI APPIGLIO/TIRAPORTA**

POIGNEE INTERIEURE PRISE TIRE-PORTE

GRAB HANDLE

INNERER HALTEGRIF ZUM TUERSCHLIESSEN

MANILLA INTERNA/TIRAPUERTAS

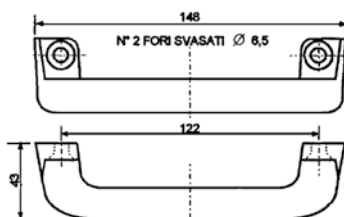

Art./Ref.
16687

**MANIGLIA INTERNA DI APPIGLIO/TIRAPORTA**

POIGNEE INTERIEURE PRISE TIRE-PORTE  
 GRAB INSIDE HANDLE  
 INNERER HALTEGRIFF ZUM TUERSCHLIESSEN  
 MANILLA INTERNA/TIRAPUERTAS

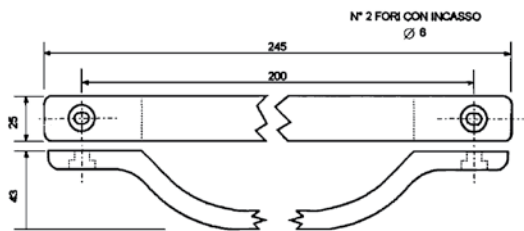

Art./Ref.
16689

**KIT MANIGLIA DI APERTURA A SCATTO PER FINESTRINO**

KIT POIGNEE OUVERTURE FENETRE A DOIGHT  
 SNAP-OPENING HANDLE KIT  
 SATZ GRIFF ZUR FENSTEROEFFNUNG  
 MANILLA DE APERTURA PARA VENTANILLA

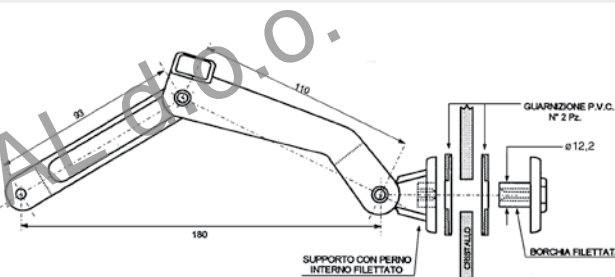

Art./Ref.
16684

**KIT MANIGLIA APERTURA FINESTRINO A SCATTO CON SGANCIO DI EMERGENZA**

KIT POIGNEE OUVERTURE FENETRE A DOIGHT AVEC DECHOCHE D'EMERGENCE  
 SNAP-OPENING HANDLE KIT WITH EMERGENCY REALISING  
 SATZ GRIFF ZUR FENSTEROEFFNUNG MIT AUSLOESEVORRICHTUNG  
 MANILLA DE APERTURA CON DESENGANCHE DE EMERGENCIA PARA VENTANILLA



Art./Ref.
16685

**MANIGLIA CHIUSURA FINESTRINO UNIVERSALE**

POIGNEE FERMETURE FENETRE UNIVERSELLE  
 UNIVERSAL WINDSCREEN CLOSURE HANDLE  
 GRIFF FENSTERVERSCHLUSS UNIVERSAL  
 MANILLAS DE CIERRE DE VENTANILLA UNIVERSAL

Note: Con vite M6x30  
 Notes: With screw M6x30

Art./Ref.	Note/Note
16646	Destro/Right
16647	Sinistro/Left

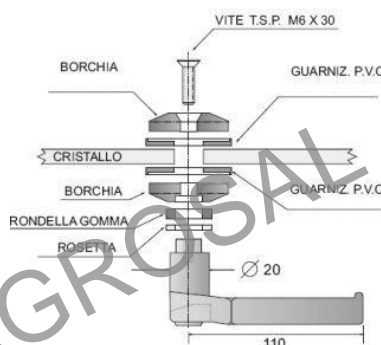

**MANIGLIA CHIUSURA FINESTRINO UNIVERSALE**

POIGNEE FERMETURE FENETRE UNIVERSELLE  
 UNIVERSAL WINDSCREEN CLOSURE HANDLE  
 GRIFF FENSTERVERSCHLUSS UNIVERSAL  
 MANILLAS DE CIERRE DE VENTANILLA UNIVERSAL

**Note:** Con vite M8x35. Con aggancio  
**Notes:** With screw M8x35. With hook

Art./Ref.	Note/Note
16653	Destro/Right
16654	Sinistro/Left

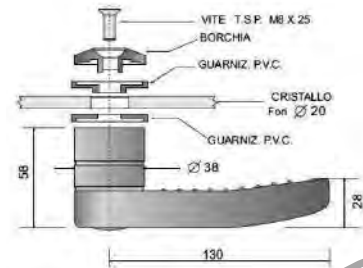

**MANIGLIA CHIUSURA FINESTRINO UNIVERSALE**

POIGNEE FERMETURE FENETRE UNIVERSELLE  
 UNIVERSAL WINDSCREEN CLOSURE HANDLE  
 GRIFF FENSTERVERSCHLUSS UNIVERSAL  
 MANILLAS DE CIERRE DE VENTANILLA UNIVERSAL

**Note:** Con flangia di fissaggio in acciaio zincato a due fori  
**Notes:** With galvanized steel fixing plate two holes.

Art./Ref.	Note/Note
16648	Destro/Right
16649	Sinistro/Left

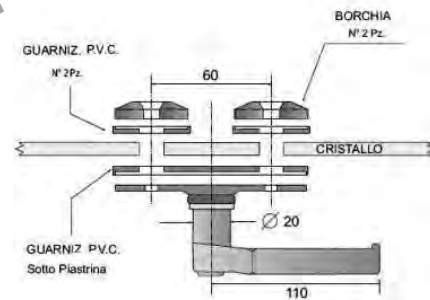

**MANIGLIA CHIUSURA FINESTRINO UNIVERSALE**

POIGNEE FERMETURE FENETRE UNIVERSELLE  
 UNIVERSAL WINDSCREEN CLOSURE HANDLE  
 GRIFF FENSTERVERSCHLUSS UNIVERSAL  
 MANILLAS DE CIERRE DE VENTANILLA UNIVERSAL

**Note:** Con flangia di fissaggio in plastica a due fori  
**Notes:** With plastic fixing plate two holes

Art./Ref.	Note/Note
16655	Destro/Right
16656	Sinistro/Left

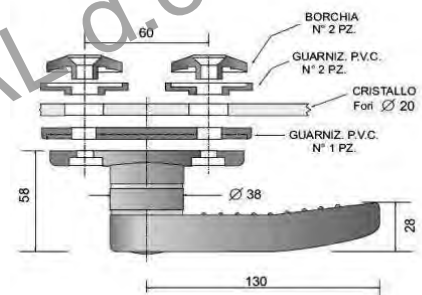

**RISCONTRO PER CHIUSURE FINESTRINO**

GACHE POUR FERMETURE FENETRE  
 RABBIT FOR WINDOW CLOSURES  
 PLATTE FENSTERVERSCHLUSS  
 BISAGRA PARA CIERRE DE VENTANILLA

Art./Ref.
16660

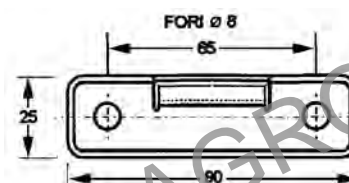

**VERNICI ADATTABILI MACCHINE AGRICOLE**

LAQUES ADAPTABLE MACHINES AGRICOLES  
 PAINTS ADAPTABLE AGRICULTURAL MACHINES  
 LACKE PASSEND ZU LANDMACHINEN  
 BARNICES ADAPTABLE MAQUINARIA AGRICOLAS

**LEGENDA COLORI**

ARANCIO	GRIGIO METALLIZZATO
ARANCIO SCURO	MARRONE
AZZURRO	PANNA
BLU	ROSSO
GIALLO	TERRACOTTA
GRIGIO	TESTA DI MORO
GRIGIO ANTRACITE	VERDE

Note: Latta da 1lt

Notes: 1l Can

Art./Ref.	Note/Note	Colore/Color	Brand	Rif. Orig./Orig. Ref.
04442	carrozzeria/body	Blu/Bleu	BCS	.
88960	carrozzeria/body	Rosso/Red	CARRARO ANTONIO	.
88961	carrozzeria/body	Grigio/Grey		.
88701	carrozzeria/body	Giallo/Yellow	CATERPILLAR	.
88962	carrozzeria/body	Verde/Green	CLAAS	.
88963	carrozzeria/body	Grigio/Grey		.
89032	carrozzeria/body	Verde/Green	FENDT	.
89033	carrozzeria/body	Rosso/Red		.
89031	carrozzeria/body	Grigio/Grey		.
88698	carrozzeria/body	Verde/Green	DEUTZ	.
04444	carrozzeria vecchi modelli / body old models	Arancio/Orange	FIAT	9973437
04446	carrozzeria vecchi modelli / body old models	Terracotta/Hellbraun		9973458
04448	carrozzeria vecchi modelli / body old models	Testa di moro/Brown		9973523
42071	carrozzeria/body	Grigio metallizzato/Metalic grey	FIAT/NEW HOLLAND	.
88700	carrozzeria/body	Blu/Blue		9973459, 9973459
12255	carrozzeria/body	Blu/Blue	FORD	9973439
12257	telaio e cerchi ruota / body and wheel rims	Grigio/Gray		9973416
42071	carrozzeria/body	Grigio metallizzato/Metalic grey		9973497
88694	carrozzeria/body	Arancio/Orange	GOLDONI	.
88695	carrozzeria/body	Verde/Green		.
88699	carrozzeria/body	Verde/Green	HURLIMANN	.
14997	carrozzeria/body	Verde/Green	JOHN DEERE	.
15000	carrozzeria/body	Giallo/Yellow		.
04450	carrozzeria e ruote / body and wheels cerchi ruota	Panna/Cream	LAMBORGHINI	.
04452	carrozzeria/body	Azzurro/Blue	LANDINI	3311965M1
42071	carrozzeria/body	Grigio metallizzato/Metalic grey		1424900M1
88696	carrozzeria/body	Rosso/Red	LAVERDA	.
88697	carrozzeria/body	Rosso/Red	MANITOU	.
04452	carrozzeria/body	Azzurro/Blue	MASSEY FERGUSON	3311965M1
11122	carrozzeria/body	Rosso/Red		.
11126	telaio e motor/body and engine	Marrone/Braun		.
42071	carrozzeria/body	Grigio metallizzato/Metalic grey		1424900M1
11124	carrozzeria e cerchi ruota / body and wheel rims	Grigio antracite/Charcoal Grey		.
04450	carrozzeria e ruote / body and wheels cerchi ruota	Panna/Cream	SAME	.
04456	carrozzeria/body	Arancio/Orange		.
04458	carrozzeria/body	Arancio scuro/Dark orange		.
04467	telaio e motore / chassis and engine	Antracite/Anthracite		.
37947	Antiruggine/Antirust	Grigio/Grey	-	-

## SERIE DECALCOMANIE PER TRATTORI ADATTABILI

SERIES DECALCOMANIES POUR TRACTEURS ADAPTABLE

TRANSFER DECALCOMANIES FOR TRACTORS ADAPTABLE

ABZIEHBILDER FÜR TRAKTOREN PASSEND ZU

SERIE DE CALOMANIA PARA TRACTORES ADAPTABLE

**Note:** Le serie sono complete di etichette istruzioni e comprendono tutte le decalcomanie**Notes:** All series are supplied with instruction booklet and with all stickers

Art./Ref.	Note/Note	Brand	Applicazione/Application
09601			25R
09606			211R
09607			215R
09621			411R
09623			415R
09633			250 DTH
09634			300 DTH
09635			350 DTH
09637			420 DTH
09638			450 DTH
09643			480 DTH
09644			500 DTH
09646			540 DTH
09647			550 DTH
09650			580 DTH
09651	Trattori Fiat doppia trazione / Fiat tractors 4x4	FIAT	600 DTH
09652			640 DTH
09655			670 DTH
09656			680 DTH
09658			750 DTH
09661			780 DTH
09662			800 DTH
09663			850 DTH
09664			850 SPECIAL-OM
09665			880 DTH
09669			1000 DTH
09672			1300 DTH
10867	Trattori Fiat cingolati / Tractor Fiat with tracks	FIAT	312C
10868			332C
10876			455C
10878			505C
10879			555c
10881			605C
10884			665C
10886			765C

**CAVI COMANDO TRASMISSIONE CRONOGIROMETRO A CONTAGIRI ADATTABILI**

CABLE COMPTE-TOURS CHRONOGIROMETRE À COMPTE - TOURS ADAPTABLE

REVOLUTION-COUNTER TRANSMISSION CABLES ADAPTABLE

KABEL KILOMETERZÄHLER - STUNDENZÄHLER PASSEND ZU

CABLE DE MANDO TRANSMISIÓN CRONOGIROMETRO CON CUENTA-REVOLUCIONES ADAPTABLE



Art./Ref.	Brand	Applicazione/Application	Rif. Orig./Orig. Ref.
<b>08476</b>		100.90-100.90 DT, 110.90-110.90 DT, 350, 355, 420, 440, 45.66, 45.66-45.66 DT, 45.66S-45.66S DT, 450, 455, 465, 480, 50.66-50.66 DT, 50.66S-50.66S DT, 500, 505, 540, 55.65, 55.66, 55.90-55.90 DT, 56.66S-56.66S DT, 565, 570, 580, 60.65, 60.90-60.90 DT, 60.93-60.93 DT, 60.94-60.94 DT, 605, 640, 65.90-65.90 DT, 65.93-65.93 DT, 65.94-65.94 DT, 665, 670, 680, 70.65, 70.66, 70.90-70.90 DT, 72.93-72.93 DT, 72.94-72.94 DT, 765, 780, 80.50, 80.56, 80.65, 80.66, 80.76, 80.90-80.90 DT, 82.93-82.93 DT, 82.94-82.94 DT, 85.55, 85.90-85.90 DT, 855, 88.93-88.93 DT, 88.94-88.94 DT, 880, 90.90-90.90 DT, 95.55, 955, 980	4976720, 5108950, 5122475
<b>09124</b>	<b>FIAT</b>	1000, 1180, 1280, 1380, 300, 446, 55.46, 55.46 DT, 55.56, 55.56 DT, 55.66, 55.66 DT, 55.66S, 55.66S DT, 55.88, 55.88 DT, 566, 60.46, 60.46 DT, 60.56 DT, 60.66, 60.66 DT, 60.66S, 60.66S DT, 60.88, 60.88 DT, 65.46, 65.46 DT, 65.56, 65.56 DT, 65.66, 65.66 DT, 65.66S, 65.66S DT, 65.88, 65.88 DT, 666, 70.56, 70.56 DT, 70.66, 70.66 DT, 70.66S, 70.66S DT, 70.88, 70.88 DT, 766, 80.46, 80.50, 80.66, 80.66 DT, 80.66S, 80.66S DT, 80.70, 80.76, 80.88, 80.88 DT, F100, F100 DT, F110, F110 DT, F115, F115 DT, F120, F120 DT, F130, F130 DT, F140, F140 DT	4976770, 5112655, 585603
<b>09125</b>		115.90-115.90 DT, 130.90-130.90 DT, 140.90-140.90 DT, 300, 650	4976718, 580780, 597617
<b>08476</b>	<b>FORD</b>	3435-3935-4135	4976720
<b>09125</b>		8430	4976718
<b>08476</b>	<b>NEW HOLLAND</b>	TK100.55, TK55.65 F, TK55.65 M, TK55.65 V, TK55.75 F, TK55.75 M, TK55.75 V, TK55.85 F, TK55.85 M, TK55.85 V, TK60.65, TK60.65 M, TK60.65 V, TK60.75, TK60.75 M, TK60.75 V, TK60.85 F, TK60.85 M, TK60.85 V, TK62.85-TK62.85 M, TK70.65, TK70.65 M, TK70.75-TK70.75 M, TK72.85-TK72.85 M, TK80.65-TK80.75, TK82.85 M, TK85.55, TK88.85 M, TK95.55	4976720, 5108950
<b>09124</b>		TK80.66 DT	5112655

**CAVO COMANDO ARRESTO MOTORE ADATTABILE**

ARRET MOTEUR AVEC CABLE ET GAINE ADAPTABLE

MOTOR STOP CABLE ADAPTABLE

ABSTELLZUG KPLT. MIT STAHLSEIL PASSEND ZU

CABLE DE MANDO CALADO DEL MOTOR ADAPTABLE



Art./Ref.	Brand	Applicazione/Application	Rif. Orig./Orig. Ref.
<b>08637</b>	<b>FIAT</b>	115.90 115.90DT, 130.90 130.90DT, 1380, 140.90 140.90DT, 55.46, 55.56-55.56 DT, 60.56 DT, 640, 680, 780, 880, 980	4999838, 5011872, 5113225, 5113249, 5113621, 5113622, 5153380
<b>08638</b>		100.90, 1180, 1580, 160.90-160.90 DT, 455C, 566, 666, 70.66, 70.66 DT, 70.66S, 766, 80.66, 80.66 DT, 80.66S, 80.66S DT, 80.76, 980	5104142, 5113254, 5113623, 5153381
<b>08637</b>	<b>FORD</b>	8430	5153380
<b>08638</b>		8630	5153381

**CAVO COMANDO DISINNESTO SOLLEVATORE ADATTABILE**

CABLE DEBRANCHEMENT BRAS DE RELEVAGE ADAPTABLE  
 LEVER CABLE FOR LIFT DISCONNECTION ADAPTABLE  
 KABEL AUSSCHALTUNGSHEBER PASSEND ZU  
 CABLE DE MANDO DESEMBRAGUE LEVANTADOR ADAPTABLE



Art./Ref.	Brand	Applicazione/Application	Rif. Orig./Orig. Ref.
08469	FIAT	580 DT, 680 DT, 780 DT, 880 DT, 980 DT	4999388

**CAVO ACCELERATORE MANUALE ADATTABILE**

CABLE ACCELERATEUR MANUEL ADAPTABLE  
 MANUAL ACCELERATOR CABLE ADAPTABLE  
 KABEL HANDGASHEBEL ADAPTABLE  
 CABLE ACELERADOR MANUAL ADAPTABLE



Art./Ref.	Brand	Applicazione/Application	Rif. Orig./Orig. Ref.
08639	FIAT	100.90, 440, 505C, 55.46, 55.46 DT, 55.56, 55.56 DT, 55.66, 55.66 DT, 55.66S, 55.66S DT, 566, 580, 60.46, 60.46 DT, 60.56 DT, 60.66, 60.66 DT, 60.66S, 60.66S DT, 65.46, 65.46 DT, 65.56, 65.56 DT, 65.66, 65.66 DT, 65.66S, 65.66S DT, 666, 680, 70.56, 70.56 DT, 70.66, 70.66 DT, 70.66S, 70.66S DT, 766, 780, 80.46, 80.46 DT, 80.66, 80.66 DT, 80.66S, 80.66S DT, 80.76, 880, 980	5121344, 5149955
10587		100.90-100.90 DT, 110.90-110.90 DT, 1180, 1280, 1380, 140.90-140.90 DT, 1580, 160.90-160.90 DT, 180.90-180.90 DT, 1880, 55.88-55.88 DT, 60.88-60.88 DT, 65.88-65.88 DT, 65.90-65.90 DT, 70.88-70.88 DT, 70.90-70.90 DT, 80.88-80.88 DT, 80.90-80.90 DT, 80.90-80.90 DT, 85.90-85.90 DT, 90.90-90.90 DT	5113158, 5127687, 5149956
10587	FORD	8430-8630-8830	5149956

**CAVO FRENO DI STAZIONAMENTO ADATTABILE**

CABLE POUR FREIN DE STATIONNEMENT ADAPTABLE  
 PARKING BRAKE CABLE ADAPTABLE  
 KABEL FUER STANDBREMSE PASSEND ZU  
 CABLE PARA FRENO DE MANO ADAPTABLE



Art./Ref.	Brand	Applicazione/Application	Rif. Orig./Orig. Ref.
14212	FORD	4635, 4835, 5635, 6635, 7635	5183158
14212	NEW HOLLAND	L60, L65, L75, L85, L95, TL70, TL80, TL90, TL100	5171397, 5173940, 5174125, 5183158

**TASSELLO ANTIVIBRANTE ADATTABILE**

CHEVILLE CAPOT ADAPTABLE  
 BONNET PLUG ADAPTABLE  
 EINSATZSTÜCKKOFER PASSEND ZU  
 CUNAS ANTIVIBRACIONES ADAPTABLE



Art./Ref.	Brand	Applicazione/Application	Rif. Orig./Orig. Ref.
<b>09127</b>	<b>FIAT</b>	100-90, 100-90 DT, 110-90, 110-90 DT, 115-90, 115-90 DT, 1180, 1280, 130-90, 130-90 DT, 1380, 140-90, 140-90 DT, 1580, 160-90, 160-90 DT, 180-90, 180-90 DT, 1880, 45.66, 55-90, 55-90 DT, 580, 60-90, 60-90 DT, 65-90, 65-90 DT, 680, 70-90, 70-90 DT, 780, 80-90, 80-90 DT, 880, 90-90, 90-90 DT, 980	5112704, 5125604

**CUFFIA PER TIRANTERIA FRENI ADATTABILE**

PROTECTEUR TIRANTS FREINS ADAPTABLE  
 BONNET BRAKE TIE ADAPTABLE  
 HAUBE BREMSGESTÄNGE PASSEND ZU  
 CAJA PARA TIRANTERÍA FRENOS ADAPTABLE



Art./Ref.	Brand	Applicazione/Application	Rif. Orig./Orig. Ref.
<b>08493</b>	<b>FIAT</b>	45.66-45.66DT-45.66S-45.66S DT, 45.76 V, 50.66-50.66DT-50.66S-50.66S DT, 50.86S V-50.86S V DT, 50.86V-50.86V DT, 55.66 F-55.66 F DT-55.66 LP, 55.66 V-55.66 V DT, 55.66-55.66DT-55.66DT LP, 55.66S-55.66S DT, 55.76F - 55.76F DT, 55.76V-55.76V DT, 55.86F-55.86F DT, 55.86S V-55.86S V DT, 55.86V-55.86V DT, 56.66S-56.66S DT, 60.66-60.66 DT, 60.66F-60.66F DT, 60.66LP-60.66LP DT, 60.66S, 60.66S DT, 60.76F-60.76F DT, 60.86F-60.86F DT, 60.86S V-60.86S V DT, 60.86V-60.86V DT, 62.86F-62.86F DT, 65.66-65.66 DT, 65.66S-65.66S DT, 70.66S, 70.76F-70.76F DT, 70.76LP-70.76LP DT, 70.76V, 70.86S V, 70.86S V DT, 70.86V, 70.86V DT, 72.86 LP, 72.86 LP DT, 72.86F, 72.86F DT, 80.66, 80.66DT, 80.66F, 80.66F DT, 80.66S, 80.76F, 80.76F DT, 82.86 LP, 82.86F, 82.86F DT	5117518
<b>08493</b>	<b>FORD</b>	3435-3935-4135, 3830-4030-4230-4430	5117518
<b>08493</b>	<b>NEW HOLLAND</b>	TD3.50 - F480, TD5010-TD5020-TD5030, TD5040-TD5050, TD55D-TD60D-TD65D-TD70D, TD60-TD70-TD80, TD90-TD95, TD65B-TD4020F-TD4030F-TD4040F, TD65F-TD75F-TD85F, TD75D-TD80D-TD85D-TD90D-TD95D	5117518

**CUFFIA LEVA CAMBIO ADATTABILE**

PROTECTEUR LEVIER BOITE-VITESSE ADAPTABLE  
 BONNET GEAR LEVER ADAPTABLE  
 HAUBE GETRIEBEBEBEL PASSEND ZU  
 CAJA PARA PALANCA DEL CAMBIO ADAPTABLE



Art./Ref.	Brand	Applicazione/Application	Rif. Orig./Orig. Ref.
<b>08474</b>	<b>FIAT</b>	100, 110, 45.66, 465, 466, 50, 55, 55.65, 55.66, 565, 566, 570, 580, 60, 60.65, 60.66, 65.66, 665, 666, 670, 680, 70, 70.65, 70.66, 765, 766, 780, 80, 80.46, 80.56, 80.60, 80.65, 80.66, 80.70, 80.75, 80.76, 80.95, 85.55, 855, 880, 90, 95.55, 955, 980	4999009
<b>08474</b>	<b>FORD</b>	3435-3935-4135	4999009
<b>08474</b>	<b>NEW HOLLAND</b>	T6030-T6050-T6070-T6080-T6090, T7.170-T7.185-T7.200-T7.210, T7.220-T7.235-T7.250-T7.260, T7030-T7040-T7050-T7060, TM175-TM190	4999009



**MOLLA IN GOMMA PER SEDILI ADATTABILE**

RESSORT CAOUTHOUC POUR SIEGES ADAPTABLE  
 RUBBER SPRING ADAPTABLE  
 GUMMIFEDER FUR SITZE PASSEND ZU  
 MUELLE DE GOMA PARA ASIENTOS ADAPTABLE



Art./Ref.	Brand	Applicazione/Application	Rif. Orig./Orig. Ref.
06350	FIAT	1000, 1100, 350, 400, 420, 440, 450, 480, 500, 540, 640, 650, 700, 750, 800, 850, 900	595718

**CUFFIA PER FRENO A MANO ADATTABILE**

PROTECTEUR FREIN A MAIN ADAPTABLE  
 HANDBRAKE PROTECTION ADAPTABLE  
 HAUBE FUR HANDBREMSE PASSEND ZU  
 CAJA PARA FRENO DE MANO ADAPTABLE



Art./Ref.	Brand	Applicazione/Application	Rif. Orig./Orig. Ref.
09128	FIAT	580, 680, 780, 80.60, 80.75, 80.95, 880, 980	5106733
09128	FORD	4635-4835-5635-6635-7635	5106733
09128	NEW HOLLAND	L60, L65, L75, L85, L95, NH75TLB-NH85TLB-NH95TLB, T5030-T5040-T5050-T5060-T5070, TL60-TL65-TL75-TL85-TL95, TL60E-TL75E-TL85E-TL95E, TL70, TL80, TL90, TL100, TL70A-TL80A-TL90A-TL100A	5106733

**CUFFIA PER LEVA CAMBIO ADATTABILE**

PROTECTEUR LEVIER BOITE-VITESSE ADAPTABLE  
 GEAR LEVER PROTECTION ADAPTABLE  
 HAUBE GETRIEBEHEBEL PASSEND ZU  
 CAJA PARA PALANCA DEL CAMBIO ADAPTABLE



Art./Ref.	Brand	Applicazione/Application	Rif. Orig./Orig. Ref.
08492	FIAT	570, 580, 670, 680, 780, 880, 980	5100995

**CUFFIA PIANTONE STERZO ADATTABILE**

PROTECTION TUBE DE EMBRAJAGE ADAPTABLE  
 STEERING COLUMN PROTECTION ADAPTABLE  
 HAUBE FÜR GETRIEBEBHEL PASSEND ZU  
 CAJA PALANCA DE DIRECCION ADAPTABLE



Art./Ref.	Brand	Applicazione/Application	Rif. Orig./Orig. Ref.
<b>06351</b>	<b>FIAT</b>	115.90-115.90 DT, 1180, 1280, 130.90-130.90 DT, 1380, 140.90-140.90 DT, 1580, 160.90-160.90 DT, 180.90-180.90 DT, 1880	5110537
<b>06351</b>	<b>FORD</b>	8430-8630-8830	5110537

**CUFFIE LEVA CAMBIO**

SOUFFLETS  
 BELLOWS  
 STAUBSCHUTZ  
 FUELLES PALANCA DE CAMBIO

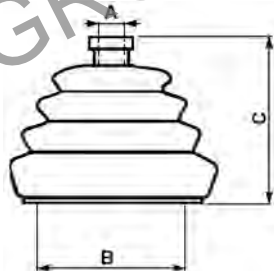

Art./Ref.	A mm	B mm	C mm	Note/Note
<b>00289</b>	10	65	55	Motocoltivatori e trattorini Sep - Valpadana e vari
<b>00297</b>	10	60	85	Fiat 850 e vari - Fiat 850 and various
<b>00294</b>	13	56	70	Landini - Massey Ferguson - Same - Lamborghini
<b>00287</b>	13	82	75	Impieghi vari - Various applications

**CUFFIA PARAPOLVERE LEVA FRIZIONE ADATTABILE**

SOUFFLET POUR LEVIER EMBRAYAGE ADAPTABLE  
 CLUTCH LEVER DUST CAP ADAPTABLE  
 STAUBSCHUTZ KUPPLUNGHEBEL PASSEND ZU  
 FUELLES PRAPOLVO PARA PALANCA EMBRAQUE ADAPTABLE



Art./Ref.	Brand	Rif. Orig./Orig. Ref.
<b>00290</b>	<b>PASQUALI</b>	90028D

**TASSELLI ADATTABILI**

CHEVILLE CAPOT ADAPTABLE

BONNET PLUG ADAPTABLE

EINSATZSTÜCKKOFFER PASSEND ZU

CUNAS ANTIVIBRACIONES ADAPTABLE

Art./Ref.	Note/Note	Brand	Applicazione/Application	Rif. Orig./Orig. Ref.	Immagine/Image
<b>08473</b>	Tassello sportelli- no radiatore	<b>FIAT</b>	100.90-100.90 DT, 110.90-110.90 DT, 115.90-115.90 DT, 130.90-130.90 DT, 140.90-140.90 DT, 160.90-160.90 DT, 180.90-180.90 DT, 300, 35.66-35.66 DT, 350, 440, 45.66-45.66 DT, 45.66S-45.66S DT, 45.76 V, 450, 455, 465, 470, 474, 480, 50.66-50.66 DT, 50.66S-50.66S DT, 50.86 V-50.86 V DT, 50.86S V-50.86S V DT, 55.66 DT LP, 55.66 LP, 55.66 V-55.66 V DT, 55.66F-55.66F DT, 55.76 V-55.76 V DT, 55.76F-55.76F DT, 55.86 F-55.86 F DT, 55.86 V-55.86 V DT, 55.86S V-55.86S V DT, 55.88-55.88 DT, 55.90-55.90 DT, 56.66S-56.66S DT, 60.66 F-60.66F DT, 60.66 LP-60.66 LP DT, 60.76 F-60.76 F DT, 60.86 F-60.86 F DT, 60.86 V, 60.86S V, 60.86S V DT, 60.86V DT, 60.88-60.88 DT, 60.90-60.90 DT, 60.93-60.93 DT, 62.86 F-62.86 F DT, 65.88-65.88 DT, 65.90 DT, 65.90-65.90 DT, 65.93, 65.93-65.93 DT, 65.94-65.94 DT, 70.76 F-70.76 F DT, 70.76 LP-70.76 LP DT, 70.76 V, 70.86 V-70.86 V DT, 70.86S V-70.86S V DT, 70.88-70.88 DT, 70.90-70.90 DT, 72.86 F, 72.86 F DT, 72.86 LP-72.86 LP DT, 72.93-72.93 DT, 72.94-72.94 DT, 80.66 F-80.66 F DT, 80.76 F-80.76 F DT, 80.88-80.88 DT, 80.90-80.90 DT, 82.86 F, 82.86 F DT, 82.86 LP, 82.93-82.93 DT, 82.94-82.94 DT, 85.90-85.90 DT, 88.93-88.93 DT, 88.94-88.94 DT, 90.90-90.90 DT, F110-F110 DT, F115-F115 DT, F120-F120 DT, F130-F130 DT, F140-F140 DT	4068085, 5118180	
<b>08478</b>	Tassello per cofano		1000, 1300, 440, 450, 455, 480, 500, 505, 605, 640, 650, 655, 750, 805, 850	4955052, 591244	
<b>08600</b>	Tassello per cofano		1000, 440, 450, 455, 480, 500, 505, 605, 640, 655, 750, 805, 850	4952524	
<b>08602</b>	Tassello per cofano		100.90-100.90 DT, 110.90-110.90 DT, 115.90-115.90 DT, 1180, 1280, 130.90-130.90 DT, 380, 140.90-140.90 DT, 1580, 160.90-160.90 DT, 180.90-180.90 DT, 1880, 55.90-55.90 DT, 580, 60.90-60.90 DT, 65.90-65.90 DT, 680, 70.90-70.90 DT, 780, 80.90-80.90 DT, 85.55, 85.90-85.90 DT, 855, 880, 90.90-90.90 DT, 955, 980	4996479	
<b>08605</b>	Tassello per cabina		100.90-100.90 DT, 110.90-110.90 DT, 55.88-55.88 DT, 55.90-55.90 DT, 580, 60.88-60.88 DT, 60.90-60.90 DT, 60.93-60.93 DT, 60.94-60.94 DT, 65.88-65.88 DT, 65.90-65.90 DT, 65.93.65.93 DT, 65.94-65.94 DT, 680, 70.88-70.88 DT, 70.90-70.90 DT, 72.93-72.93 DT, 72.94-72.94 DT, 780, 80.88-80.88 DT, 80.90-80.90 DT, 82.93-82.93 DT, 82.94-82.94 DT, 82.94.82.94 DT, 85.90-85.90 DT, 88.93-88.93 DT, 88.94-88.94 DT, 880, 90.90-90.90 DT, 980	4997423	
<b>08606</b>	Tassello per cofano	1000, 1100, 115.90-115.90 DT, 1180, 1280, 130.90-130.90 DT, 1300, 1380, 140.90-140.90 DT, 1580, 160.90-160.90 DT, 180.90-180.90 DT, 1880, 300, 350, 355, 400, 440, 450, 455, 480, 500, 505, 540, 605, 640, 650, 655, 700, 750, 800, 805, 850	5111459, 5118472		
<b>08473</b>	Tassello sportelli- no radiatore	<b>FORD</b>	3435-3935-4135, 3830-4030-4230-4430, 8430-8630-8830	5118180	
<b>08602</b>	Tassello per cofano		8430-8630-8830	5106927	
<b>08605</b>	Tassello per cabina		4635-4835-5635-6635-7635	4997423	
<b>08606</b>	Tassello per cofano		8430-8630-8830	5111459, 5118472	
<b>08602</b>	Tassello per cofano	<b>NEW HOLLAND</b>	TK100.55, TK160.55, TK85.55, TK95.55	5106927	
<b>08605</b>	Tassello per cabina		L60, L65, L75, L85, L95, T5030-T5040-T5050-T5060-T5070, TL70-TL80-TL90-TL100, TL70A-TL80A-TL90A-TL100A	4997423	
<b>08606</b>	Tassello per cofano		T4020-T4030-T4040-T4050, TK160-55, TN60A-TN70A-TN75A-TN85A-TN95A	5111459, 5118472	

**IMPUGNATURA DISINNESTO FRIZIONE STERZO ADATTABILE**

POIGNEE DEBRAYAGE FRICTION DIRECTION ADAPTABLE  
 STEERING CLUTCH DISINGAGE HANDLE ADAPTABLE  
 AUSLOSUNGSGRIFF LENKUNGSKUPPLUNG PASSEND ZU  
 EMPUNADURA DESEMBRAGUE DEL EMBRAGUE DE DIRECCION ADAPTABLE



Art./Ref.	Brand	Applicazione/Application	Rif. Orig./Orig. Ref.
08491	FIAT	100 C, 120C, 1355C, 311 C, 355 C, 411 C, 45 C, 455 C, 50 C, 505 C, 555 C, 605 C, 60C, 655 C, 70 C, 80, 80 C, 80.50, 80.70, 805 C, 90 C	541001, 578159, 9966943

**CAVETTO PORTIERA ADATTABILE**

CABLE PORTIERE ADAPTABLE  
 DOOR CABLE ADAPTABLE  
 WAGENSCHLAGKABEL PASSEND ZU  
 CABLE PORTERA ADAPTABLE



Art./Ref.	Brand	Applicazione/Application	Rif. Orig./Orig. Ref.
09129	FIAT	140-90 DT, 1580, 160-90 DT, 180-90 DT, 55-88, 55-88 DT, 60-88, 60-88 DT, 65-88, 65-88 DT, 70-88, 70-88 DT, 780, 80-88, 80-88 DT	5120144
09129	FORD	8430, 8630, 8830	5120144

**ATTACCO MOLLA A GAS**

ATTAQUE RESSORT A GAZ  
 GAS SPRING CONNECTION  
 VERBINDUNGSTUECK GASFEDER  
 ATAGUE AMORTIGUADOR



Art./Ref.	Note/Note
16673	Kit completo attacco molla a gas/Complete gas spring connection kit
16674	Corpo attacco molla a gas + 2 guarnizioni + borchia. Particolari A+B+C /Gas spring connection body with 2 seals and stud. Parts A+B+C
16675	Corpo attacco molla a gas. Particolare A /Fastening body for gas spring. Part A

**CERNIERA UNIVERSALE PER CABINE TRATTORI**

CHARNIERE UNIVERSELLE POUR CABINE TRACTEUR  
UNIVERSAL HINGE FOR TRACTOR CABS  
UIIVERSALSCHARNIER KABINEN  
CIERRE UNIVERSAL PARA CABINAS DE TRACTORES

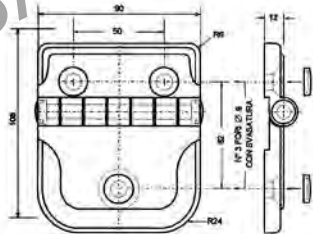

Art./Ref.  
**16678**

**CERNIERA UNIVERSALE PER CABINE TRATTORI**

CHARNIERE UNIVERSELLE POUR CABINE TRACTEUR  
UNIVERSAL HINGE FOR TRACTOR CABS  
UIIVERSALSCHARNIER KABINEN  
CIERRE UNIVERSAL PARA CABINAS DE TRACTORES

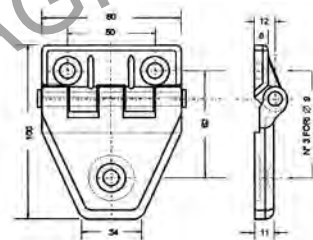

Art./Ref.  
**16679**

**PIASTRINA UNIVERSALE ADATTABILE**

PLAQUE UNIVERSELLE ADAPTABLE  
UNIVERSAL PLATE ADAPTABLE  
LASCHE PASSEND ZU  
PARTE ADAPTABLE



Art./Ref.	Brand	Applicazione/Application	Rif. Orig./Orig. Ref.
<b>27500</b>	<b>FIAT</b>	55.88, 55.88DT, 60/80DT, 60/88, 60/88DT, 65/88, 65/88DT, 70/88, 70/88DT, 80/88, 80/88DT, F100, F100DT, F110, F110DT, F115, F115DT, F120, F120DT, F130, F130DT, F140, F140DT	5130696

**GOMMINO DI PROTEZIONE PER VETRO**

GOMME DE PROTECTION POUR VERRE  
GLASS PROTECTION RUBBER GASKET  
GUMMIPUFFER (GLASSCHUTZ)  
GIUNTA DE PROTECCIÓN PARA VIDRIO

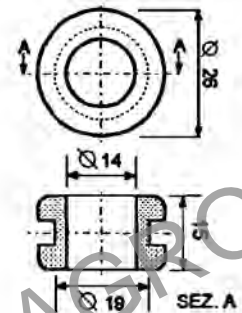

Art./Ref.  
**16680**

**DISTANZIALE PER GOMMINO DI PROTEZIONE VETRO**

ENTRETOISE POUR GOMME DE PROTECTION POUR VERRE  
SPACER FOR GLASS PROTECTION RUBBER GASKET  
DISTANZSTUECK GUMMIPUFFER  
DISTANCIADOR GIUNTA DE PROTECCIÓN PARA VIDRIO

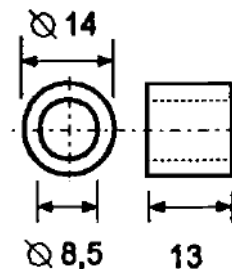

Art./Ref.  
**16681**

**DISTANZIALE CON TESTA PER GOMMINO PROTEZIONE VETRO**

ENTRETOISE POUR GOMME DE PROTECTION POUR VERRE  
SPACER FOR GLASS PROTECTION RUBBER GASKET  
DISTANZSTUECK GUMMIPUFFER  
DISTANCIADOR GIUNTA DE PROTECCIÓN PARA VIDRIO

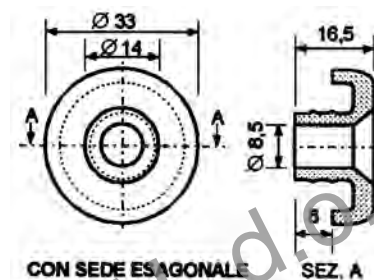

Art./Ref.  
**16682**

**TASSELLO DISTANZIALE PER CERNIERA**

GOUJON ENTRETOISE POUR CHARNIERE  
SPACER BONNET FOR HINGE  
EINSATZ FUER DISTANZSTUECK  
TOPE

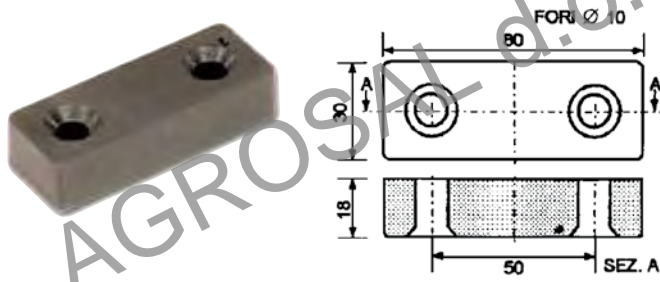

Art./Ref.
16683

**BLOCCHETTO FISSAGGIO VETRO**

BLOC FIXAGE VERRE  
FIXING WINDOW BLOCK  
FIXIERUNGSTUECK  
BLOQUE PARA FISAJE VIDRIO

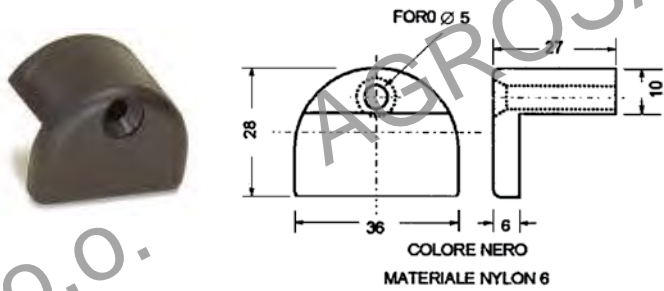

Art./Ref.
16676

**SOTTOVITI PER CABINE**

BOSSAGE  
UNDERSCREW WASHER  
GEWINDESTUETZEN  
DEBAJO DE TORNILLO

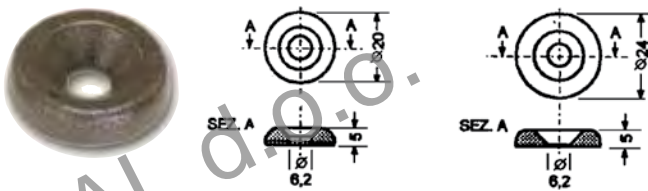

Note: Ø INTERNO 6,2MM  
Notes: INNER Ø 6,2MM

Art./Ref.	Diametro esterno mm/Outside diameter mm	Sede/Hole site
16671	20	Svasata
16672	24	Svasata

**BORCHIE SOTTOVITI UNIVERSALI PER CABINE**

BOSSAGE  
STUD FOR CABINS  
GEWINDESTUETZEN  
DEBAJO DE TORNILLO

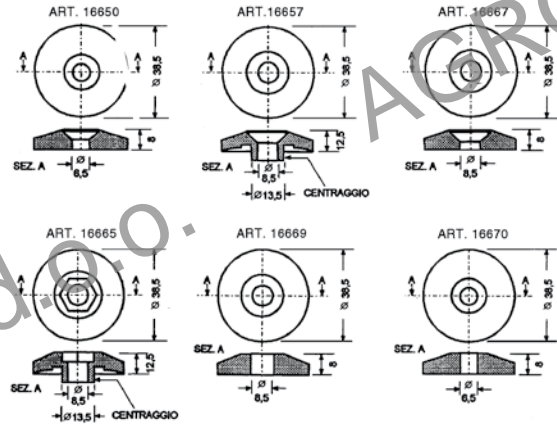

Note: Ø ESTERNO 38,5MM Notes: Ø ESTERNO 38,5MM

Art./Ref.	Sede/Hole site	Foro mm/Hole mm
16650	Svasata	6.5
16657	Svasata	8.5
16667	Svasata	8.5
16665	Esagonale	8.5
16670	Foro passante	6.5
16669	Foro passante	8.5

**TASSELLO PARACOLPI**

GOUJON HEURTOIR  
STOP-BLOCKER BONNET  
EINSATZSTUECK (DAEMPFER)  
TOPE PARAGOLPES



Art./Ref.
16690

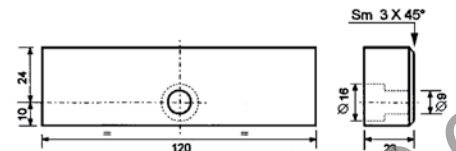

# 1.7.9 Archi di protezione

Roll Bars



**ama**

**Ricambi & accessori per macchine agricole**

**SPARE PARTS & ACCESSORIES FOR AGRICULTURAL MACHINE**

Tutti gli articoli della presente sezione, prodotti da AMA SPA e/o da terzi per conto di AMA, sono adattabili ("non originali") alle marche indicate ai sensi di quanto previsto dal REG. CE n. 1400/2002. I diritti sui marchi citati appartengono ai legittimi proprietari e il loro uso ha l'esclusiva finalità di consentire all'utilizzatore la comparazione dei diversi prodotti.  
All items of this section, manufactured by AMA SPA and/or any third party on behalf of AMA, are adaptable ("non-original") to the brands listed under the provisions of the REG. CE n. 1400/2002. The rights on the trademarks belong to their respective owners and their usage is only aimed to allow the user to compare different products.

**CAPPOTTINA DELUXE PER TRATTORI**

CABINES UNIVERSELS POUR TRACTEUR  
 UNIVERSAL CABIN FOR TRACTORS  
 UNIVERSAL KABINEN FUER TRAKTOREN  
 CABINAS UNIVERSALES PARA TRACTORES

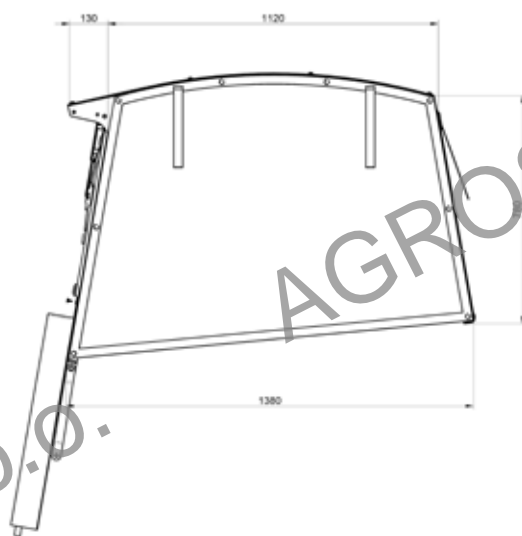

Art./Ref.	Descrizione/Description
85610	Cappottina deluxe applicabile su trattori gommati frutteti e vigneti con roll-bar anteriori/ Deluxe hood applicable on wheeled tractors for orchards and vineyards with front roll bars

**TETTUCCI PARAPIOGGIA UNIVERSALI**

AUVENT PARE-PLUIE UNIVERSELLE  
 UNIVERSAL RAIN COVERS  
 REGENDECKEL UNIVERSAL  
 COBERTURA PARA-LLUVIA UNIVERSAL

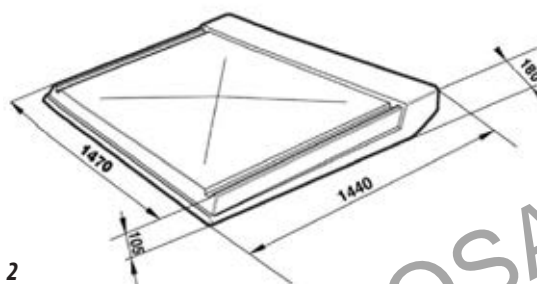
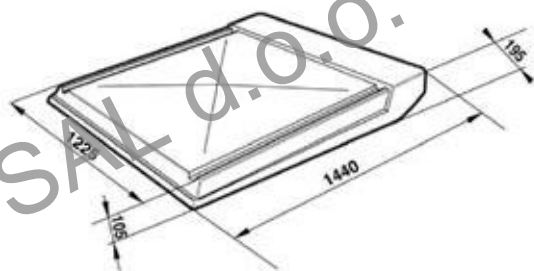

Art./Ref.	Pos.
89268	1
89269	2



## ARCHI DI PROTEZIONE ANTERIORI ABBATTIBILI PER TRATTORI GOMMATI CARREGGIATA STRETTA

ARCEAUX DE PROTECTION AVANT POUR TRACTEURS ROUES A VOIE ETROITE

FRONT ROLL BARS FOR WHEELED NARROW-TRACK TRACTORS

SCHUTZGERUESTE VORDERSEITE FUER BAEDRIGE TRAKTOREN

ARCOS PROTECTORES FRENTE PARA TRACTORES DE RUEDAS, DE VIA ESTRECHA

**Note:** Archi di protezione antiribaltamento per trattori agricoli di tutti i tipi costruiti in conformità alle leggi italiane in materia di sicurezza sul lavoro. Il Decreto Legislativo del 9 aprile 2008 prevede l'adeguamento di tutte le trattori sprovviste di protezione. Certificati di omologazione in conformità alle linee guida Ispesl. Ogni arco è dotato di tutto il necessario per il completo montaggio.

**Notes:** Anti-overturning roll bars for each type of farm tractors, manufactured in accordance with Italian laws about safety at work. The Legislative Decree of 9 April 2008 contemplates the adaptations of all the farm tractors not equipped with protection. Certificate of approval in accordance with the Ispesl guidelines. Each roll bar is provided with all the necessary equipment for the complete assemblage.

Art. Ref.	Brand	Applicazione/Application	
85353	AGRIFULL	345 R - 350 DT	
85358	BERTOLINI	433 N	
85338	CARRARO	TIGRONE 4800	
85339		4400, 5000	
85340		TIGRONE 7000 E SIMILARI	
85341		6000 E SIMILARI (ASSALE A 45)	
85342		SUPERTIGRE 850	
85343		SUPERTIGRE 835 - 841	
85352	FERRARI	95 RS	
85316	FIAT	474 DT E SIMILARI	
85317		55-66	
85318		60-66	
85319		480 R	
85320		500	
85321		670 DTF (VERIFICARE ALT PARAF)	
85322		250, 300	
85323		211	
85361		FORD	3600
85362			4110
85349	GOLDONI	UNIVERSAL 236 - 238 E SIMILARI	
85350	GRILLO	40 HP	
85351		31 V	
85332	LAMBORGHINI	R 235	
85333		R 503	
85334		653 DTF	
85335		880	
85336	LANDINI	5505	
85337	MASSEY FERGUSON	135	
85359	MCCORMICK	INTERNATIONAL 633	
85360		INTERNATIONAL 433	
85354	PASQUALI	959 - 988 - 425 E SIMILARI	
85355		980	
85356		439 - 492	
85357		959/410	
85324	SAME	MINITAURO 60	
85325		CORSARO 70	
85326		AURORA 45	
85327		RANGER 45	
85328		ITALA 35	
85329		DELFINO 35	
85330		SAMETTO V	
85331		SIRENETTA	
85344		VALPADANA	555 RS E SIMILARI
85345			6045 RS-6060 RS-7070 RS E SIMI
85346	6045 DT		
85347	2025 RS		
85348	330 RS		



**ARCHI DI PROTEZIONE POSTERIORI ABBATTIBILI PER TRATTORI GOMMATI CARREGGIATA STANDARD**

ARCEAUX ARRIERE POUR TRACTEURS A ROUES A VOIE NORMALE

REAR ROLL BARS FOR WHEELED NARROW-TRACK TRACTORS

SICHERHEITSGERUESTE FUER ZUGMASCHINEN AUF RADERN SCHMALSPUR LEHRE

ARCO PROTECTORES TRASERO PARA TRACTORES DE TROCHA ESTANDAR

**Note:** Archi di protezione antiribaltamento per trattatrici agricole di tutti i tipi costruiti in conformità alle leggi italiane in materia di sicurezza sul lavoro. Il Decreto Legislativo del 9 aprile 2008 prevede l'adeguamento di tutte le trattatrici sprovviste di protezione. Certificati di omologazione in conformità alle linee guida Ispesl. Ogni arco è dotato di tutto il necessario per il completo montaggio.

**Notes:** Anti-overturning roll bars for each type of farm tractors, manufactured in accordance with italian laws about safety at work. The Legislative Decree of 9 april 2008 contemplates the adaptations of all the farm tractors not equipped with protection. Certificate of approval in accordance with the Ispesl guidelines. Each roll bar is provided with all the necessary equipment for the complete assemblage.

Art./Ref.	Brand	Applicazione/Application
85275	CARRARO	6500
85276		230, 4500
85259	FIAT	400, 450, 500, 540, 550 E SIMILARI, 600, 640, CON PARAFANGHI QUADRATI
85260		400, 450, 500, 540, 550 E SIMILARI, 600, CON PARAFANGHI TONDI
85261		450, 500, 540, 550 E SIMILARI, 600
85262		315, 415
85263		311, 411
85264		1000, 800
85265		70-66 DTF
85266		70-66 LP
85267		211 R
85268		215 N
85269		420
85270		45-66
85271		615, 715
85272		650 FIAT OM, 750 FIAT OM
85273		513 FIAT OM
85274		50 R FIAT OM
85283		FORD
85284	3000, 3000Y	
85285	3055, 4000, 4600, 6600	
85286	5000	
85313	JOHN DEERE	2020
85314		2120
85287	LAMBORGHINI	R 470 DT
85288		R 583
85289		2R
85290		3352, 340 N
85291		R 230
85277		5500 R
85278		CON ASSALE DRITTO, R5000, R5000 N, R5000 S
85279	LANDINI	6530 F
85280		R 7000
85281		R 3200
85282		R 4000, R 4500
85305		135
85306	MASSEY FERGUSON	165 MARK III
85307		35
85308	175	
85315	MCCORMICK	INTERNATIONAL 433
85292	SAME	LEONE 75
85293		CONDOR 55, MINITAURO
85294		CENTAURO E SIMILARI
85295		ITALIA 35
85296		450 V
85297		FALCON

Art./Ref.	Brand	Applicazione/Application
85298	SAME	SATURNO 80
85299		SAMETTO V
85300		PULEDRO
85301		ATLANIA
85302		AURORA
85303		SAMETTO 120 (SERIE AUTOMAZ)
85304		DRAGO
85309	STEYR	80
85310		540 DT
85311		650
85312		18



## ARCHI DI PROTEZIONE POSTERIORI ABBATTIBILI PER TRATTORI CINGOLATI

ARCEAUX ARRIERE POUR TRACTEURS CHENILLES

REAR ROLL BARS FOR TRACKED TRACTORS

SICHERHEITSGERUESTE FUER RAUPENTRAKTOREN

ARCO PROTECTORES TRASERO PARA TRACTORES SOBRE ORUGAS



**Note:** Archi di protezione antiribaltamento per trattori agricoli di tutti i tipi costruiti in conformità alle leggi italiane in materia di sicurezza sul lavoro. Il Decreto Legislativo del 9 aprile 2008 prevede l'adeguamento di tutte le trattori sprovviste di protezione. Certificati di omologazione in conformità alle linee guida Ispeel. Ogni arco è dotato di tutto il necessario per il completo montaggio.

**Notes:** Anti-overturning roll bars for each type of farm tractors, manufactured in accordance with Italian laws about safety at work. The Legislative Decree of 9 April 2008 contemplates the adaptations of all the farm tractors not equipped with protection. Certificate of approval in accordance with the Ispeel guidelines. Each roll bar is provided with all the necessary equipment for the complete assemblage.

Art./Ref.	Brand	Applicazione/Application	
85233	AGRIFULL	355 C	
85234		235 LL	
85235		340 L	
84700	FIAT	312C, 411C, 451C, 505C SUPER, 605C	
85201		455C	
85202		55-65 - 55-75 E SIMILARI	
85203		665C E SIMILARI	
85204		312C	
85205		70-65 - 80-65 E SIMILARI	
85206		60C	
85207		95-55	
85208		OM 655	
85209		465 C	
85227		ITMA	180 L - 300 L
85228			301 L
85229			235N-345N-322N E SIMILARI
85230			500
85231			401 L
85232	600 N		
85215	LAMBORGHINI	C352 - C453 E SIMILARI	
85216		C583 - C653 - C554 - C664 ERGO	
85218		C 754 L	
85217		C 340	
85219	C 774-80		
85220	LANDINI	4500 E SIMILARI	
85221		5830 E SIMILARI	
85222		6030	
85223		7800	
85224		CL 5500	
85225		6830 F (SPECIFICI LARGH RIDUTT)	
85226		CL 4000 SPECIAL	
85210	SAME	FOX 55 C	
85211		FALCON C	
85212		MINITAURO 60 C	
85213		FOX 35 C	
85214		TAURUS	

**ARCHI DI PROTEZIONE PER TRATTORI CINGOLATI AD ABBATTIMENTO TOTALE**

ARCEAUX DE PROTECTION ABAISSANT TOTAL  
 TOTAL LOWERING SAFETY ROLL BARS  
 SCHUTZGERUESTE ABSERKUNG TOTAL  
 ARCOS PROTECTORES BAJAR TOTAL



**Note:** Archi di protezione antiribaltamento per trattori agricoli omologati secondo i codici Ocse.

**Notes:** Rolls bars anti-overturning approved for agricultural tractors in accordance with the codes Ocse

Art./Ref.	Brand	Applicazione/Application
85236	FIAT	605C - 451C E SIMILARI
85237		455C
85238		55-65 - 55-75 E SIMILARI
85239		665C E SIMILARI
85240		312C
85241		70-65 - 80-65 E SIMILARI
85242		465C

**ARCHI DI PROTEZIONE POSTERIORI ABBATTIBILI PER MOTOAGRICOLE**

ARCEAUX ARRIERE POUR TRANSPORTEURS  
 REAR ROLL BARS FOR TRANSPORTERS  
 SICHERHEITSGERUESTE FUER TRANSPORTER  
 ARCO PROTECTORES TRASERO PARA TRANSPORTADORES

**Note:** Archi di protezione antiribaltamento per trattori agricoli di tutti i tipi costruiti in conformità alle leggi italiane in materia di sicurezza sul lavoro. Il Decreto Legislativo del 9 aprile 2008 prevede l'adeguamento di tutte le trattori sprovviste di protezione. Certificati di omologazione in conformità alle linee guida Ispesl. Ogni arco è dotato di tutto il necessario per il completo montaggio.

**Notes:** Anti-overturning roll bars for each type of farm tractors, manufactured in accordance with italian laws about safety at work. The Legislative Decree of 9 april 2008 contemplates the adaptations of all the farm tractors not equipped with protection. Certificate of approval in accordance with the Ispesl guidelines. Each roll bar is provided with all the necessary equipment for the complete assemblage.

Art./Ref.	Brand	Applicazione/Application
85251	BERTOLINI	326
85252		TA 5000
85253		B 1175
85255	CARON	A32
85256		TS52
85257		MC 20
85246	CARRARO	TIGRE TRANS
85247		TIGRECAR 3200
85248		TIGRECAR 5000 - 3700
85258	FERRARI	94 L
85254	GOLDONI	TRANSCAR 40
85245	GRILLO	93 A 951
85243	PASQUALI	946 - 410
85244		446
85249	VALPADANA	2026 E SIMILARI
85250		1820 - 2030



## 1.7.10 Zavorre per trattori

Ballasts for tractors



**ama**

**Ricambi & accessori per macchine agricole**

**SPARE PARTS & ACCESSORIES FOR AGRICULTURAL MACHINE**

Tutti gli articoli della presente sezione, prodotti da AMA SPA e/o da terzi per conto di AMA, sono adattabili ("non originali") alle marche indicate ai sensi di quanto previsto dal REG. CE n. 1400/2002. I diritti sui marchi citati appartengono ai legittimi proprietari e il loro uso ha l'esclusiva finalità di consentire all'utilizzatore la comparazione dei diversi prodotti. All items of this section, manufactured by AMA SPA and/or any third party on behalf of AMA, are adaptable ("non-original") to the brands listed under the provisions of the REG. CE n. 1400/2002. The rights on the trademarks belong to their respective owners and their usage is only aimed to allow the user to compare different products.

**ZAVORRE IN GHISA PER TRATTORI ADATTABILI FIAT**

MESSES D'ALOURDISSEMENT ADAPTABLE POUR TRACTEURS FIAT

BALLASTS FOR TRACTORS ADAPTABLE FIAT

BALLASTE AUS GUSS PASSEND ZU FIAT

LASTRE DE HIERRO COLADO ADAPTABLE FIAT



1



2



3

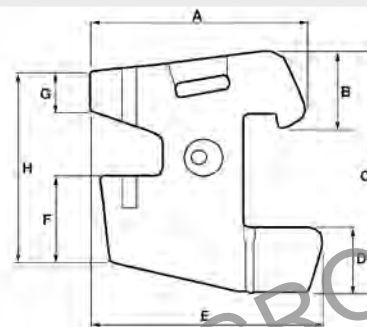

Art./Ref.	Peso Kg/ Weight Kg	Pos.	A mm	B mm	C mm	D mm	E mm	F mm	G mm	H mm	Brand	Applicazione/Application	Rif. Orig./ Orig. Ref.
14257	25	1	300	75	-	115	325	50	110	220		1280, 1380, 1580, 1880, 45.76 V, 50.86 V, 50.86 V DT, 50.86S V, 50.86S V DT, 55.76 F, 55.76 F DT, 55.76 V, 55.76 V DT, 55.86 F, 55.86 F DT, 55.86 V, 55.86 V DT, 55.86S V, 55.86S V DT, 60.76 F, 60.76 F DT, 60.86 F, 60.86 F DT, 60.86 V, 60.86 V DT, 60.86S V, 60.86S V DT, 62.86 F, 62.86 F DT, 70.76 F, 70.76 F DT, 70.76 LP, 70.76 LP DT, 70.76 V, 70.86 V, 70.86 V DT, 70.86S V, 70.86S V DT, 72.86 F, 72.86 F DT, 72.86 LP, 72.86 LP DT, 80.76 F, 80.76 F DT, 82.86 F, 82.86 F DT, 82.86 LP	44907891
14255	33	1	380	90	370	100	420	100	50	250	FIAT	55.46-55.46 DT, 55.56-55.56 DT, 55.66-55.66 DT, 55.66S-55.66S DT, 55.88-55.88 DT, 570, 580, 60.46-60.46 DT, 60.56-60.56 DT, 60.66-60.66 DT, 60.66S-60.66S DT, 60.66S-60.66S DT, 60.88-60.88 DT, 60.93-60.93 DT, 60.94-60.94 DT, 65.46-65.46 DT, 65.56-65.56 DT, 65.66-65.66 DT, 65.66S-65.66S DT, 65.88-65.88 DT, 65.93-65.93 DT, 65.94-65.94 DT, 670, 680, 70.56-70.56 DT, 70.66-70.66 DT, 70.66S-70.66S DT, 70.88-70.88 DT, 72.93-72.93 DT, 72.94-72.94 DT, 780, 80.66-80.66 DT, 80.66S-80.66S DT, 80.88-80.88 DT, 82.93-82.93 DT, 82.94-82.94 DT, 88.93-88.93 DT, 88.93-88.93 DT, 88.94-88.94 DT, 880, 980	5118650, 5163108
85530	40	2	372	136	423	113	449	140	55	310		100.90-100.90 DT, 110.90-110.90 DT, 115.90-115.90 DT, 130.90-130.90 DT, 140.90-140.90 DT, 160.90-160.90 DT, 180.90-180.90 DT, 55.90-55.90 DT, 60.90-60.90 DT, 65.90-65.90 DT, 70.90-70.90 DT, 80.90-80.90 DT, 85.90-85.90 DT, 90.90-90.90 DT, F100-F100 DT, F110-F110 DT, F115-F115 DT, F120-F120 DT, F130-F130 DT, F140-F140 DT, T4020-T4030-T4040-T4050, T4030F-T4040F-T4050F-T4060F, T5.105-T5.95-T5.115, T5030-T5040-T5050-T5060-T5070, TD55D-TD60D-TD65D-TD70D-TD75D, TD60-TD70-TD80-TD85D-TD90-TD95, TD80D-TD90D-TD95D, TK160.55, TL55F-TL65F-TL75F, TL60-TL65-TL70-TL75-TL80-TL85, TL60E-TL75E-TL85E-TL95E, TL70A-TL80A-TL90A-TL100A, TL90-TL95-TL100, TN60A-TN70A-TN75A, TN60A-TN70A-TN75A-TN85A-TN95A, TN60DA-TN70DA-TN75DA-TN85DA, TN60SA-TN70SA-TN75SA-TN85SA, TN75A, TN75FA-TN85FA-TN95FA, TN95DA, TS120-TS125, TS90-TS100-TS110	5119079
36809	45	3											82011619

**ZAVORRE IN GHISA PER TRATTORI ADATTABILI FORD**

MESSES D'ALOURDISSEMENT ADAPTABLE POUR TRACTEURS FORD  
 BALLASTS FOR TRACTORS ADAPTABLE FORD  
 BALLASTE AUS GUSS PASSEND ZU FORD  
 LASTRE DE HIERRO COLADO ADAPTABLE FORD

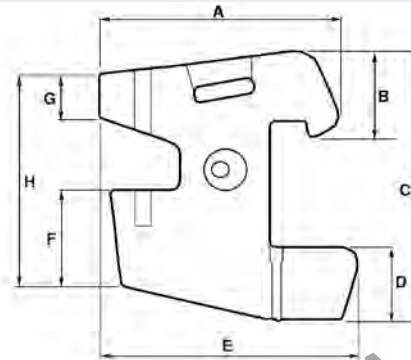

Art./Ref.	Peso Kg/Weight Kg	Pos.	A mm	B mm	C mm	D mm	E mm	F mm	G mm	H mm	Brand	Applicazione/Application	Rif. Orig./Orig. Ref.
14257	25	1	300	75	-	115	325	50	110	220	FORD	3830, 4030, 4230, 4430	44907891
14255	33	1	380	90	370	100	420	100	50	250		3010S, 4010S, 5010S	5163108
36809	45	3	-	-	-	-	-	-	-	-		8160, 8560, 8260, 8360	82011619

**ZAVORRE IN GHISA PER TRATTORI ADATTABILI NEW HOLLAND**

MESSES D'ALOURDISSEMENT ADAPTABLE POUR TRACTEURS NEW HOLLAND  
 BALLASTS FOR TRACTORS ADAPTABLE NEW HOLLAND  
 BALLASTE AUS GUSS PASSEND ZU NEW HOLLAND  
 LASTRE DE HIERRO COLADO ADAPTABLE NEW HOLLAND

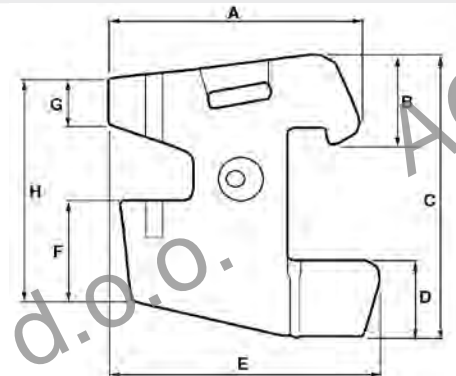

Art./Ref.	Peso Kg/Weight Kg	Pos.	A mm	B mm	C mm	D mm	E mm	F mm	G mm	H mm	Brand	Applicazione/Application	Rif. Orig./Orig. Ref.
14257	25	1	300	75	-	115	325	50	110	220	NEW HOLLAND	1280, 1380, 1580, 1880, 45.76 V, 50.86 V, 50.86 V DT, 50.86S V, 50.86S V DT, 55.76 F, 55.76 F DT, 55.76 V, 55.76 V DT, 55.86 F, 55.86 F DT, 55.86 V, 55.86 V DT, 55.86S V, 55.86S V DT, 60.76 F, 60.76 F DT, 60.86 F, 60.86 F DT, 60.86 V, 60.86 V DT, 60.86S V, 60.86S V DT, 62.86 F, 62.86 F DT, 70.76 F, 70.76 F DT, 70.76 LP, 70.76 LP DT, 70.76 V, 70.86 V, 70.86 V DT, 70.86S V, 70.86S V DT, 72.86 F, 72.86 F DT, 72.86 LP, 72.86 LP DT, 80.76 F, 80.76 F DT, 82.86 F, 82.86 F DT, 82.86 LP, 3830, 4030, 4230, 4430, T4020V, T4030F, T4030N, T4030V, T4040F, T4040N, T4040V, T4050F, T4050N, T4050V, T4060F, T4060N, T4060V, TN55V, TN60VA, TN65F, TN65N, TN65V, TN70F, TN70NA, TN70VA, TN75F, TN75FA, TN75N, TN75NA, TN75V, TN75VA, TN80F, TN85FA, TN90F, TN95F, TN95FA, TN95NA, TN95VA	5177533

Art./Ref.	Peso Kg/ Weight Kg	Pos.	A mm	B mm	C mm	D mm	E mm	F mm	G mm	H mm	Brand	Applicazione/Application	Rif. Orig./Orig. Ref.
85530	40	2	372	136	423	113	449	140	55	310	NEW HOLLAND	100.90-100.90 DT, 110.90-110.90 DT, 115.90-115.90 DT, 130.90-130.90 DT, 140.90-140.90 DT, 160.90-160.90 DT, 180.90-180.90 DT, 55.90-55.90 DT, 60.90-60.90 DT, 65.90-65.90 DT, 70.90-70.90 DT, 80.90-80.90 DT, 85.90-85.90 DT, 90.90-90.90 DT, F100-F100 DT, F110-F110 DT, F115-F115 DT, F120-F120 DT, F130-F130 DT, F140-F140 DT, T4020-T4030-T4040-T4050, T4030F-T4040F-T4050F-T4060F, T5.105-T5.95-T5.115, T5030-T5040-T5050-T5060-T5070, TD55D-TD60D-TD65D-TD70D-TD75D, TD60-TD70-TD80-TD85D-TD90-TD95, TD80D-TD90D-TD95D, TK160.55, TL55F-TL65F-TL75F, TL60-TL65-TL70-TL75-TL80-TL85, TL60E-TL75E-TL85E-TL95E, TL70A-TL80A-TL90A-TL100A, TL90-TL95-TL100, TN60A-TN70A-TN75A, TN60A-TN70A-TN75A-TN85A-TN95A, TN60DA-TN70DA-TN75DA-TN85DA, TN60SA-TN70SA-TN75SA-TN85SA, TN75A, TN75FA-TN85FA-TN95FA, TN95DA, TS120-TS125, TS90-TS100-TS110	47133570, 5093382, 5199608
36809	45	3	-	-	-	-	-	-	-	-		8160, 8560, 8260, 8360, M115-M135-M160, TM115, TM120, TM130, TM150, TM125, TM135, TM140, TM155, TM165, TM175, TM190, TS100, TS110, TS115, TS80, TS90, TV140	82011619, 87353832

**ZAVORRE IN GHISA PER TRATTORI ADATTABILI LANDINI**

MASSES D'ALOURDISSEMENT ADAPTABLE POUR TRACTEURS LANDINI

BALLASTS FOR TRACTORS ADAPTABLE LANDINI

BALLASTE AUS GUSS PASSEND ZU LANDINI

LASTRE DE HIERRO COLADO ADAPTABLE LANDINI

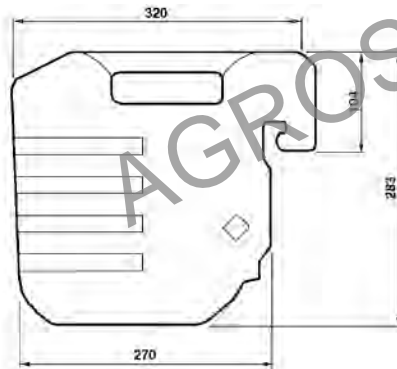

Art./Ref.	Peso Kg/Weight Kg	Brand	Applicazione/Application	Rif. Orig./Orig. Ref.
00422	28	LANDINI	VARI MODELLI	1424992M1



**ZAVORRE IN GHISA PER TRATTORI ADATTABILE SAME LAMBORGHINI HURLIMANN**

MASSES D'ALOURDISSEMENT ADAPTABLE SAME LAMBORGHINI HURLIMANN  
 BALLASTS FOR TRACTORS ADAPTABLE SAME LAMBORGHINI HURLIMANN  
 BALLASTE AUS GUSS PASSEND ZU SAME LAMBORGHINI HURLIMANN  
 LASTRE DE HIERRO COLADO ADAPTBALE SAME LAMBORGHINI HURLIMANN

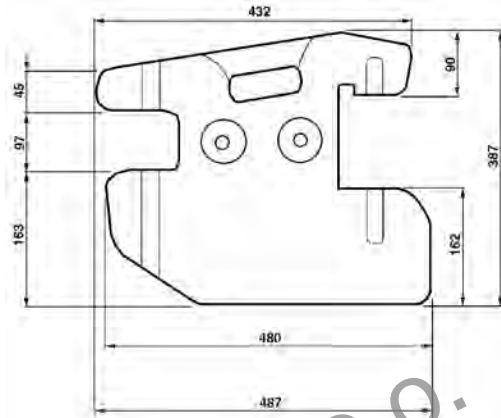

Art./Ref.	Peso Kg/Weight Kg	Brand	Applicazione/Application	Rif. Orig./Orig. Ref.
00424	40	<b>SAME LAMBORGHINI HURLIMANN</b>	ANTARES 110 II, ANTARES 130 II, ARGON 50, ARGON 60, ARGON 70, ASTER 60, ASTER 70, DORADO 60, DORADO 70, EXPLORER 60 II, EXPLORER 60 II SPECIAL, EXPLORER 70 II, EXPLORER 70 II BASSO SPECIAL, EXPLORER 70 II SPECIAL, EXPLORER 70 SPECIAL-> 15500, EXPLORER 80 II, EXPLORER 80 II BASSO SPECIAL, EXPLORER 80 SPECIAL LP, EXPLORER 80 SPECIAL-> 15000, EXPLORER 90 SPECIAL LP, EXPLORER 90 SPECIAL-> 2500, EXPLORER 90T II, FRUTTETO 60 II, FRUTTETO 75 II, FRUTTETO 85 II, GOLDEN 60 COMPATTO, GOLDEN 65 COMPATTO, GOLDEN 75 COMPATTO, GOLDEN 85 COMPATTO, LASER 100, LASER 110, LASER 130, LASER 150, LASER TRANSPORTER 85, ROCK 55, ROCK 60, ROCK 70, ROW CROP 90	0.96929.40.0/10, 0.96929.40.0/20

**ZAVORRE IN GHISA PER TRATTORI ADATTABILE JOHN DEERE**

MASSES D'ALOURDISSEMENT ADAPTABLE POUR TRACTEURS JOHN DEERE  
 BALLASTS FOR TRACTORS ADAPTABLE JOHN DEERE  
 BALLASTE AUS GUSS PASSEND ZU JOHN DEERE  
 LASTRE DE HIERRO COLADO ADAPTABLE JOHN DEERE

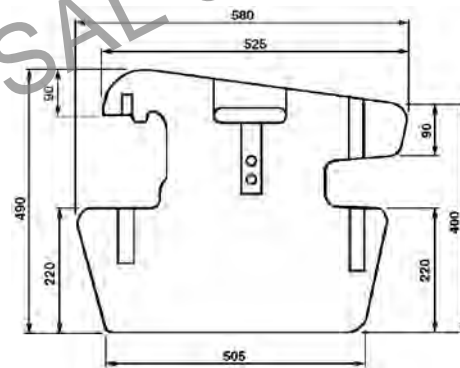

Art./Ref.	Peso Kg/Weight Kg	Note/Notes	Brand	Applicazione/Application	Rif. Orig./Orig. Ref.
10780	50	DX/RH	<b>JOHN DEERE</b>	SERIE 6000, SERIE 7000, SERIE 8000	L38449
11656	50	SX/LH	<b>JOHN DEERE</b>	SERIE 6000, SERIE 7000, SERIE 8000	L38450



# 1.7.11 Motorini d'avviamento e alternatori

Starter motor and alternator



**Ricambi & accessori per macchine agricole**

**SPARE PARTS & ACCESSORIES FOR AGRICULTURAL MACHINE**

Tutti gli articoli della presente sezione, prodotti da AMA SPA e/o da terzi per conto di AMA, sono adattabili ("non originali") alle marche indicate ai sensi di quanto previsto dal REG. CE n. 1400/2002. I diritti sui marchi citati appartengono ai legittimi proprietari e il loro uso ha l'esclusiva finalità di consentire all'utilizzatore la comparazione dei diversi prodotti.  
All items of this section, manufactured by AMA SPA and/or any third party on behalf of AMA, are adaptable ("non-original") to the brands listed under the provisions of the REG. CE n. 1400/2002. The rights on the trademarks belong to their respective owners and their usage is only aimed to allow the user to compare different products.

**TERMOAVVIATORI ADATTABILI**

THERMODEMARREURS ADAPTABLE

THERMOSTARTERS ADAPTABLE

THERMOANLASSER PASSEND ZU

TERMOARRANCADOR ADAPTABLE

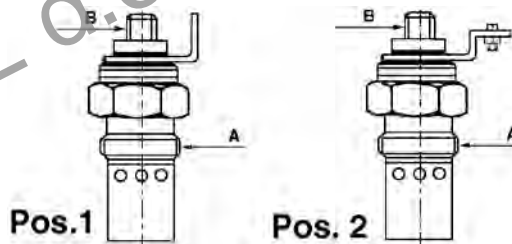

Art./Ref. AMA	BERU	CHAMPION	FIAT	LUCAS - CAV	MARELLI	TECNOMECCANICA
<b>Termoavviatori/Thermostarters</b>						
<b>05068</b>	161 GS	-	5141702	1854104	CTZ 2 U	-
<b>05069</b>	-	-	4724604	1854105	CTZ 4 U	-
<b>05070</b>	154 GS	-	-	1854050	CTZ 5 U	-
<b>05071</b>	-	-	-	1854101	CTZ 1 U	-
<b>05072</b>	166 GS	-	4221168	1854103	CTZ 3 U	-

Art./Ref.	Pos.	Volt/ Volt	Filetto/ Thread A	Filetto/ Thread B	Chiave/ Key	Preriscaldamento/ Preriscaldamento	Brand	Applicazione/Application	Rif. Orig./ Orig. Ref.
<b>05070</b>	2	12	7/8"14 UNF	3/8"24 UNF	24	15 Sec	<b>BEDFORD</b>	CF VAN, M.TJ., MODELLI R, TK5B, TUTTI I MODELLI	-
<b>05070</b>	2	12	7/8"14 UNF	3/8"24 UNF	24	15 Sec	<b>CATERPILLAR</b>	510PFLT, B10/12FLT, B15/25FLT	-
<b>05068</b>	1	12	1/2" BSP	3/8"24 UNF	24	15 Sec	<b>FIAT</b>	1000, 1300, 455C, 480, 550, 570, 600, 605C, 640, 670, 680, 780, 850, 855C, 880, 955C, 980, TL5-TL5H	4176086, 4232051, 4724601, 5141702, 5155859, 5161845
<b>05069</b>	1	24	1/2" BSP	3/8"24 UNF	24	15 Sec		120, 315-316, 40, 50, 55, 79, 80, 90	4724604
<b>05071</b>	1	12	1/2" BSP	3/8"24 UNF	24	15 Sec		300-400-450-500-505-600DT	-
<b>05072</b>	1	24	1/2" BSP	3/8"24 UNF	24	15 Sec		409-410-411-418-470	4221168 EX 4724603 EX 4232052
<b>05070</b>	2	12	7/8"14 UNF	3/8"24 UNF	24	15 Sec	<b>FORD</b>	10/15, F600, SERIE V, TRANSIT V10, V40	-
<b>05071</b>	1	12	1/2" BSP	3/8"24 UNF	24	15 Sec		F100-F350-B600-F600-F700	-
<b>12081</b>	2	12	7/8"14 UNF	3/8"24 UNF	24	15 Sec		-	81806046
<b>05072</b>	1	24	1/2" BSP	3/8"24 UNF	24	15 Sec	<b>GENERAL MOTOR</b>	MOTORI 318M-466F-466M-220F-200G	-
<b>05068</b>	1	12	1/2" BSP	3/8"24 UNF	24	15 Sec	<b>IVECO</b>	100-315-316, 50-55-60-65-79-80-90	-
<b>05072</b>	1	24	1/2" BSP	3/8"24 UNF	24	15 Sec		140-159-160-170-190.35-190.36, 190.42-220-240-260-330-370	-
<b>05070</b>	2	12	7/8"14 UNF	3/8"24 UNF	24	15 Sec	<b>LANDINI</b>	R4500, R7000, R8000, T 20N, TL16C, TL16N	893501M1
<b>12081</b>	2	12	7/8"14 UNF	3/8"24 UNF	24	15 Sec		-	1446935M1
<b>05070</b>	2	12	7/8"14 UNF	3/8"24 UNF	24	15 Sec	<b>LAVERDA</b>	M 120 -M 120R -COMBINE	-
<b>05070</b>	2	12	7/8"14 UNF	3/8"24 UNF	24	15 Sec	<b>LEYLAND</b>	BOXER : TUTTI I MODELLI	-
<b>05070</b>	2	12	7/8"14 UNF	3/8"24 UNF	24	15 Sec	<b>MASSEY FERGUSON</b>	TUTTI I MODELLI	893501M91
<b>12081</b>	2	12	7/8"14 UNF	3/8"24 UNF	24	15 Sec		VARI MODELLI	3583543M2
<b>05070</b>	2	12	3/8"24 UNF	7/8"14 UNF	24	15 Sec	<b>MOTOR IBERICA</b>	TUTTI GLI AUTOCARRI	-
<b>05070</b>	2	12	7/8"14 UNF	3/8"24 UNF	24	15 Sec	<b>PERKINS</b>	MOTOR VARI	2666103
<b>12081</b>	2	12	7/8"14 UNF	3/8"24 UNF	24	15 Sec		-	2666108
<b>05068</b>	1	12	1/2" BSP	3/8"24 UNF	24	15 Sec	<b>SAME</b>	CORSARO 70, LEONE 75, SATURNO 80	-

Art./Ref.	Pos.	Volt/ Volt	Filetto/ Thread A	Filetto/ Thread B	Chiave/ Key	Preriscaldamento/ Preriscaldamento	Brand	Applicazione/Application	Rif. Orig./ Orig. Ref.
05070	2	12	7/8" UNF	3/8" UNF	24	15 Sec	SAVIEM RENAULT	S1000, S5800, S7, S8, SB2, SC5, SD4T, SG2, SG4T, SG5SM5	-
05071	1	12	3/8" UNF	1/2" BSP	24	15 Sec	UNIVERSAL	U400-L400-V400	-
05070	2	12	7/8" UNF	3/8" UNF	24	15 Sec	VOLVO	950SB30 COMBINE, D430, S800 COMB.SM462 COMB., S900, S900 COMBINE, ST265, ST280., T430, VF82, VF83	-

**SERBATOIO ALIMENTAZIONE TERMOAVVIATORE ADATTABILE**

RESERVOIR ADAPTABLE  
TANK FOR CHOKE ADAPTABLE  
BEHÄLTER/TANK FÜR VORGLÜHANLASSER (CHOKE) PASSEND ZU  
DEPÓSITO ADAPTABLE



Art./Ref.	Note/Note	Brand	Applicazione/Application	Rif. Orig./Orig. Ref.
14059	Serbatoio per alimentazione termovavviatore - Tank for choke Plastica - Plastic	FORD	8430, 8830	-
14059	Serbatoio per alimentazione termovavviatore - Tank for choke Plastica - Plastic	FIAT	100.90DT, 110.90DT, 140.90DT, 160.90DT, 180.90DT, 70.90DT, 90.90DT	4613792, 5118586, 5135039, 5135040

**CANDELETTE PRERISCALDAMENTO ADATTABILI**

BOUGIES DE PRECHAUFFAGE ADAPTABLE  
GLOW PLUGS ADAPTABLE  
ERWÄRMUNGSGLÜHKERZEN PASSEND ZU  
BUJITAS PRECALENTAMIENTO ADAPTABLE

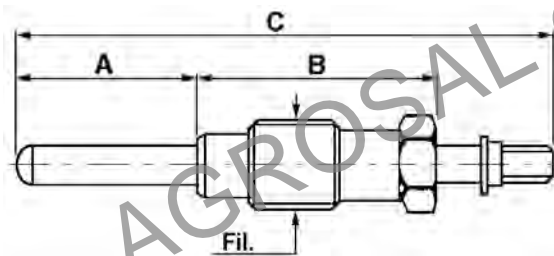

Art./Ref. AMA	BERU	CHAMPION	FIAT	LUCAS - CAV	MARELLI	TECNOMECCANICA
<b>Candele preriscaldamento/Glow plugs</b>						
05064	145 M	-	980611	-	CIM 4A	6240707 R 12
05065	-	-	4137983	-	CIM 14A	6240720 R 12
05066	128 M	-	975331	-	CIM 4B	6240407 R 24
05067	-	-	4122453	-	CIM 14B	6240420 R 24

Art./Ref.	A mm	B mm	C mm	Volt/Volt	Filetto/ Thread A	Chiave/Key	Preriscaldamento/ Preriscaldamento	Note/Notes	Brand	Applicazione/ Application	Rif. Orig./ Orig. Ref.
05064	25	39	99,5	12	M 18x1,5	19	22 Sec.		FIAT	1400 B, 215, 241	980611
05065	24	46	106	12	M 18x1,5	19	22 Sec.	Serie diamante/ Diamond line		411, 415, 615 M1	4137983
05066	25	39	99,5	24	M 18x1,5	19	22 Sec.			1400 B, 215, 241	975331
05067	24	46	106	24	M 18x1,5	19	22 Sec.	Serie diamante/ Diamond line		411, 415, 615 M1	4122453

**CANDELE ADATTABILI**

BOUGIES ADAPTABLE  
SPARK-PLUGS ADAPTABLE  
KERZEN PASSEND ZU  
BUJIAS ADAPTABLE



Art./Ref.	Brand	Applicazione/Application
00635	ACME	AL480, AL550, FE82
00635	COTIEMME	CA150, CA200, CA300, IDRO, NILO, TARO, VARO
00635	CHAMPION	D16, D16J
00667		L14
00635	DENSO	L14-U
00667		W14F-U
00635	GUIDETTI	450, 500, A400
00635	LOMBARDINI	LA 65-72, LA 80-82, LA 85-90
00667		LA 205, LA 250, LA 300, LA 400, LA 490, LAL 250, LAP 205, LAP 250, LAP 300, LAP 400, LAP 490, LAV 250
00635	MARELLI	CM 2N
00667		CW4N
00635	NGK	A-6
00667		B-4H
00635	PASQUALI	MODELLI A PETROLIO
00635	SLANZI	SA14F, SA16F

**TAPPO STARTER ADATTABILE**

BOUCHON DEMARRAGE ADAPTABLE  
STARTER CAP ADAPTABLE  
STARTERPROPFEN PASSEND ZU  
TAPÓN STARTER ADAPTABLE



Art./Ref.	Brand	Applicazione/Application	Rif. Orig./Orig. Ref.
00094	LOMBARDINI	-	9055.008
00106	ACME	TUTTI I MODELLI	890002
00106	RUGGERINI	TUTTI I MODELLI	890-01

**TAPPO SFIATO ADATTABILE LOMBARDINI**

BOUCHON RENIFLARD ADAPTABLE LOMBARDINI  
 BREATHER CAP ADAPTABLE LOMBARDINI  
 ENTLÜFTUNGSDECKEL PASSEND ZU LOMBARDINI  
 TAPÓN RESPIRADERO ADAPTABLE LOMBARDINI



Art./Ref.	Brand	Applicazione/Application	Rif. Orig./Orig. Ref.
01200	LOMBARDINI	100, 3 LD 510, 4 LD 705, 450, 6 LD 360, 820, 91, 96, 97, LA 400, LA 490, LDA 80	9050.050

**PULEGGE AVVIAMENTO ADATTABILI LOMBARDINI**

POULIES DE DEMARRAGE ADAPTABLE LOMBARDINI  
 STARTER PULLEYS ADAPTABLE LOMBARDINI  
 KEILRIEMENSCHLEIBEN PASSEND ZU LOMBARDINI  
 POLEA ARRANQUE ADAPTABLE LOMBARDINI



Art./Ref.	Brand	Applicazione/Application	Rif. Orig./Orig. Ref.
01203	LOMBARDINI	3LD510, LDA450 - 510	6961.029
01208		5LD260, 6LD360, LDA500 - 520 - 530	6960.069
08095		4LD640, 4LD705, 4LD820, LDA 96 - 97 - 100 - 820	6960.061

**MOTORINI AVVIAMENTO ADATTABILI**

MOTEUR DEMARRAGE ADAPTABLE  
 STARTER MOTOR ADAPTABLE  
 STARTER PASSEND ZU  
 MOTORES DE ARRANQUE ADAPTABLE



Art./Ref.	Volt/Volt	Kw/Kw	N° denti/Teeth n°	Brand	Applicazione/Application	Rif. Orig./Orig. Ref.
26490	12	2,7	9	BOSCH	-	0.001.362.032, 0001109405
26491	12	3	9		-	0.001.359.102, 0.001.367.028, 0001262008
51732	12	3	11		-	0001262031
53285	12	3	9		-	0001262029
60260	12	2,7	11	DAVID BROWN	1200, 1210, 1212, 1290, 1294, 1390, 1394, 1410, 1412, 1490, 1494, 850, 880, 950, 990, 995, 996	K262746, K262819, K957340

Art./Ref.	Volt/Volt	Kw/Kw	N° denti/Teeth n°	Brand	Applicazione/Application	Rif. Orig./Orig. Ref.
<b>51735</b>	12	3,1	11	<b>CASE</b>	353, 383, 433, 440, 493, 523, 533, 540, 633, 640, 733, 833	3228192R91, 3228192R91EX
<b>60270</b>	12	3	10		60CX50, 75, CS68, CX50, CX60	388186A1
<b>60276</b>	12	3	10		3210, 3220, 3230, 385, 395, 4210, 4220, 4230, 4240, 454, 474, 485, 495, 574, 584, 595, 674, 684, 685, 695, 784, 785, 795, 884, 895	189330A5, 230428A1, 230428A3, 27508, 529965R93, 537140R92
<b>41134</b>	12	2,8	10	<b>CLAAS</b>	CONSUL, DOMINATOR 58S, DOMINATOR 68S/78S, DOMINATOR 85, MERKATOR 50, MERKATOR 60/75	-
<b>60278</b>	24	5,4	9		116CS, CO228, JAGUAR 685SL, JAGUAR 690SL, JAGUAR 695SL, JAGUAR 820, JAGUAR 840, JAGUAR 860, JAGUAR 880	-
<b>51730</b>	12	3	9	<b>DEUTZ</b>	1000, 10006 MOD., 1002, 1080, 120, 1202, 13006, 2003, 2004, 2005, 2385, 2480, 2580, 2680, 4.50, 4.51, 4.70, 4.71, 50, 6.05, 6.10, 6.30, 6.31, 6.45, 6.50, 6.60, 6.71, 6.81, 6006, 6007, 6206, 6207, 6806, 6807, 6907, 7.10, 7006, 7007, 7206, 7207, 7807, 8.30, 80, 8005, 8006, 85, 86, 90, 9005, 9006, 92, AGROCOMPACT 3.50-3.90, AGROLUX 60, AGROLUX 70, AGROPLUS 60, AGROPLUS 70, AGROPRIMA 3.30-3.50-4.11-4.31, INTRAC, INTRAC 2002, M980	01182233
<b>51731</b>	12	3	9		2004 INTRAC, AGROCOMPACT 3.30 V/F, AGROCOMPACT 3.50 S, AGROCOMPACT 3.50 V/F, AGROPRIMA 4.31 - 4.51 - 4.56, AGROPRIMA 6.06, AGROSTAR 4.61 - 4.71, AGROSTAR 6.11 - 6.21 - 6.31, AGROTRON 106 - 110 - 115, AGROTRON 120 - 135 - 150, AGROTRON 6.00 - 6.05 - 6.15, AGROTRON 6.20 - 6.30 - 6.45, AGROXTRA 3.57 - 4.17 - 4.57, AGROXTRA 6.07 - 6.17, D07 4007 - D07 4507 - D07 4807, D07 5207 - D07 6007 - D07 6207, D07 6507 - D07 6807 - D07 6907, D07 7007 - D07 7207, D07C 4507 - D07C 4807, D07C 5207 - D07C 6007, D07C 6207 - D07C 6507, D07C 6807 - D07C 6907, D07C 7007 - D07C 7207, D07C 7807, DX 3 SC.10 - DX 3 SC.30, DX 3 SC.50 - DX 3 SC.60, DX 3 SC.65 - DX 3 SC.70, DX 3 SC.80 - DX 3 SC.90, DX 3 V/F/S.10 V, DX 3 V/F/S.30 V/F, DX 3 V/F/S.50 S, DX 3 V/F/S.50 V/F, DX 3 V/F/S.70 V/F, DX 3 V/F/S.90 F, DX 3 V/F/S.90 S, DX 3 VC.10 - DX 3 VC.30, DX 3 VC.50 - DX 3 VC.60, DX 3 VC.65 - DX 3 VC.70, DX 3 VC.90, DX 4.10 - DX 4.30, DX 4.50 - DX 4.70, DX 6.05 - DX 6.10 - DX 6.30, DXAB 110 - DXAB 120, DXAB 80 - DXAB 86, DXAB 90 - DXAB 92, HOPFEN DX 4.17 - DX 4.57, INTRAC 6.30, M 1202 SUPER, POWERLINER 4030 - 4035	01163669, 01164994, 01174166, 01178026
<b>51732</b>	12	3	11		3005, D2505, D30	-
<b>53285</b>	12	3	9		AGROCOMPACT 60, AGROCOMPACT 70, AGROCOMPACT 80, AGROCOMPACT 90	-
<b>60267</b>	12	3,6	9		5670HTS, 5680HTS, 5690HTS	-
<b>41134</b>	12	2,8	10	<b>EICHER</b>	3153, 3555, 4060, 4072, 5336	-
<b>26490</b>	12	2,7	9	<b>FIAT</b>	35.66DT-45.66DT-50.66-55.56, 350-400-420-446-450-466-470, 45.66 - 45.66 DT, 45.66S - 45.66S DT, 45.76 V, 474-480-500-500DT-530-533-540, 50.66 - 50.66 DT, 50.66S - 50.66S DT, 540DT-550-566DT-580-600DT, 55.46 - 55.46 DT, 55.56 - 55.56 DT, 55.65 F-M-V, 55.66 - 55.66 DT, 55.66F - 55.66F DT, 55.66LP - 55.66LP DT, 55.66S - 55.66S DT, 55.66V - 55.66V DT, 55.75 F-M-V, 55.76F - 55.76F DT, 55.76V - 55.76V DT, 55.85 F-M-V, 55.86F - 55.86F DT, 55.86S - 55.86S DT, 55.86S V - 55.86S V DT, 55.86V - 55.86V DT, 55.88 - 55.88 DT, 55.90 - 55.90 DT, 60.46 - 60.46 DT, 60.56 DT, 60.65 M-V, 60.66 - 60.66 DT, 60.66F - 60.66F DT, 60.66LP - 60.66LP DT, 60.66S - 60.66S DT, 60.75 M-V, 60.76F - 60.76F DT, 60.85 F-V, 60.88 - 60.88 DT, 60.90 - 60.90 DT, 60.93 - 60.93 DT, 60.94 - 60.94 DT, 62.85 M, 62.86F - 62.86F DT, 640DT-650-666DT-670DT-680DT	4807373
<b>26491</b>	12	3	9		1380DT TURBO-1580DT TURBO, 355C-455C-505C-605C, 550-580-600-640-666-670-680, 65.46 - 65.46 DT, 65.66 - 65.66 DT, 65.66S - 65.66S DT, 65.88 - 65.88 DT, 65.90 - 65.90 DT, 65.93 - 65.93 DT, 65.94 - 65.94 DT, 70.56 - 70.56 DT, 70.65 M, 70.66 - 70.66 DT, 70.66V, 70.66F - 70.66F DT, 70.66LP - 70.66LP DT, 70.66S - 70.66S DT, 70.75 M, 70.76 V, 70.76F - 70.76F DT, 70.76LP - 70.76LP DT, 70.88 - 70.88 DT, 70.90 - 70.90 DT, 72.85 M, 72.93 - 72.93 DT, 72.94 - 72.94 DT, 750DT-780DT-850DT-880DT, 80.65, 80.66 - 80.66 DT, 80.66F - 80.66F DT, 80.66S - 80.66S DT, 80.75, 80.76F - 80.76F DT, 80.88 - 80.88 DT, 80.90 - 80.90 DT, 82.85 M, 82.93 - 82.93 DT, 82.94 - 82.94 DT, 85.90 - 85.90 DT, 88.85 M, 88.93 - 88.93 DT, 88.94 - 88.94 DT, 900-1000SUPER-1300SUPER	4172113, 4187122, 4692478, 4699705, 4702248, 4703751, 4737755, 4807375, 4832942



Art./Ref.	Volt/Volt	Kw/Kw	N° denti/Teeth n°	Brand	Applicazione/Application	Rif. Orig./Orig. Ref.
10801	12	3,5	9	FIAT	100.90 - 100.90 DT, 110.90 - 110.90 DT, 115.90 - 115.90 DT, 130.90 - 130.90 DT, 130.90-140.90-160.90-180.90, 140.90 - 140.90 DT, 1580-1880, 1580-1880-140.90-160.90-180.90, 160.90 - 160.90 DT, 180.90 - 180.90 DT, 90.90 - 90.90 DT, 90.90-100.90-110.90-115.90, F100 - F100 DT, F110 - F110 DT, F115 - F115 DT, F120 - F120 DT, F130 - F130 DT, F140 - F140 DT	4737759, 4755110, 4807376
51730	12	3	9	FENDT	GT-GTA360, GT-GTA365, GT-GTA380, GT345, GTA390, GTA395	
51731	12	3	FARMER200,203,204,205,204S, FARMER240S,250SA,250VA,275VA, FARMER280PA, GT231-GT250-GT275		X830100001	
53287	12	3,1	9		FAVORIT509C-510C-511C-512C, FAVORIT514C-515C	
10801	12	3,5	9	FORD	8430 - 8630 - 8830	4807376
26490	12	2,7	9		3435, 3830, 3935, 4030, 4135, 4635, 4835, 5635, 6635, 7635	4728682, 4807373, 500338953
26491	12	3	9		3010S - 4010S - 5010S, 4230-4430, 4635-4835-5635-6635-7635	4807375, 504059251
22046	12	2,8	10		2000, 2310, 2600, 2610, 2910, 3000, 3430, 3600, 3610, 3910, 3930, 4000, 4100, 4110, 4130, 4600, 4610, 4630, 4830, 5000, 5030, 5110, 5610, 5700, 6000, 6410, 6600, 6610, 6700, 6710, 6810, 7000, 7400, 7600, 7610, 7700, 7710, 7810, 7910, 8000, 8100, 8210, 8600, 8630, 8700, 8730, 8830, 9000, 9600	81859398, 82005342, 83918688, 83981923, D8NN11000AA
60250	12	3	9	GOLDONI	1045R	-
51732	12	3	11	HURLIMANN	345-355-355F-358-360-470-476V, 480-488T-490-496T-5110-5510, 5116T-6115ELITE-6130-6135ELITE, 6136-6150,6190MASTER-6160	-
53285	12	3	9		356,468,478,478-80,488-90, 468H,481H,491H,6136,6165,6160, 5116,5116T,6170,468-70,468CLAB, 6170TURBO-6190	-
41134	12	2,8	10	JCB	110, 1250, 413, 418, 702, 704, 805, 806, 807, 808, 902, SL1000P, SL1500P, SL1750P, SL702P, SL704P, SL900P	-
51732	12	3	11	LAMBORGHINI	115-135FORMULA-165-190RACING, 235-235DT-345-350-352-352L, 352S-503-503L-503S-553-573/60N, 574/60-574/60N-603-603L-603LL, 603S-613DT-653-654R-654DT, 674/70-674/70N BASSO-684-684DT, 684F-684L-684N-714T-2RM-724F, 754R-754DT-774-774/80-774/80DT, 774/80N-775/80NN-777/80-874/90	-
53285	12	3	9		1356-1506-1556-1706, 704-804-854-874-880-904-950, 955-1056-1106-1156-1256-1306, FORMULA105-PREMIUM1050,1060, RACING150,165,190	-
41132	12	2,1	10	LANDINI	5500, 5830, 5840, 5860, 5870, 6030, 6040, 6060, 6070, ADVANTAGE CAB E FOOT STEP :60, ADVANTAGE CAB E FOOT STEP:55, BLIZZARD :60, BLIZZARD:50, CINGOLATI: CF4830, CINGOLATI:C4500, CINGOLATI:C4830, CINGOLATI:C5000, CINGOLATI:C5500, CINGOLATI:C5830, CINGOLATI:CF5030, CINGOLATI:CF5830, CINGOLATI:CF6030, CINGOLATI:CF6060, FRUTTETI 530 F/L/V :4530, FRUTTETI 530 F/L/V: 5530, FRUTTETI 530F/L/V:6030, FRUTTETI 560 F/L/V: 4560, FRUTTETI 560 F/L/V: 5560, FRUTTETI 560F/L/V :6060, GLOBUS:50, GLOBUS:55, NEW SERIE 60:5860, REX CAB E F.S: 60, TREKKER:CF55, TREKKER:CF60, VIGNETI CAB E FOOT STEP :55V, VIGNETI CAB E FOOT STEP :60V, VIGNETI REX CAB:60V, VIGNETI REX CAB:65V	3539389M91

Art./Ref.	Volt/Volt	Kw/Kw	N° denti/Teeth n°	Brand	Applicazione/Application	Rif. Orig./Orig. Ref.
41134	12	2,8	10	LANDINI	10000, 10000S, 12500, 12500 MOD., 13000, 13000 MOD., 14500, 5500, 5830, 6500, 6500(FINO A 1214500), 6550, 6560, 6830, 6840, 6860, 6870, 6880, 7000 SPECIAL, 7000/DT, 7000R, 7550, 7560, 7830, 7860, 7870, 7880, 8000/DT, 8000R, 8550, 8560, 8830, 8860, 8870, 8880, 9060, 9080, 9500, 9880, ADVANTAGE CAB E F.S: 65, ADVANTAGE CAB E F.S: 75, ADVANTAGE CAB E F.S:85, ADVANTAGE CAB:L95, ATLAS:100, ATLAS:70, ATLAS:75, ATLAS:80, ATLAS:85, ATLAS:90, BLIZZARD:65, BLIZZARD:75, BLIZZARD:85, BLIZZARD:95, C10500, C6500 (FINO A 1214500), C75, C85, C95, CF6830, CF75, CF85, CINGOLATI: C6830, CINGOLATI: C7800, CINGOLATI: C7830, CINGOLATI: C8860, CINGOLATI:6500, CINGOLATI:CF6830, FRUTTETI 530 F/L/V: 8530, FRUTTETI 530 F/L/V:6530, FRUTTETI 530 F/L/V:7530, FRUTTETI 560 F/L/V: 8560, FRUTTETI 560 F/L/V:6560, FRUTTETI 560 F/L/V:7560, GHIBLI:100, GHIBLI:80, GHIBLI:90, GLOBUS:65, GLOBUS:75, GLOBUS:80, LEGEND, MISTRAL:40, MYTHOS:100, MYTHOS:90, NEW SERIE 60:6860, NEW SERIE 60:7860, NEW SERIE 60:8860, NEW TREKKER :100C, NEW TREKKER :70C/F/L, NEW TREKKER :80C/F/L, NEW TREKKER :90 C/F/L, REX CAB:100, REX CAB:70, REX CAB:80, REX CAB:90, REX F.S: 100, REX F.S: 80, REX F.S: 90, REX F.S:70, TREKKER :C75, TREKKER :C85, TREKKER :C95, TREKKER :CF65, TREKKER :CF70, TREKKER :CF75, TREKKER :CF85, VIGNETI CAB E F.S:65V, VIGNETI CAB E F.S:75V, VIGNETI REX CAB :70V, VIGNETI REX CAB:80V, VISION:100, VISION:80, VISION:90	3539390M92, 3539395M1
41213	12	2,8	10		LARGE 16000, LARGE 16500	1618050M4
43032	12	2,8	10		LEGEND N/G:115, LEGEND N/G:120, LEGEND N/G:130, LEGEND N/G:140, LEGEND N/G:160, LEGEND N/G:180, LEGEND:105, LEGEND:115, LEGEND:130, LEGEND:145, LEGEND:165	3551773M91, 3648191M92
60272	12	2,8	10		BLIZZARD, FRUTTETO, FRUTTETO CABINATO, FRUTTETO FOOT-STEP, LEGEND 115 - 120 - 130 - 140, LEGEND 145 - 160 - 165 - 180, MINI, MYTHOS 110, SERIE 60 E 80, VIGNETO, VIGNETO CABINATO, VIGNETO FOOT-STEP	3648190M92
60273	12	2,6	10		BLIZZARD, FRUTTETO CABINATO, FRUTTETO FOOT-STEP, GLOBUS, GLOBUS 55, GLOBUS 55 TOP, GLOBUS RP30 - RP20, REX 60 F-L-V, REX 65 V, TREKKER, VIGNETO CABINATO, VIGNETO FOOT-STEP	3650746M91
10801	12	3,5	9	LAVERDA	3400 - 3400R, 3790 - 3790R, 3850 - 3850R, 3890 - 3890R, L521, L523 INTEGRALE, L523 MCS, L524, L525 INTEGRALE, L525 MCS, L624, L625, TL 58 I	4807376
26490	12	2,7	9		3400 - 3400R	4807373
26491	12	3	9		3300 - 3300R, 3500 - 3500R, 3550 - 3550AL, 3550R, 3650 - 3650R, 3750 - 3750R	4807375
41132	12	2,1	10	MASSEY FERGUSON	135, 155, 158, 240, 250, 255, 340, 342, 350, 352, 355, MF35	3597426M3, 3597426R3
41134	12	2,8	10		1014, 1080, 1114, 1134, 1200, 1250, 165, 168, 174, 175, 178, 185, 188, 194, 265, 273, 274, 275, 283, 284, 285, 290, 293, 294, 298, 3050, 3060, 3065, 3070, 362, 365, 373, 374, 375, 377, 383, 384, 387, 390, 393, 394, 397, 398, 399, 4225, 4235, 4240, 4245, 4255, 4260, 4270, 565, 575, 590, 592, 595, 6110, 6120, 6130, 6140, 6150, 675, 690, 698, 699	3539390M91, 3539390M92, 3763362M91
41138	12	2,8	10		165, 355, 360, 560, 65, 765, MF 550	3763363M91, 3763363M92
41213	12	2,8	10		2620, 2625, 2640, 2645, 2680, 2685, 2720, 2725, 3080, 3090, 3610, 3630, 3650, MF2620	1618050M3, 1618050M4, 1618050R4, 1903145M91, 3637269R91
43032	12	2,8	10		130, 145, 2620, 2640, 2645, 2675, 2680, 2685, 2705, 2725, 3085 - 3095 - 3115 - 3125, 3645 - 3655, MF1004	1446802M91, 3581576M1, 3581576R1, 3630508R1, 3648191M92
22046	12	2,8	10	NEW HOLLAND	L781 - L783 - L785, TC52 - TC54 - TC56, TW5-10-15-25-35	83981923, D8NN11000CE
26490	12	2,7	9		55.85V-60.65M-55.65F-55.65M, 60.75V-60.65V-60.85F-55.85F, 62.85-55.65V-60.75M-55.85M, 62.85M-60.75-60.65-60.85V, L60-L65-L75-L85-L95, SB52 - SB54 BRAUD VENDEMMIATRI, TD55D - TD60D - TD65D, TD60 - TD70, TD65B, TD65F - TD75F - TD85F, TD70 - TD80 - TD90 - TD95, TD70-TD90-TD80-TD60-TD95, TD70D - TD75D, TK65V - TK70FA - TK70VA, TK75F - TK75FA, TK75M - TK75MA, TK75V - TK75VA, TL65A, TL65F-TL55F-TL75F, TL70-TL80-TL65-TL90-TL100, TN55 - TN55D - TN55S - TN55V, TN60A - TN60DA, TN60SA - TN60VA, TN65 - TN65D, TN65N - TN65S - TN65V, TN70 - TN70A - TN70D - TN70DA, TN70NA - TN70S, TN70SA - TN70VA, TN75 - TN75A - TN75D - TN75DA, TN75N - TN75NA, TN75S - TN75SA, TN75V - TN75VA, TT65D	4807373, 500338953

Art./Ref.	Volt/Volt	Kw/Kw	N° denti/Teeth n°	Brand	Applicazione/Application	Rif. Orig./Orig. Ref.
26491	12	3	9	NEW HOLLAND	70.75M-70.65M-80.75-80.65, 72.85-70.65-72.85M-, 88.85M-70.75-82.85M-80.66DT, L60-L65-L75-L85-L95, TD60-TD70-TD80-TD90-TD95, TD75D - TD80D - TD90D - TD95D, TK100A, TK80A - TK80MA, TK90A - TK90MA, TL55F-TL65F-TL75F, TL65-TL70-TL80-TL90-TL100, TL65A, TN75FA - TN85FA - TN95FA, TN95NA - TN95VA	4807375, 504059251
60275	12	3	10		555E - 575E - 655E - 675E, 75TLB - 85TLB - 95TLB, LB110, LB115 - LB115.B - LB115CP, LB75.B - LB85 - LB90 - LB95, TM115-125-150-165, TS100 - TS110 - TS115, TS80 - TS90, TS80-90-110-115, TV140	82007917, 87755550
53287	12	3,1	9	RENAULT	CERES85-95, R351-421-456-460-461-462, R480-486-489-490-498, R50-51-53-551-556-56-60-61, R651-652	-
60268	12	3,1	10		ARES 610, ARES 620, ARES 630, ARES 640	7700044450, 7700045291
51732	12	3	11	SAME	ALSTER60, ANTARES110-130, BUFFALO130, CENTAURO70-EXPORT70, CONDOR55-CROP85-DRAGO120, EXPLORER55-65-65C-75-85, FRUTTE-T060-75-2RM-75DT, GALAXY170-HERCULES160, JAGUAR95-100-105, LASER100,110-130-150-90, LEOPARD85-85EXPORT-90TURBO, LEOPARD90 TURBO C, MERCURY85-85EXPORT-85SPECIAL, MOMOTAIRIS60, PANTHER90-95, RANGER45-SOLAR60-TAURUS60-60C, SPECIAL CENTURION 75 SPECIAL, SPECIAL CENTURION55-70-75-75EX, TIGER100-SIX105-TITAN160, TITAN190-195, TRANSPORT85, VIGNERON50-60-70	2.9619.180.0, 2.9619.400.0, 2.9619.562.0
53285	12	3	9		ANTARES110,130,150, DORADO70, EXPLORER70,80,90, FRUTTE-T075.85, GALAXY170, LASER110,130,150, SILVER80,90,100,90TURBO	2.9619.230.0, 2.9619.290.0/10, 2.9619.380.0, 2.9619.390.0, 2.9619.560.0
51732	12	3	11	STEYR	1100, 1108, 1200, 288, 290, 406, 50, 650A, 658A, 760 SUPER, 760A, 768A, 988	-
51733	12	3	9		8055, 8060, 8070, 8075, 8080, 8090, 950, 960	-
53284	12	2,7	9		8055, 8055A, 8060, 8060A, 8060TA, 8065A	-
53285	12	3	9		8100, 8110, 8120, 8130, 8140, 8150, 8170	-
53286	12	3	9		1100, 1108, 1200, 1400, 8140, 8150, 8160, 8165, 8170, 980, 988	-
41134	12	2,8	10	VALTRA	255, 355, 365, 465, 504, 505, 565, 604, 605, 665, 800, 805, 865, 900, C100, C15, C20, C200	-
60256	24	4	11		SK150	-
51734	12	3	10	JOHN DEERE	1020, 1030, 1040, 1065, 1075, 1075H, 1075H (BIS 1987), 1085, 1120, 1130, 1140, 1530, 1630, 1640, 1830, 1840, 2020, 2030, 2040, 2120, 2130, 2140, 2250, 2450, 2650, 2850, 2940, 3030, 3040, 3050, 3120, 3130, 3140, 330, 3350, 3650, 430, 510, 530, 6010-6100-6110, 6200-6210-6300-6310-6400-6410, 630, 710, 730, 820, 830, 840, 920, 925, 930, 932, 935, 940, 942, 945, 950, 952, 955, 960, 965, 968H, 970, 975	AL110597, AL41247, AR70436

**RUOTE DENTATE ADATTABILI**

ROUES DENTEES ADAPTABLE  
RING GEAR ADAPTABLE  
ZAHRAEDER PASSEND ZU  
RUEDAS DENTADAS ADAPTABLE

Art./Ref.	Note/Note	Brand	Rif. Orig./Orig. Ref.
10646	Ruota dentata 110 denti IDM 325 mm - Ring gear teeth 110 IDM 325 mm	FIAT	4602143
19054	Ruota dentata 128 denti IDM 372 mm - Ring gear teeth 128 IDM 372 mm	FORD	83949153, E2N-N6384AA
40185	Ruota dentata - Ring gear Ruota dentata 132 denti adatta a - Ring gear teeth 132 suitable: 2620-2640-2645-2685-2720-2725-3080-3085-3090-3095-3115-3120-3140-3160-3610-3630-3535-3645-3650-3655-3660-3670-3680-6170-6180-6190-8110-8120-8130-8140/Ring gear 132 teeth adaptable to: 2620-2640-2645-2685-2720-2725-3080-3085-3090-3095-3115-3120-3140-3160-3610-3630-3535-3645-3650-3655-3660-3670-3680-6170-6180-6190-8110-8120-8130-8140	MASSEY FERGUSON	0410236, 3552228M1, 731008M1
40194	Ruota dentata - Ring gear Ruota dentata 132 denti adatta a - Ring gear teeth 132 suitable: 2620-2640-2645-2685-2720-2725-3080-3085-3090-3095-3115-3120-3140-3160-3610-3630-3535-3645-3650-3655-3660-3670-3680-6170-6180-6190-8110-8120-8130-8140/Ring gear 132 teeth adaptable to: 2620-2640-2645-2685-2720-2725-3080-3085-3090-3095-3115-3120-3140-3160-3610-3630-3535-3645-3650-3655-3660-3670-3680-6170-6180-6190-8110-8120-8130-8140		1619032M1, 741138M1



**ALTERNATORI ADATTABILI**

ALTERNATEURS ADAPTABLE

ALTERNATORS ADAPTABLE

STROMWECHSLER PASSEND ZU

ALTERNADORES ADAPTABLE

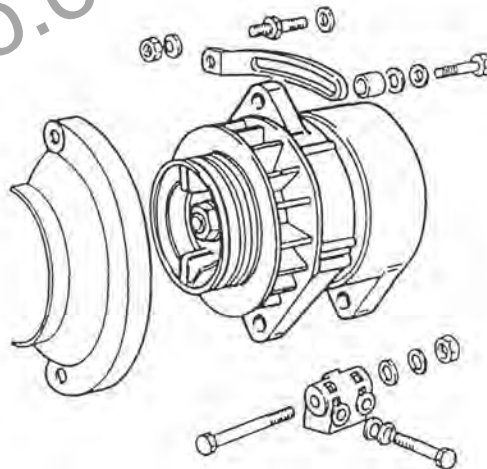

Art./Ref.	Volt/Volt	Ampere/Ampere	Brand	Applicazioni/Application	Rif. Orig./Orig. Ref.
<b>10782</b>	12	45 senza regolatore	<b>FIAT</b>	FIAT SERIE ORO	4222697
<b>10786</b>	14	45 con regolatore		45.66 - 45.66 DT, 45.66S - 45.66S DT, 50.66 - 50.66 DT, 50.66S - 50.66S DT, 50.86S V - 50.86S V DT, 50.86V - 50.86V DT, 55.66 - 55.66 DT, 55.66S - 55.66S DT, 55.85 F-M-V, 55.88 - 55.88 DT, 55.90 - 55.90 DT, 56.66S - 56.66S DT, 60.56 DT, 60.66S - 60.66S DT, 60.85 F-V, 60.88 - 60.88 DT, 60.90 - 60.90 DT, 60.93 - 60.93 DT, 60.94 - 60.94 DT, 62.85 - 62.85 M, 62.86F - 62.86F DT, 65.66S - 65.66S DT, 65.88 - 65.88 DT, 65.90 - 65.90 DT, 65.93 - 65.93 DT, 65.94 - 65.94 DT, 70.56 - 70.56 DT, 70.66S - 70.66S DT, 70.88 - 70.88 DT, 70.90 - 70.90 DT, 72.85 - 72.85 M, 72.93 - 72.93 DT, 72.94 - 72.94 DT, 80.66S - 80.66S DT, 80.90 - 80.90 DT, 82.85 M, 82.93 - 82.93 DT, 82.94 - 82.94 DT, 85.55, 85.90 - 85.90 DT, 88.85 M, 88.93 - 88.93 DT, 88.94 - 88.94 DT, SERIE 66, SERIE 88, SERIE 90, SERIE 93, SERIE 94	4720502, 4787598, 4808498
<b>10788</b>	14	65 con regolatore		140.90, 160.90, 180.90, F100 - F100 DT, F110 - F110 DT, F115 - F115 DT, F120 - F120 DT, F130 - F130 DT, F140 - F140 DT	4808510, 4808511
<b>21708</b>	12	33 con regolatore		45.66 - 45.66 DT, 45.76 V, 50.66 - 50.66 DT, 50.86S V - 50.86S V DT, 50.86V - 50.86V DT, 55.46 - 55.46 DT, 55.56 - 55.56 DT, 55.65 F-M-V, 55.66 - 55.66 DT, 55.66 LP - 55.66 LP DT, 55.66F - 55.66F DT, 55.66S - 55.66S DT, 55.66V - 55.66V DT, 55.75 F-M-V, 55.76F - 55.76F DT, 55.76V - 55.76V DT, 55.85 F-M-V, 60.46 - 60.46 DT, 60.56 DT, 60.65 M-V, 60.66 - 60.66 DT, 60.66F - 60.66F DT, 60.66LP - 60.66LP DT, 60.66S - 60.66S DT, 60.75 M-V, 60.76F - 60.76F DT, 60.85 F-V, 62.85 M, 62.86F - 62.86F DT, 65.46 - 65.46 DT, 65.66 - 65.66 DT, 65.66S - 65.66S DT, 70.56 - 70.56 DT, 70.65 M, 70.66 - 70.66 DT, 70.66 V, 70.66F - 70.66F DT, 70.66LP - 70.66LP DT, 70.66S - 70.66S DT, 70.75 M, 70.76 V, 70.76F - 70.76F DT, 70.76LP - 70.76LP DT, 72.85 - 72.85 M, 72.85 M, 80.65, 80.66 - 80.66 DT, 80.66F - 80.66F DT, 80.66S - 80.66S DT, 80.75, 80.76F - 80.76F DT, 80.88 - 80.88 DT, 82.85 M, 88.85 M, SERIE ORO	4762563, 4998353, 5101645, 9972269
<b>10782</b>	12	45 senza regolatore	<b>FORD</b>	2310, 2600, 2910, 3000, 3600, 3910, 4000, 4100, 4610, 5600, 5610, 5700, 6600, 6700, 6710, 7000, 7810, 7910, 8210	83961474
<b>10786</b>	14	45 con regolatore		3435, 3830, 3935, 4030, 4135, 4230, 4430, 4635, 4835, 5635, 6635, 7635	4808498
<b>10788</b>	14	65 con regolatore		8430, 8630, 8830	4808511
<b>21708</b>	12	33 con regolatore		3010S, 3435, 3830, 3935, 4010S, 4030, 4135, 4230, 4430, 5010S	4762563, 4998353, 5101645, 9972269
<b>41155</b>	14	55 con regolatore		2310, 2600, 2910, 3600, 3910, 4000, 4100, 4610, 5600, 5610, 5700, 6600, 6700, 6710, 7000, 7810, 7910, 8210	83909615
<b>10786</b>	14	45 con regolatore	<b>LAVERDA</b>	3300 - 3300R, 3400 - 3400R, 3550AL, 3650 - 3650R, 3750 - 3750R	4808498
<b>10788</b>	14	65 con regolatore		3550AL - 3560AL, 3790 - 3790R, 3850 - 3850R, 3890 - 3890R, 8430, L518 - L520	4808511
<b>21708</b>	12	33 con regolatore		3400 - 3400R	4762563, 4998353, 5101645, 9972269
<b>10786</b>	14	45 con regolatore	<b>NEW HOLLAND</b>	L60 - L65 - L75 - L85 - L95, SERIE L-TK-TL, TK65F - TK65V, TK75F - TK75M - TK75V, TK76 - TK76M, TK85 - TK85M, TK95M, TL65 - TL70 - TL80, TL90 - TL100	4808498
<b>41141</b>	12	45	<b>PERKINS</b>	MOTORI PERKINS 6.354.4, MOTORI PERKINS D3.1525, MOTORI PERKINS T6354.4	2871A120
<b>41155</b>	14	55 con regolatore		MOTORI PERKINS 4.236, MOTORI PERKINS 4.248, MOTORI PERKINS 6.354.1, MOTORI PERKINS T3.152	2871A141

# 1.7.12 Guarnizioni e Paraolio

Gaskets and seals



**Ricambi & accessori per macchine agricole**  
SPARE PARTS & ACCESSORIES FOR AGRICULTURAL MACHINE

Tutti gli articoli della presente sezione, prodotti da AMA SPA e/o da terzi per conto di AMA, sono adattabili ("non originali") alle marche indicate ai sensi di quanto previsto dal REG. CE n. 1400/2002. I diritti sui marchi citati appartengono ai legittimi proprietari e il loro uso ha l'esclusiva finalità di consentire all'utilizzatore la comparazione dei diversi prodotti. All items of this section, manufactured by AMA SPA and/or any third party on behalf of AMA, are adaptable ("non-original") to the brands listed under the provisions of the REG. CE n. 1400/2002. The rights on the trademarks belong to their respective owners and their usage is only aimed to allow the user to compare different products.

**CAPPELLOTTI VALVOLA ADATTABILI MOTORI LOMBARDINI**

BOUCHONS SOUPAPE ADAPTABLE MOTEURS LOMBARDINI  
 VALVE CAPS ADAPTABLE LOMBARDINI ENGINES  
 VENTILKAPPE PASSEND ZU LOMBARDINI-MOTOREN  
 TAPAS VÁLVULA ADAPTABLE MOTORES LOMBARDINI

Art./Ref.	Brand	Applicazione/Application	Rif. Orig./Orig. Ref.
01184	LOMBARDINI	6LD360-325, LDA500-520-530, LDA904-914	2135.072
01186		3LD450-510, LDA450-510	2135.068
01188		4LD640-705-820, LDA96-97-100-820	2135.067
84374		5LD675/2-825/2-825/3, LDA672-832-833	2135.063

**ANELLI DI TENUTA TUBO ASTA PUNTERIE ADATTABILI LOMBARDINI**

BAGUES ADAPTABLE LOMBARDINI  
 RINGS ADAPTABLE LOMBARDINI  
 DICHTUNGSRINGE FÜR VENTILSTÖSSEL PASSEND ZU LOMBARDINI  
 ARANDELA DE COMPRESIÓN TUBO VÁSTAGO EMPUJADOR ADAPTABLE LOMBARDINI

Art./Ref.	Brand	Applicazione/Application	Rif. Orig./Orig. Ref.
01198	LOMBARDINI	LD GAD360-325 T/INFERIORE	4740.018
01199		3LD450,510-LDA450,510, 4LD640,705,820, LDA96,97,100,820-LA400	4740.017
01269		LDA672,673,674,832,833,834	1261.046
84375		LDA904-914	4740.022

**SERIE GUARNIZIONI ADATTABILI MOTORI LOMBARDINI**

POCHETTE DE JOINTS ADAPTABLE MOTEURS LOMBARDINI  
 GASKET SET ADAPTABLE LOMBARDINI ENGINES  
 DICHTUNGSSÄTZE PASSEND ZU LOMBARDINI-MOTOREN  
 SERIE DE CRIBAS ADAPTABLE MOTORES LOMBARDINI



**Note:** \* = Serie motore completa di gommino tubo asta punteria e gommino cappello valvole e o-ring.

**Notes:** \* = Engine line, complete with rubber hose, push rod & inlet valve seal.

Art./Ref.	Note/Note	Brand	Applicazione/Application	Rif. Orig./Orig. Ref.
01917	Serie motore */Engine line *	LOMBARDINI	3LD450,510-LDA450,510	8185.001
08163	Serie motore */Engine line *		LA 490	8180.018, 8180.181
08164	Serie motore */Engine line *		LDA 520	8180.047
08168	Serie motore */Engine line *		LDA 672	8180.028
08217	Serie motore */Engine line *		4LD705-LDA100	8180.027
08220	Serie motore */Engine line *		3LD450,510-LDA450,510	8180.033
08224	Serie motore */Engine line *		LDA 530	8180.055
08218	Serie smeriglio */Smeriglio line *		4LD705-LDA100	8185.002
08222	Serie smeriglio */Smeriglio line *		LDA672,673,674-D.95	8185.004
08223	Serie smeriglio */Smeriglio line *		LDA520-6LD325-D.78	8185.010
08225	Serie smeriglio */Smeriglio line *		LDA530-6LD360-D.82	8185.011

**GUARNIZIONI VARIE ADATTABILI MOTORI ACME**

JOINTS ADAPTABLE MOTEURS ACME

SEALING ADAPTABLE ACME ENGINES

DICHTUNGEN PASSEND ZU ACME-MOTOREN

VARIAS CRIBAS ADAPTABLE MOTORES ACME



Art./Ref.	Brand	Applicazione/Application	Rif. Orig./Orig. Ref.
08210	ACME	AL 480	A2336
08211		VT88-94	A2103
08212		ALN215-290-330	A2413

**GUARNIZIONI VARIE ADATTABILI MOTORI INTERMOTOR**

JOINTS ADAPTABLE MOTEURS INTERMOTOR

GASKET SET ADAPTABLE INTERMOTOR ENGINES

DICHTUNGEN PASSEND ZU INTERMOTOR MOTOREN

VARIAS CRIBAS ADAPTABLE MOTORES INTERMOTOR



Art./Ref.	Brand	Applicazione/Application	Rif. Orig./Orig. Ref.
08160	INTERMOTOR	IM300-301	8180.058, 8180.187
08161		IM350-351-352-252-302	8180.059, 8180.188

**ANELLI PARAOLIO ADATTABILI**

JOINT HUILE ADAPTABLE

OIL GASKET ADAPTABLE

ÖLDICHTUNGEN PASSEND ZU

JUNTA ADAPTABLE

Art./Ref.	Ø Interno mm/ Inside Ø mm	Ø esterno mm/ Outside Ø mm	Altezza mm/ Height mm	Note/Note	Brand	Applicazione/Application	Rif. Orig./ Orig. Ref.	Immagine/Image
<b>08498</b>	56	70	8/10	Guarnizione tenuta olio del corpo differenziale - Oil gasket for differential Type V4 173	<b>FIAT</b>	SERIE 90	40002710, 5105969, 5121471	
<b>14034</b>	45	65	15	Guarnizione tenuta olio del corpo differenziale - Oil gasket for differential Type COMBI SF1		100.90, 115.90, 130.90, 140.90, 160.90, 180.90	40002580, 5105944, 5135990	
<b>14605</b>	40	62	10	Guarnizione tenuta olio del corpo tipo BASL/Oil gasket for differential type BASL		SERIE 66, SERIE 90	27342232, 40002350, 4590419, 5105952, 5136002, 546690	
<b>08508</b>	45	65	10	Guarnizione tenuta olio per il cambio - Oil gasket for gearbox Tipo - Type B1		55.46-60.46-60.56-70.56	40000370, 40000371	
<b>15521</b>	50	68	8	Guarnizione tenuta per olio cambio Tipo B1KLRD / Oil gasket for gearbox type B1KLRD		100/90, 90/90	40003020, 5106069	
<b>14870</b>	25	31	7	Guarnizione tenuta olio per il cambio tipo BAOF / Oil gasket for gearbox type BAOF		SERIE 66, SERIE 88, SERIE 90	4985295	
<b>10666</b>	90	120	13	Guarnizione tenuta olio per semiasse anteriore - Oil gasket for front semi-axle Tipo - Type COMBI		SERIE 66, SERIE 88, SERIE 90	5116707, 5135387	



Art./Ref.	Ø Interno mm/ Inside Ø mm	Ø esterno mm/ Outside Ø mm	Altezza mm/ Height mm	Note/Note	Brand	Applicazione/Application	Rif. Orig./ Orig. Ref.	Immagine/Image
14358	42	62	17	Guarnizione tenuta olio per semiasse anteriore Tipo COMBI /Oil gasket for front semi axle Type COMBI SF1	FIAT	SERIE 66, SERIE 90	40002520, 5105923	
14917	55	70	8 LE	Guarnizione tenuta olio per corpo sollevatore Tipo BABSL /Oil gasket for lower link hydraulics Type BABSL		100.90, 60/90, 70/90, 80/90, 90/90, SERIE 66, SERIE 76, SERIE 88	40002170, 5105903, 5159078	
26439	35	55	12 LE	Guarnizione tenuta olio per riduttori laterali Tipo B1/ Oil gasket for reduction transmission Type B1		55.46 55.46DT, 60/46, 65/46	40000382, 40000384, 4951063	
14034	65	45	15	Guarnizione tenuta olio del corpo diffe enziale - Oil gasket for diffe ential Tipo - Type COMBI SF1	FORD	SERIE 8160, SERIE 8360, SERIE 8560	5135990	
08498	70	56	8/10	Guarnizione tenuta olio del corpo diffe enziale - Oil gasket for diffe ential Tipo - Type V4 173	NEW HOLLAND	SERIE L-M-F-TD-TL-TM-TS	5105969, 5121471	
14034	65	45	15	Guarnizione tenuta olio del corpo diffe enziale - Oil gasket for diffe ential Tipo - Type COMBI SF1		F140, M135, M160, TM140	5135990	
14605	62	40	10	Guarnizione tenuta olio del corpo tipo BASL/Oil gasket for diffe ential type BASL		SERIE L, SERIE TD, SERIE TL, SERIE TM, SERIE TS	5105952, 5136002	
10666	120	90	13	Guarnizione tenuta olio per semiasse anteriore - Oil gasket for front semi-axle Tipo - Type COMBI		SERIE L, SERIE TD, SERIE TL, SERIE TN	5116707, 5135387	

Art./Ref.	Ø Interno mm/ Inside Ø mm	Ø esterno mm/ Outside Ø mm	Altezza mm/ Height mm	Note/Note	Brand	Applicazione/Application	Rif. Orig./ Orig. Ref.	Immagine/Image
<b>14358</b>	62	42	17	Guarnizione tenuta olio per semiasse anteriore Tipo COMBI / Oil gasket for front semi axle Type COMBI SF1	<b>NEW HOLLAND</b>	SERIE F, SERIE M, SERIE TD, SERIE TS	5105923	
<b>15521</b>	68	50	8	Guarnizione tenuta per olio cambio Tipo B1KLRD / Oil gasket for gearbox type B1KLRD		SERIE L, SERIE TL	5106069	
<b>14033</b>	25	38	-	Anelli Paraolio - Oil Gasket	<b>FIAT</b>	45-66 DT, 45-76 V, 50-66, 50-86 V, 55-66 DT, 55-66 S, 55-76 F, 55-86 F, 55-88 DT, 55-90 DT, 60-66 DT, 60-76 F, 60-86 F, 60-88 DT, 60-90 DT, 60-93 DT, 60-94 DT, 62-86 F, 65-66 DT, 65-88 DT, 65-90 DT, 65-93 DT, 65-94 DT, 70-66 DT, 70-76, 70-86 V, 70-88 DT, 70-90 DT, 72-86 F, 72-93 DT, 72-94 DT, 80-66 DT, 80-76 F, 80-88 DT, 80-90 DT, 82-86 F, 82-93 DT, 82-94 DT, 85-90 DT, 88-93 DT, 88-94 DT	47124792, 5121123	
<b>14377</b>	35	49	-	Anelli Paraolio - Oil Gasket		115.90DT, 130.90DT, 140.90DT, 160.90DT, 180.90DT	5114000, 5131746	
<b>14649</b>	30	43,7	-	Anelli Paraolio/ Oil Gasket		100.90DT-110.90DT-90.90DT	5127037	
<b>14033</b>	25	38	-	Anelli Paraolio - Oil Gasket	<b>FORD</b>	3435, 3830, 3935, 4030, 4135, 4230, 4430, 4635, 4835, 5635, 6635	47124792, 5121123	
<b>14377</b>	35	49	-	Anelli Paraolio - Oil Gasket		8160, 8260, 8360	5114000, 5131746	
<b>14649</b>	30	43,7	-	Anelli Paraolio/ Oil Gasket		7635	5127037	
<b>14033</b>	25	38	-	Anelli Paraolio - Oil Gasket	<b>NEW HOLLAND</b>	L 60, L 65, L 75, L 85, L 95, TL 100, TL 70, TL 80, TL 90, TN 55, TN 65, TN 70, TN 75, TN 80 F, TN 90 F, TN 95 F	47124792, 5121123	
<b>14377</b>	35	49	-	Anelli Paraolio - Oil Gasket		D110DT, D115 DT, F100 DT, F120, F130DT, F140DT, M100, M115, M135, TM115, TM120, TM125, TM130	5114000, 5131746	
<b>14649</b>	30	43,7	-	Anelli Paraolio/ Oil Gasket		L60 - L65, L65, L 75, L85, L95, TL100, TL70, TL80, TL90	5127037	

## 1.7.13 Strumenti parti elettriche

Tools, electrical parts



**ama**

**Ricambi & accessori per macchine agricole**  
SPARE PARTS & ACCESSORIES FOR AGRICULTURAL MACHINE

Tutti gli articoli della presente sezione, prodotti da AMA SPA e/o da terzi per conto di AMA, sono adattabili ("non originali") alle marche indicate ai sensi di quanto previsto dal REG. CE n. 1400/2002. I diritti sui marchi citati appartengono ai legittimi proprietari e il loro uso ha l'esclusiva finalità di consentire all'utilizzatore la comparazione dei diversi prodotti. All items of this section, manufactured by AMA SPA and/or any third party on behalf of AMA, are adaptable ("non-original") to the brands listed under the provisions of the REG. CE n. 1400/2002. The rights on the trademarks belong to their respective owners and their usage is only aimed to allow the user to compare different products.

**QUADRO STRUMENTO ADATTABILE FIAT**

TABLEAU DE BORD ADAPTABLE FIAT  
 INSTRUMENT PANEL ADAPTABLE FIAT  
 INSTRUM.TAFEL PASSEND ZU FIAT  
 PANEL DE INSTRUMENTOS ADAPTABLE FIAT



Art./Ref.	Brand	Applicazione/Application	Rif. Orig./Orig. Ref.
<b>10619</b>	<b>FIAT</b>	450, 480, 500, 540, 550, 600, 640, CINGOLATI SERIE ORO	4334915, 4335525

**INDICATORE TEMPERATURA ACQUA ADATTABILE**

TEMPERATURE EAU ADAPTABLE  
 WATER TEMPERATURE GAUGE ADAPTABLE  
 KÜHLWASSERANZEIGE PASSEND ZU  
 MEDIDOR DE TEMPERATURA DEL AGUA ADAPTABLE



Art./Ref.	Brand	Applicazione/Application	Rif. Orig./Orig. Ref.
<b>41964</b>	<b>FIAT</b>	450, 480, 500, 540, 550, 600, 640, CINGOLATI SERIE ORO	4334917
<b>41964</b>	<b>LANDINI</b>	10000, 12500, 13000, 14500, 5500, 5830( DA 221R03297), 5830(FINO A 221R03296), 5840, 6030, 6040, 6500, 6550, 6830(DA 221S04456), 6830(FINO A 221S04455), 6840, 7500, 7550, 7830( DA 220L01505), 7830(FINO A 220L01504), 8500, 8550, 8830( DA 223H02262), 8830(FINO A 223H02261), ATLAS:100, ATLAS:70, ATLAS:75, ATLAS:80, ATLAS:85, ATLAS:90, CINGOLATI:C4500, CINGOLATI:C4830, CINGOLATI:C5500, CINGOLATI:C5830, CINGOLATI:C6500, CINGOLATI:C6830, CINGOLATI:C7800, CINGOLATI:C7830, CINGOLATI:C8860, CINGOLATI:CF4830, CINGOLATI:CF5030, CINGOLATI:CF5830, CINGOLATI:CF6030, CINGOLATI:CF6060, CINGOLATI:CF6830, FRUTTETI 530 F/L:5530F/L, FRUTTETI 530 F/L:6530F/L, FRUTTETI 530 F/L:7530F/L, FRUTTETI 530 F/L:8530L, FRUTTETI 530F:8530F, FRUTTETI 530V:4530V, FRUTTETI 530V:5530V, FRUTTETI 530V:6030F/L/V, FRUTTETI 530V:6530V, REX CAB E F.S: 100, REX CAB E F.S: 60, REX CAB E F.S: 70, REX CAB E F.S: 90, REX CAB E F.S:80, VIGNETI REX CAB:60V, VIGNETI REX CAB:65V, VIGNETI REX CAB:70V, VIGNETI REX CAB:80V	3305408M93, 3654640M91
<b>41964</b>	<b>MASSEY FERGUSON</b>	1004 T, 1014 - 1024 - 1114 - 1134, 134 V, 154 F, 154 S, 154 V, 164 T F, 164 T S, 164 T V, 174 F, 174 S, 174 V, 184 F, 184 S, 194 F, 194 S, 233, 234 CF, 244 CF, 253, 254 CF, 263 T, 264 T, 264 T F, 264 T S, 273, 274 C, 274 CF, 274 SK, 283, 284, 293, 294, 294 C, 294 S, 364 CF, 394 C, 675, 690, 698, 698 T, 699	3305408M91, 3305408M92, 3305408M93

**CONTAORE-CONTAGIRI ADATTABILE FIAT**

COMPTE-HEURE ADAPTABLE FIAT  
 COUNTER ADAPTABLE FIAT  
 DREHZAHLMESSER PASSEND ZU FIAT  
 NÚMERO DE HORAS ADAPTABLE FIAT



Art./Ref.	Brand	Applicazione/Application	Rif. Orig./Orig. Ref.
10676	FIAT	450, 480, 500, 540, 550, 600, 640, CINGOLATI SERIE ORO	4180290, 4328998, 4334916

**INDICATORE CARBURANTE ADATTABILE FIAT**

INDICATEUR NIVEAU CARBURANT ADAPTABLE FIAT  
 FUEL GAUGE ADAPTABLE FIAT  
 KRAFTSTOFFANZEIGER PASSEND ZU FIAT  
 MEDIDOR DE COMBUSTIBLE ADAPTABLE FIAT



Art./Ref.	Brand	Rif. Orig./Orig. Ref.
10624	FIAT	4180589, 4243893, 4998701, 5199933

**QUADRO STRUMENTO ADATTABILE FIAT**

TABLEAU DE BORD ADAPTABLE FIAT  
 INSTRUMENT PANEL ADAPTABLE FIAT  
 INSTRUM.TAFEL TYP PASSEND ZU FIAT  
 PANEL DE INSTRUMENTOS ADAPTABLE FIAT



Art./Ref.	Brand	Applicazione/Application	Rif. Orig./Orig. Ref.
10620	FIAT	45-66S, 45-66S - 45-66S DT, 50-66S - 50-66S DT, 50-86V - 50-86V DT, 50-86S V - 50-86S V DT, 55-56 - 55-56 DT, 55-66S - 55-66S DT, 55-86 F - 55-86 F DT, 55-86 V - 55-86 V DT, 55-86S V - 55-86S V DT, 56-66S - 56-66S DT, 60-56 DT, 60-66S - 60-66S DT, 60-86 F - 60-86 F DT, 60-86 V - 60-86 V DT, 60-86S V - 60-86S V DT, 62-86 F - 62-86 F DT, 65-56 - 65-56 DT, 65-66S - 65-66S DT, 70-56 - 70-56 DT, 70-66S - 70-66S DT, 70-86 V - 70-86 V DT, 70-86S V - 70-86S V DT, 72-86 F - 72-86 F DT, 72-86 LP - 72-86 LP DT, 82-86 F - 82-86 F DT, 82-86 LP - 82-86 LP DT	4997124, 5105878, 5133783, 5145186
10620	FORD	3435, 3830, 3935, 4030, 4135, 4230, 4430	5145186



# 1.7.14 Frizioni

Clutches



**ama**

**Ricambi & accessori per macchine agricole**

**SPARE PARTS & ACCESSORIES FOR AGRICULTURAL MACHINE**

Tutti gli articoli della presente sezione, prodotti da AMA SPA e/o da terzi per conto di AMA, sono adattabili ("non originali") alle marche indicate ai sensi di quanto previsto dal REG. CE n. 1400/2002. I diritti sui marchi citati appartengono ai legittimi proprietari e il loro uso ha l'esclusiva finalità di consentire all'utilizzatore la comparazione dei diversi prodotti.  
All items of this section, manufactured by AMA SPA and/or any third party on behalf of AMA, are adaptable ("non-original") to the brands listed under the provisions of the REG. CE n. 1400/2002. The rights on the trademarks belong to their respective owners and their usage is only aimed to allow the user to compare different products.

**KIT FRIZIONE ADATTABILE RIF. 9973691 AGRIFULL**

KIT EMBRAYAGE ADAPTABLE REF. 9973691 AGRIFULL

KIT CLUTCH ADAPTABLE REF. 9973691 AGRIFULL

KIT KUPPLUNG PASSEND ZU REF. 9973691 AGRIFULL

KIT EMBRAGUE ADAPTABLE REF. 9973691 AGRIFULL

Art./Ref.	Note/Note	Brand	Applicazione/Application	Rif. Orig./Orig. Ref.	Immagine/Image
<b>57940</b>	Kit composto da - Kit consists of: - Meccanismo/Clutch Ref. 5162900 With box Original CNH - Disco Pto/Disc Pto Ref. 5154703 Not Original - Cuscinetto/Bearing Ref. 5122028 Not Original - Cuscinetto/Bearing Ref. 24905360 Not Original	<b>AGRIFULL</b>	60 II F - 70 II F - 80 II F	9973691	   
<b>NH5162900</b>	Meccanismo Frizione 11" - Fiat originale		60 II F - 70 II F - 80 II F	47512400, 5162900	
<b>26988</b>	Disco Pto Diametro 280 mm - Pto Disc Diameter 280 mm		60 II F - 70 II F - 80 II F	5145715, 5154703	
<b>12841</b>	Cuscinetto reggispinta 90 x 50 x 21,60 mm / Thrust Bearing 90 x 50 x 21,60 mm			5122028	
<b>14882</b>	Cuscinetto pto 110 x 70 x 20 mm / Pto Bearing 110 x 70 x 20 mm		60 II F - 70 II F - 80 II F	24905360	
<b>84025</b>	Kit composto da - Kit consists of: - Meccanismo/Clutch Ref. 5162900 With box Original LUK - Disco Pto/Disc Pto Ref. 5154703 Not Original - Cuscinetto/Bearing Ref. 5122028 Not Original - Cuscinetto/Bearing Ref. 24905360 Not Original	<b>AGRIFULL</b>	60 II F - 70 II F - 80 II F	9973691	    
<b>07859</b>	Meccanismo Frizione 11" - Luk originale		60 II F - 70 II F - 80 II F	47512400, 5162900	 



Art./Ref.	Note/Note	Brand	Applicazione/Application	Rif. Orig./Orig. Ref.	Immagine/Image
26988	Disco Pto Diametro 280 mm - Pto Disc Diameter 280 mm	AGRIFULL	60 II F - 70 II F - 80 II F	5145715, 5154703	
12841	Cuscinetto reggispinta 90 x 50 x 21,60 mm / Thrust Bearing 90 x 50 x 21,60 mm			5122028	
14882	Cuscinetto pto 110 x 70 x 20 mm / Pto Bearing 110 x 70 x 20 mm		60 II F - 70 II F - 80 II F	24905360	

Art./Ref.	Note/Note	Brand	Applicazione/Application	Rif. Orig./Orig. Ref.	Immagine/Image
LUK628105310	Kit tutto originale LUK composto da - Kit all LUK original consists of: - Meccanismo/Clutch Ref. 228 0098 10 - Disco Pto/Disc Pto 328 0186 16 - Cuscinetto/Bearing Ref. 500 0459 00 - Cuscinetto/Bearing Ref. 500 0284 00 - Cuscinetto/Bearing Ref. 410 0025 00	AGRIFULL	60 II F - 70 II F - 80 II F	9973691	    
07859	Meccanismo Frizione 11" - Luk originale		60 II F - 70 II F - 80 II F	47512400, 5162900	
07852	Disco Pto Diametro 280 mm Luk originale - Pto Disc Diameter 280 mm Original Luk		60 II F - 70 II F - 80 II F	5145715, 5154703	
LUK500045900	Cuscinetto reggispinta 90 x 50 x 21,60 mm / Thrust Bearing 90 x 50 x 21,60 mm		60 II F - 70 II F - 80 II F, DERBY 60 - 80, GRISO 70 - 75, JOLLY 50, RODEO 90 - 95, TORNADO 80, TOSELLI 60 - 70 - 85, TOSELLI 8085 - 8095 - 8105	5122028	
LUK500028400	Cuscinetto pto 110 x 70 x 20 mm / Pto Bearing 110 x 70 x 20 mm		60 II F - 70 II F - 80 II F	24905360	
LUK410002500	Cuscinetto volano 47 x 17 x 14 mm - Bearing 47 x 17 x 14 mm		60 II F - 70 II F - 80 II F	28043280	

**KIT FRIZIONE ADATTABILE RIF. 9973696 AGRIFULL**

KIT EMBRAYAGE ADAPTABLE REF. 9973696 AGRIFULL

KIT CLUTCH ADAPTABLE REF. 9973696 AGRIFULL

KIT KUPPLUNG PASSEND ZU REF. 9973696 AGRIFULL

KIT EMBRAGUE ADAPTABLE REF. 9973696 AGRIFULL

Art./Ref.	Note/Note	Brand	Applicazione/Application	Rif. Orig./Orig. Ref.	Immagine/Image
57941	Kit composto da - Kit consists of: - Meccanismo/Clutch Ref. 5163936 With box Original CNH - Disco Pto/Disc Pto Ref. 5154514 Not Original - Cuscinetto/Bearing Ref. 5122028 Not Original - Cuscinetto/Bearing Ref. 5112084 Not Original	AGRIFULL	TOSELLI 8085 - 8095 - 8105	9973696	   
NH5163936	Meccanismo Frizione 12" - Fiat originale		TOSELLI 8085 - 8095 - 8105	5163936	
26990	Disco Pto Diametro 310 mm - Pto Disc Diameter 310 mm		TOSELLI 8085 - 8095 - 8105	5154514	
12841	Cuscinetto reggisinta 90 x 50 x 21,60 mm / Thrust Bearing 90 x 50 x 21,60 mm		55.46 - 55.66, 60 II/F/DT, 65.46, 70 II/F/DT, 80 II/F/DT, 8045 - 8050 - 8055, 8060 - 8065 - 8075, 8085 - 8095 - 8105, DERBY 60 - 80, GRISO 70 - 75, JOLLY 50, RODEO 90 - 95, TORNADO 80, TOSELLI 60 - 70 - 85	5122028	
15545	Cuscinetto pto 115 x 75 x 20 mm / Pto Bearing 115 x 75 x 20 mm		TOSELLI 8085 - 8095 - 8105	5112084	
84028	Kit composto da/Kit consists of: - Meccanismo/Clutch Ref. 5163936 With box Original LUK - Disco Pto/Disc Pto Ref. 5154514 Not Original - Cuscinetto/Bearing Ref. 5122028 Not Original - Cuscinetto/Bearing Ref. 5112084 Not Original	AGRIFULL	TOSELLI 8085 - 8095 - 8105	9973696	   
07864	Meccanismo Frizione 12" - Luk Originale		TOSELLI 8085 - 8095 - 8105	5163936	

Art./Ref.	Note/Note	Brand	Applicazione/Application	Rif. Orig./Orig. Ref.	Immagine/Image
26990	Disco Pto Diametro 310 mm - Pto Disc Diameter 310 mm	AGRIFULL	TOSELLI 8085 - 8095 - 8105	5154514	
12841	Cuscinetto reggispinta 90 x 50 x 21,60 mm / Thrust Bearing 90 x 50 x 21,60 mm		55.46 - 55.66, 60 II/F/DT, 65.46, 70 II/F/DT, 80 II/F/DT, 8045 - 8050 - 8055, 8060 - 8065 - 8075, 8085 - 8095 - 8105, DERBY 60 - 80, GRISO 70 - 75, JOLLY 50, RODEO 90 - 95, TORNADO 80, TOSELLI 60 - 70 - 85	5122028	
15545	Cuscinetto pto 115 x 75 x 20 mm / Pto Bearing 115 x 75 x 20 mm		TOSELLI 8085 - 8095 - 8105	5112084	
LUK631106810	Kit tutto originale LUK composto da - Kit all LUK original consists of: - Meccanismo/Clutch Ref. 231 0049 19 - Disco Pto/Disc Pto 331 0132 16 - Cuscinetto/Bearing Ref. 500 0459 00 - Cuscinetto/Bearing Ref. 500 1292 10 - Cuscinetto/Bearing Ref. 410 0026 00	AGRIFULL	TOSELLI 8085 - 8095 - 8105	9973696	    
07864	Meccanismo Frizione 12" - Luk Originale		TOSELLI 8085 - 8095 - 8105	5163936	
07866	Disco Pto Diametro 310 mm Luk originale - Pto Disc Diameter 310 mm Original Luk		TOSELLI 8085 - 8095 - 8105	5154514	
LUK500045900	Cuscinetto reggispinta 90 x 50 x 21,60 mm / Thrust Bearing 90 x 50 x 21,60 mm		60 II F - 70 II F - 80 II F, DERBY 60 - 80, GRISO 70 - 75, JOLLY 50, RODEO 90 - 95, TORNADO 80, TOSELLI 60 - 70 - 85, TOSELLI 8085 - 8095 - 8105	5122028	
LUK500129210	Cuscinetto pto 115 x 75 x 20 mm / Pto Bearing 115 x 75 x 20 mm		TOSELLI 8085 - 8095 - 8105	5112084	
LUK410002600	Cuscinetto volano 47 x 20 x 14 mm - Bearing 47 x 20 x 14 mm		TOSELLI 8085 - 8095 - 8105	28042740	

**KIT FRIZIONE LUK ADATTABILE RIF. 87689657 AGRIFULL**

KIT EMBRAYAGE LUK ADAPTABLE REF. 87689657 AGRIFULL

KIT CLUTCH LUK ADAPTABLE REF. 87689657 AGRIFULL

KIT KUPPLUNG LUK PASSEND ZU REF. 87689657 AGRIFULL

KIT EMBRAGUE LUK ADAPTABLE REF. 87689657 AGRIFULL

Art./Ref.	Note/Note	Brand	Applicazione/Application	Rif. Orig./Orig. Ref.	Immagine/Image
<b>LUK628103410</b>	Kit tutto originale LUK composto da - Kit all LUK original consists of: - Meccanismo/Clutch Ref. 228 0077 17 - Disco Pto/Disc Pto 328 0186 16 - Cuscinetto/Bearing Ref. 500 0459 00 - Cuscinetto/Bearing Ref. 500 0284 00 - Cuscinetto/Bearing Ref. 410 0025 00	<b>AGRIFULL</b>	TOSELLI 55.46 - 55.66, TOSELLI 60 - 70 - 85, TOSELLI 60 II F DT, TOSELLI 65.46, TOSELLI 70 II F DT, TOSELLI 80 II F DT, TOSELLI 8045 - 8050, TOSELLI 8050 - 8055, TOSELLI 8060 - 8075, TOSELLI DERBY 60 - 80, TOSELLI GRISO 70 - 75, TOSELLI JOLLY 50, TOSELLI RODEO 90 - 95, TOSELLI TORNADO 80	87689657	    
<b>07850</b>	Meccanismo Frizione 11" - Luk originale		TOSELLI 55.46 - 55.66, TOSELLI 60 - 70 - 85, TOSELLI 60 II F DT, TOSELLI 65.46, TOSELLI 70 II F DT, TOSELLI 80 II F DT, TOSELLI 8045 - 8050, TOSELLI 8050 - 8055, TOSELLI 8060 - 8075, TOSELLI DERBY 60 - 80, TOSELLI GRISO 70 - 75, TOSELLI JOLLY 50, TOSELLI RODEO 90 - 95, TOSELLI TORNADO 80	47512408, 5154879, 5171137	
<b>07852</b>	Disco Pto Diametro 280 mm Luk originale - Pto Disc Diameter 280 mm Original Luk		60 II F - 70 II F - 80 II F, TOSELLI 55.46 - 55.66, TOSELLI 60 - 70 - 85, TOSELLI 60 II F DT, TOSELLI 65.46, TOSELLI 70 II F DT, TOSELLI 80 II F DT, TOSELLI 8045 - 8050, TOSELLI 8050 - 8055, TOSELLI 8060 - 8075, TOSELLI DERBY 60 - 80, TOSELLI GRISO 70 - 75, TOSELLI JOLLY 50, TOSELLI RODEO 90 - 95, TOSELLI TORNADO 80	5145713, 5154703	
<b>LUK500045900</b>	Cuscinetto reggispinta 90 x 50 x 21,60 mm / Thrust Bearing 90 x 50 x 21,60 mm		60 II F - 70 II F - 80 II F, DERBY 60 - 80, GRISO 70 - 75, JOLLY 50, RODEO 90 - 95, TORNADO 80, TOSELLI 60 - 70 - 85, TOSELLI 8085 - 8095 - 8105	5122028	
<b>LUK500028400</b>	Cuscinetto pto 110 x 70 x 20 mm / Pto Bearing 110 x 70 x 20 mm		60 II F - 70 II F - 80 II F, TOSELLI 55.46 - 55.66, TOSELLI 60 - 70 - 85, TOSELLI 60 II F DT, TOSELLI 65.46, TOSELLI 70 II F DT, TOSELLI 80 II F DT, TOSELLI 8045 - 8050, TOSELLI 8050 - 8055, TOSELLI 8060 - 8075, TOSELLI DERBY 60 - 80, TOSELLI GRISO 70 - 75, TOSELLI JOLLY 50, TOSELLI RODEO 90 - 95, TOSELLI TORNADO 80	24905360	
<b>LUK410002500</b>	Cuscinetto volano 47 x 17 x 14 mm - Bearing 47 x 17 x 14 mm	60 II F - 70 II F - 80 II F, TOSELLI 55.46 - 55.66, TOSELLI 60 - 70 - 85, TOSELLI 60 II F DT, TOSELLI 65.46, TOSELLI 70 II F DT, TOSELLI 80 II F DT, TOSELLI 8045 - 8050, TOSELLI 8050 - 8055, TOSELLI 8060 - 8075, TOSELLI DERBY 60 - 80, TOSELLI GRISO 70 - 75, TOSELLI JOLLY 50, TOSELLI RODEO 90 - 95, TOSELLI TORNADO 80	28043280		

**KIT FRIZIONE ADATTABILE RIF. 9973691 CASE**

KIT EMBRAYAGE ADAPTABLE REF. 9973691 CASE

KIT CLUTCH ADAPTABLE REF. 9973691 CASE

KIT KUPPLUNG PASSEND ZU REF. 9973691 CASE

KIT EMBRAGUE ADAPTABLE REF. 9973691 CASE

Art./Ref.	Note/Note	Brand	Applicazione/Application	Rif. Orig./Orig. Ref.	Immagine/Image
<b>57940</b>	Kit composto da - Kit consists of: - Meccanismo/Clutch Ref. 5162900 With box Original CNH - Disco Pto/Disc Pto Ref. 5154703 Not Original - Cuscinetto/Bearing Ref. 5122028 Not Original - Cuscinetto/Bearing Ref. 24905360 Not Original	<b>CASE</b>	AVJ55, AVJ60, AVJ70, JX85, JX90, VJ60, VJ70, VJ80	9973691	
<b>NH5162900</b>	Meccanismo Frizione 11" - Fiat originale		AVJ55, AVJ60, AVJ70, JX85, JX90, VJ60, VJ70, VJ80	47512400, 5162900	
<b>26988</b>	Disco Pto Diametro 280 mm - Pto Disc Diameter 280 mm		JX85, JX90, VJ80	5145715, 5154703	
<b>12841</b>	Cuscinetto reggispira 90 x 50 x 21,60 mm / Thrust Bearing 90 x 50 x 21,60 mm		2140,2120,2130,2150, FARMALL 75C/55C/65C, JX1060V/C, JX1090U, JX1085C, JX1070C/V/U/N, JX1075C/N/V, JX1095V/C/N, JX1100U, JX1080U, JX70U, JX80U, JX55, JX55T, AVJ55, AVJ70, AVJ60, VJ80, JX60, JX80, JX95, JX75, JX65, JX85, JX90U, JX100U, QUANTUM 105F/N/V, QUANTUM 65C/95C/75C/85C, QUANTUM 85F/N/V, 95F/N/V, QUANTUM 95F/N/V, 75F/N/V, VJ70, VJ60, JX95, JX90, JX70, JX90	1966557C1, 4954935, 5122028, 5197980, 87345759, 87541562, B513160	
<b>14882</b>	Cuscinetto pto 110 x 70 x 20 mm / Pto Bearing 110 x 70 x 20 mm		AVJ55-AVJ60-AVJ70, JX100U-JX1070U-JX1080U, JX1090U-JX1100U, JX70U-JX80U-JX90U, VJ60-VJ70-VJ80	24905360	
<b>84025</b>	Kit composto da/Kit consists of: - Meccanismo/Clutch Ref. 5162900 With box Original LUK - Disco Pto/Disc Pto Ref. 5154703 Not Original - Cuscinetto/Bearing Ref. 5122028 Not Original - Cuscinetto/Bearing Ref. 24905360 Not Original	<b>CASE</b>	AVJ55, AVJ60, AVJ70, JX85, JX90, VJ60, VJ70, VJ80	9973691	
<b>07859</b>	Meccanismo Frizione 11" - Luk originale		AVJ55, AVJ60, AVJ70, JX85, JX90, VJ60, VJ70, VJ80	47512400, 5162900	

Art./Ref.	Note/Note	Brand	Applicazione/Application	Rif. Orig./Orig. Ref.	Immagine/Image
26988	Disco Pto Diametro 280 mm / Pto Disc Diameter 280 mm		JX85, JX90, VJ80	5145715, 5154703	
12841	Cuscinetto reggispinta 90 x 50 x 21,60 mm / Thrust Bearing 90 x 50 x 21,60 mm	CASE	2140, 2120, 2130, 2150, FARMALL 75C/55C/65C, JX1060V/C, JX1090U, JX1085C, JX1070C/V/U/N, JX1075C/N/V, JX1095V/C/N, JX1100U, JX1080U, JX70U, JX80U, JX55, JX55T, AVJ55, AVJ70, AVJ60, VJ80, JX60, JX80, JX95, JX75, JX65, JX85, JX90U, JX100U, QUANTUM 105F/N/V, QUANTUM 65C/95C/75C/85C, QUANTUM 85F/N/V, 95F/N/V, QUANTUM 95F/N/V, 75F/N/V, VJ70, VJ60, JX95, JX90, JX70, JX90	1966557C1, 4954935, 5122028, 5197980, 87345759, 87541562, B513160	
14382	Cuscinetto pto 110 x 70 x 20 mm / Pto Bearing 110 x 70 x 20 mm		AVJ55-AVJ60-AVJ70, JX100U-JX1070U-JX1080U, JX1090U-JX1100U, JX70U- JX80U-JX90U, VJ60-VJ70-VJ80	24905360	
LUK628105310	Kit tutto originale LUK composto da - Kit all LUK original consists of: - Meccanismo/Clutch Ref. 228 0098 10 - Disco Pto/Disc Pto 328 0186 16 - Cuscinetto/Bearing Ref. 500 0459 00 - Cuscinetto/Bearing Ref. 500 0284 00 - Cuscinetto/Bearing Ref. 410 0025 00		AVJ55, AVJ60, AVJ70, JX85, JX90, VJ60, VJ70, VJ80	9973691	    
07859	Meccanismo Frizione 11" - Luk originale	CASE	AVJ55, AVJ60, AVJ70, JX85, JX90, VJ60, VJ70, VJ80	47512400, 5162900	
07852	Disco Pto Diametro 280 mm Luk originale / Pto Disc Diameter 280 mm Original Luk		JX85, JX90, VJ80	5145715, 5154703	
LUK500045900	Cuscinetto reggispinta 90 x 50 x 21,60 mm / Thrust Bearing 90 x 50 x 21,60 mm		2140, 2120, 2130, 2150, FARMALL 75C/55C/65C, JX1060V/C, JX1090U, JX1085C, JX1070C/V/U/N, JX1075C/N/V, JX1095V/C/N, JX1100U, JX1080U, JX70U, JX80U, JX55, JX55T, AVJ55, AVJ70, AVJ60, VJ80, JX60, JX80, JX95, JX75, JX65, JX85, JX90U, JX100U, QUANTUM 105F/N/V, QUANTUM 65C/95C/75C/85C, QUANTUM 85F/N/V, 95F/N/V, QUANTUM 95F/N/V, 75F/N/V, VJ70, VJ60, JX95, JX90, JX70, JX90	1966557C1, 4954935, 5122028, 5197980, 87345759, 87541562, B513160	
LUK500028400	Cuscinetto pto 110 x 70 x 20 mm / Pto Bearing 110 x 70 x 20 mm		AVJ55-AVJ60-AVJ70, JX100U-JX1070U-JX1080U, JX1090U-JX1100U, JX70U- JX80U-JX90U, VJ60-VJ70-VJ80	24905360	
LUK410002500	Cuscinetto volano 47 x 17 x 14 mm / Bearing 47 x 17 x 14 mm		2140, 2120, 2130, 2150, FARMALL 75C/55C/65C, JX1060V/C, JX1090U, JX1085C, JX1070C/V/U/N, JX1075C/N/V, JX1095V/C/N, JX1100U, JX1080U, JX70U, JX80U, JX55, JX55T, AVJ55, AVJ70, AVJ60, VJ80, JX60, JX80, JX95, JX75, JX65, JX85, JX90U, JX100U, QUANTUM 105F/N/V, QUANTUM 65C/95C/75C/85C, QUANTUM 85F/N/V, 95F/N/V, QUANTUM 95F/N/V, 75F/N/V, VJ70, VJ60, JX95, JX90, JX70, JX90	28043280	

**KIT FRIZIONE LUK ADATTABILE RIF. 87689675 CASE**

KIT EMBRAYAGE LUK ADAPTABLE REF. 87689675 CASE

KIT CLUTCH LUK ADAPTABLE REF. 87689675 CASE

KIT KUPPLUNG LUK PASSEND ZU REF. 87689675 CASE

KIT EMBRAGUE LUK ADAPTABLE REF. 87689675 CASE

Art./Ref.	Note/Notes	Brand	Applicazione/Application	Rif. Orig./Orig. Ref.	Immagine/Image
<b>LUK628308610</b>	Kit tutto originale LUK composto da - Kit all LUK original consists of: - Meccanismo/Clutch Ref. 228 0184 10 - Disco Pto/Disc Pto 328 0332 10 - Cuscinetto/Bearing Ref. 500 0459 00 - Cuscinetto/Bearing Ref. 500 1292 10 - Cuscinetto/Bearing Ref. 410 0025 00		QUANTUM 105 F - N, QUANTUM 85 C, QUANTUM 95 F - N - V	87689675	
<b>29416</b>	Meccanismo Frizione 11" / Luk originale	<b>CASE</b>	JX 1070C MAXXIMA, JX 1075C MAXXIMA, JX 1075N - 1075V, JX 1085C, JX 1095C - 1095N - 1095V, QUANTUM 105 F - N, QUANTUM 65 C - V, QUANTUM 75 C - F - N - V, QUANTUM 85 C - F - N - V, QUANTUM 95 F - N - V	5181421, 5196813, 87732504, 87732506	
<b>29414</b>	Disco Pto Diametro 280 mm Luk originale / Pto Disc Diameter 280 mm Original Luk		JX 1070C MAXXIMA, JX 1075C MAXXIMA, JX 1075N - 1075V, JX 1085C, JX 1095C - 1095N - 1095V, QUANTUM 105 F - N, QUANTUM 65 C - V, QUANTUM 75 C - F - N - V, QUANTUM 85 C - F - N - V, QUANTUM 95 F - N - V	47134874, 5176450	
<b>LUK500045900</b>	Cuscinetto reggispinta 90 x 50 x 21,60 mm / Thrust Bearing 90 x 50 x 21,60 mm		2140,2120,2130,2150, FARMALL 75C/55C/65C, JX1060V/C, JX1090U, JX1085C, JX1070C/V/U/N, JX1075C/N/V, JX1095V/C/N, JX1100U, JX1080U, JX70U, JX80U, JX55, JX55T, AVJ55, AVJ70, AVJ60, VJ80, JX60, JX80, JX95, JX75, JX65, JX85, JX90U, JX100U, QUANTUM 105F/N/V, QUANTUM 65C/95C/75C/85C, QUANTUM 85F/N/V, 95F/N/V, QUANTUM 95F/N/V, 75F/N/V, VJ70, VJ60, JX95, JX90, JX70, JX90	1966557C1, 4954935, 5122028, 5197980, 87345759, 87541562, B513160	
<b>LUK500129210</b>	Cuscinetto pto 115 x 75 x 20 mm / Pto Bearing 115 x 75 x 20 mm		1046-1246-946, 1055-1055XL-1255-1255XL, 1056-1056XL-856-856XL, 1455-1455XL-955-955XL, 353-383-423-453-523-553-554, 433-533-633-733-833-933, 624-654-724-734-824-834, 644-744-844-844S-844XL, 743-743XL, 7455-745XL-845-845XL, 956-956SL, D323, JX1060C-JX1060V-JX1070C, JX1070N-JX1070U-JX1070V, JX1075C-JX1075N-JX1075V, JXU95	3142880R91, 5112084, 5167183	
<b>LUK410002500</b>	Cuscinetto volano 47 x 17 x 14 mm - Bearing 47 x 17 x 14 mm		2140,2120,2130,2150, FARMALL 75C/55C/65C, JX1060V/C, JX1090U, JX1085C, JX1070C/V/U/N, JX1075C/N/V, JX1095V/C/N, JX1100U, JX1080U, JX70U, JX80U, JX55, JX55T, AVJ55, AVJ70, AVJ60, VJ80, JX60, JX80, JX95, JX75, JX65, JX85, JX90U, JX100U, QUANTUM 105F/N/V, QUANTUM 65C/95C/75C/85C, QUANTUM 85F/N/V, 95F/N/V, QUANTUM 95F/N/V, 75F/N/V, VJ70, VJ60, JX95, JX90, JX70, JX90	28043280	

**KIT FRIZIONE LUK ADATTABILE RIF. 87689657 CASE**

KIT EMBRAYAGE LUK ADAPTABLE REF. 87689657 CASE

KIT CLUTCH LUK ADAPTABLE REF. 87689657 CASE

KIT KUPPLUNG LUK PASSEND ZU REF. 87689657 CASE

KIT EMBRAGUE LUK ADAPTABLE REF. 87689657 CASE

Art./Ref.	Note/Note	Brand	Applicazione/Application	Rif. Orig./Orig. Ref.	Immagine/Image
<b>LUK628103410</b>	Kit tutto originale LUK composto da - Kit all LUK original consists of: - Meccanismo/Clutch Ref. 228 0077 17 - Disco Pto/Disc Pto 328 0186 16 - Cuscinetto/Bearing Ref. 500 0459 00 - Cuscinetto/Bearing Ref. 500 0284 00 - Cuscinetto/Bearing Ref. 410 0025 00	<b>CASE</b>	JX 55 MAXXIMA, JX 60 MAXXIMA, JX 60 MAXXIMA STRADDLE, JX 65 MAXXIMA, JX 70 MAXXIMA, JX 70 MAXXIMA STRADDLE, JX 80 MAXXIMA, JX 85 MAXXIMA, JX 90 MAXXIMA, JX 90 MAXXIMA STRADDLE	87689657	
<b>07850</b>	Meccanismo Frizione 11" - Luk originale		JX 55 MAXXIMA, JX 60 MAXXIMA, JX 60 MAXXIMA STRADDLE, JX 65 MAXXIMA, JX 70 MAXXIMA, JX 70 MAXXIMA STRADDLE, JX 80 MAXXIMA, JX 85 MAXXIMA, JX 90 MAXXIMA, JX 90 MAXXIMA STRADDLE	47512408, 5154879, 5171137	
<b>07852</b>	Disco Pto Diametro 280 mm Luk originale - Pto Disc Diameter 280 mm Original Luk		JX 55 MAXXIMA, JX 60 MAXXIMA, JX 60 MAXXIMA STRADDLE, JX 65 MAXXIMA, JX 70 MAXXIMA, JX 70 MAXXIMA STRADDLE, JX 80 MAXXIMA, JX 85 MAXXIMA, JX 90 MAXXIMA, JX 90 MAXXIMA STRADDLE, JX85, JX90, VJ80	5145715, 5154703	
<b>LUK500045900</b>	Cuscinetto reggispinta 90 x 50 x 21,60 mm / Thrust Bearing 90 x 50 x 21,60 mm		2140,2120,2130,2150, FARMALL 75C/55C/65C, JX1060V/C, JX1090U, JX1085C, JX1070C/V/U/N, JX1075C/N/V, JX1095V/C/N, JX1100U, JX1080U, JX70U, JX80U, JX55, JX55T, AVJ55, AVJ70, AVJ60, VJ80, JX60, JX80, JX95, JX75, JX65, JX85, JX90U, JX100U, QUANTUM 105F/N/V, QUANTUM 65C/95C/75C/85C, QUANTUM 85F/N/V, 95F/N/V, QUANTUM 95F/N/V, 75F/N/V, VJ70, VJ60, JX95, JX90, JX70, JX90	1966557C1, 4954935, 5122028, 5197980, 87345759, 87541562, B513160	
<b>LUK500028400</b>	Cuscinetto pto 110 x 70 x 20 mm / Pto Bearing 110 x 70 x 20 mm		AVJ55-AVJ60-AVJ70, JX100U-JX1070U-JX1080U, JX1090U-JX1100U, JX70U-JX80U-JX90U, VJ60-VJ70-VJ80	24905360	
<b>LUK410002500</b>	Cuscinetto volano 47 x 17 x 14 mm - Bearing 47 x 17 x 14 mm		2140,2120,2130,2150, FARMALL 75C/55C/65C, JX 1070U - 1080U - 1090U, JX 70U MAXXIMA, JX 80U MAXXIMA, JX 90U MAXXIMA, JX1060V/C, JX1090U, JX1085C, JX1070C/V/U/N, JX1075C/N/V, JX1095V/C/N, JX1100U, JX1080U, JX70U, JX80U, JX55, JX55T, AVJ55, AVJ70, AVJ60, VJ80, JX60, JX80, JX95, JX75, JX65, JX85, JX90U, JX100U, JXU 75 - 85 - 95 - 105, QUANTUM 105F/N/V, QUANTUM 65C/95C/75C/85C, QUANTUM 85F/N/V, 95F/N/V, QUANTUM 95F/N/V, 75F/N/V, VJ70, VJ60, JX95, JX90, JX70, JX90	28043280	



**KIT FRIZIONE LUK ADATTABILE RIF. 9973687 CASE**

KIT EMBRAYAGE LUK ADAPTABLE REF. 9973687 CASE

KIT CLUTCH LUK ADAPTABLE REF. 9973687 CASE

KIT KUPPLUNG LUK PASSEND ZU REF. 9973687 CASE

KIT EMBRAGUE LUK ADAPTABLE REF. 9973687 CASE

Art./Ref.	Note/Note	Brand	Applicazione/Application	Rif. Orig./Orig. Ref.	Immagine/Image
<b>LUK631306010</b>	Kit tutto originale LUK composto da - Kit all LUK original consists of: - Meccanismo/Clutch Ref. 231 0105 10 - Disco Pto/Disc Pto 331 0220 10 - Cuscinetto/Bearing Ref. 500 0459 00 - Cuscinetto/Bearing Ref. 500 1292 10 - Cuscinetto/Bearing Ref. 410 0025 00		JX 1070U - 1080U - 1090U, JX 70U MAXXIMA, JX 80U MAXXIMA, JX 90U MAXXIMA, JXU 75 - 85 - 95 - 105	9973687	
<b>29420</b>	Meccanismo Frizione 12" - Luk Originale	<b>CASE</b>	JX 1070U - 1080U - 1090U, JX 70U MAXXIMA, JX 80U MAXXIMA, JX 90U MAXXIMA, JXU 75 - 85 - 95 - 105	5167935, 5179850, 5189875, 87716719	
<b>29421</b>	Disco Pto Diametro 310 mm Luk originale - Pto Disc Diameter 310 mm Original Luk		JX 1070U - 1080U - 1090U, JX 70U MAXXIMA, JX 80U MAXXIMA, JX 90U MAXXIMA, JXU 75 - 85 - 95 - 105	5167937	
<b>LUK500045900</b>	Cuscinetto reggispinta 90 x 50 x 21,60 mm / Thrust Bearing 90 x 50 x 21,60 mm		2140,2120,2130,2150, FARMALL 75C/55C/65C, JX1060V/C, JX1090U, JX1085C, JX1070C/V/U/N, JX 1075C/N/V, JX1095V/C/N, JX1100U, JX1080U, JX70U, JX80U, JX55, JX55T, AVJ55, AVJ70, AVJ60, VJ80, JX60, JX80, JX95, JX75, JX65, JX85, JX90U, JX100U, QUANTUM 105F/N/V, QUANTUM 65C/95C/75C/85C, QUANTUM 85F/N/V, 95F/N/V, QUANTUM 95F/N/V, 75F/N/V, VJ70, VJ60, JX95, JX90, JX70, JX90	1966557C1, 4954935, 5122028, 5197980, 87345759, 87541562, B513160	
<b>LUK500129210</b>	Cuscinetto pto 115 x 75 x 20 mm / Pto Bearing 115 x 75 x 20 mm		1046-1246-946, 1055-1055XL-1255-1255XL, 1056-1056XL-856-856XL, 1455-1455XL-955-955XL, 353-383-423-453-523-553-554, 433-533-633-733-833-933, 624-654-724-734-824-834, 644-744-844-844S-844XL, 743-743XL, 745-745XL-845-845XL, 956-956SL, D323, JX 1070U - 1080U - 1090U, JX 70U MAXXIMA, JX 80U MAXXIMA, JX 90U MAXXIMA, JX1060C-JX1060V-JX1070C, JX1070N-JX1070U-JX1070V, JX1075C-JX1075N-JX1075V, JXU 75 - 85 - 95 - 105, JXU95	3142880R91, 5112084, 5167183	
<b>LUK410002500</b>	Cuscinetto volano 47 x 17 x 14 mm - Bearing 47 x 17 x 14 mm		2140,2120,2130,2150, FARMALL 75C/55C/65C, JX 1070U - 1080U - 1090U, JX 70U MAXXIMA, JX 80U MAXXIMA, JX 90U MAXXIMA, JX1060V/C, JX1090U, JX1085C, JX1070C/V/U/N, JX1075C/N/V, JX1095V/C/N, JX1100U, JX1080U, JX70U, JX80U, JX55, JX55T, AVJ55, AVJ70, AVJ60, VJ80, JX60, JX80, JX95, JX75, JX65, JX85, JX90U, JX100U, JXU 75 - 85 - 95 - 105, QUANTUM 105F/N/V, QUANTUM 65C/95C/75C/85C, QUANTUM 85F/N/V, 95F/N/V, QUANTUM 95F/N/V, 75F/N/V, VJ70, VJ60, JX95, JX90, JX70, JX90	28043280	

**KIT FRIZIONE LUK ORIGINALE RIF. 628318112**

KIT EMBRAYAGE LUK ORIGINAL REF. 628318112

KIT CLUTCH ORIGINAL LUK REF. 628318112

KIT KUPPLUNG LUK REF. 628318112

KIT EMBRAGUE LUK ORIGINAL REF. 628318112

Art./Ref.	Note/Note	Brand	Applicazione/Application	Rif. Orig./Orig. Ref.	Immagine/Image
<b>LUK628318112</b>	Kit tutto originale LUK composto da - Kit all LUK original consists of: - Meccanismo/Clutch Ref. 128 0302 10 - Disco Pto/Disc Pto 328 0332 11 - Cuscinetto/Bearing Ref. 500 1292 10 - Cuscinetto/Bearing Ref. 410 0133 10		JX 1060C MAXXIMA, JX 1060V MAXXIMA, JX 1070C MAXXIMA, JX 1070N - 1070V, JX 1075C MAXXIMA, JX 1075N - 1075V, JX 1085C - 1095C, JX 1095N - 1095V, QUANTUM 105 F-N-V, QUANTUM 65 C-V, QUANTUM 75 F-N-V, QUANTUM 85 C-F-N-V, QUANTUM 95 F-N-V	47134884, 5186548, 5196770, 87732490	
<b>29865</b>	Meccanismo Frizione 11" - Luk Originale	<b>CASE</b>	JX 1060C MAXXIMA, JX 1060V MAXXIMA, JX 1070C MAXXIMA, JX 1070N - 1070V, JX 1075C MAXXIMA, JX 1075N - 1075V, JX 1085C - 1095C, JX 1095N - 1095V, QUANTUM 105 F-N-V, QUANTUM 65 C-V, QUANTUM 75 F-N-V, QUANTUM 85 C-F-N-V, QUANTUM 95 F-N-V	47134884, 5186548, 5196770, 87732490	
<b>29414</b>	Disco Pto Diametro 280 mm Luk originale - Pto Disc Diameter 280 mm Original Luk		JX 1060C MAXXIMA, JX 1060V MAXXIMA, JX 1070C MAXXIMA, JX 1070N - 1070V, JX 1075C MAXXIMA, JX 1075N - 1075V, JX 1085C, JX 1095C - 1095N - 1095V, QUANTUM 105 F - N, QUANTUM 65 C - V, QUANTUM 75 C - F - N - V, QUANTUM 85 C - F - N - V, QUANTUM 95 F - N - V	47134874, 5176450	
<b>LUK500129210</b>	Cuscinetto pto 115 x 75 x 20 mm / Pto Bearing 115 x 75 x 20 mm		1046-1246-946, 1055-1055XL-1255-1255XL, 1056-1056XL-856-856XL, 1455-1455XL-955- 955XL, 353-383-423-453-523-553-554, 433-533- 633-733-833-933, 624-654-724-734-824-834, 644-744-844-844S-844XL, 743-743XL, 745S-745XL- 845-845XL, 956-956SL, D323, JX 1070U - 1080U - 1090U, JX 70U MAXXIMA, JX 80U MAXXIMA, JX 90U MAXXIMA, JX1060C-JX1060V-JX1070C, JX1070N- JX1070U-JX1070V, JX1075C-JX1075N-JX1075V, JXU 75 - 85 - 95 - 105, JXU95	3142880R91, 5112084, 5167183	
<b>LUK410013310</b>	Cuscinetto volano 40 x 17 x 12 mm - Bearing 40 x 17 x 12 mm		JX 1060C MAXXIMA, JX 1060V MAXXIMA, JX 1070C MAXXIMA, JX 1070N - 1070V, JX 1075C MAXXIMA, JX 1075N - 1075V, JX 1085C - 1095C, JX 1095N - 1095V, QUANTUM 105 F-N-V, QUANTUM 65 C-V, QUANTUM 75 F-N-V, QUANTUM 85 C-F-N-V, QUANTUM 95 F-N-V	87729147	

**KIT FRIZIONE LUK ORIGINALE RIF. 631200110**

KIT EMBRAYAGE LUK ORIGINAL REF. 631200110

KIT CLUTCH ORIGINAL LUK REF. 631200110

KIT KUPPLUNG LUK REF. 631200110

KIT EMBRAGUE LUK ORIGINAL REF. 631200110

Art./Ref.	Note/Note	Brand	Applicazione/Application	Rif. Orig./Orig. Ref.	Immagine/Image
<b>LUK631200110</b>	<p>Kit tutto originale LUK composto da - Kit all LUK original consists of:</p> <ul style="list-style-type: none"> <li>- Meccanismo/Clutch Ref. 231 0089 10</li> <li>- Disco Pto/Disc Pto 331 0220 10</li> <li>- Cuscinetto/Bearing Ref. 500 0459 00</li> <li>- Cuscinetto/Bearing Ref. 500 1292 10</li> <li>- Cuscinetto/Bearing Ref. 410 0025 00</li> </ul>		JX 70U MAXXIMA	87689674	    
<b>29422</b>	Meccanismo Frizione 12" - Luk Originale	<b>CASE</b>	JX 70U MAXXIMA	5167933	
<b>29421</b>	Disco Pto Diametro 310 mm Luk originale - Pto Disc Diameter 310 mm Original Luk		JX 1070U - 1080U - 1090U, JX 70U MAXXIMA, JX 80U MAXXIMA, JX 90U MAXXIMA, JXU 75 - 85 - 95 - 105	5167937	
<b>LUK500045900</b>	Cuscinetto reggispinta 90 x 50 x 21,60 mm / Thrust Bearing 90 x 50 x 21,60 mm		2140,2120,2130,2150, FARMALL 75C/55C/65C, JX1060V/C, JX1090U, JX1085C, JX1070C/V/U/N, JX1075C/N/V, JX1095V/C/N, JX1100U, JX1080U, JX70U, JX80U, JX55, JX55T, AVJ55, AVJ70, AVJ60, VJ80, JX60, JX80, JX95, JX75, JX65, JX85, JX90U, JX100U, QUANTUM 105F/N/V, QUANTUM 65C/95C/75C/85C, QUANTUM 85F/N/V, 95F/N/V, QUANTUM 95F/N/V, 75F/N/V, VJ70, VJ60, JX95, JX90, JX70, JX90	1966557C1, 4954935, 5122028, 5197980, 87345759, 87541562, B513160	
<b>LUK500129210</b>	Cuscinetto pto 115 x 75 x 20 mm / Pto Bearing 115 x 75 x 20 mm		1046-1246-946, 1055-1055XL-1255-1255XL, 1056-1056XL-856-856XL, 1455-1455XL-955-955XL, 353-383-423-453-523-553-554, 433-533-633-733-833-933, 624-654-724-734-824-834, 644-744-844-844S-844XL, 743-743XL, 745S-745XL-845-845XL, 956-956SL, D323, JX 1070U - 1080U - 1090U, JX 70U MAXXIMA, JX 80U MAXXIMA, JX 90U MAXXIMA, JX1060C- JX1060V- JX1070C, JX1070N- JX1070U- JX1070V, JX1075C- JX1075N- JX1075V, JXU 75 - 85 - 95 - 105, JXU95	3142880R91, 5112084, 5167183	
<b>LUK410002500</b>	Cuscinetto volano 47 x 17 x 14 mm - Bearing 47 x 17 x 14 mm		2140,2120,2130,2150, FARMALL 75C/55C/65C, JX 1070U - 1080U - 1090U, JX 70U MAXXIMA, JX 80U MAXXIMA, JX 90U MAXXIMA, JX1060V/C, JX1090U, JX1085C, JX1070C/V/U/N, JX1075C/N/V, JX1095V/C/N, JX1100U, JX1080U, JX70U, JX80U, JX55, JX55T, AVJ55, AVJ70, AVJ60, VJ80, JX60, JX80, JX95, JX75, JX65, JX85, JX90U, JX100U, JXU 75 - 85 - 95 - 105, QUANTUM 105F/N/V, QUANTUM 65C/95C/75C/85C, QUANTUM 85F/N/V, 95F/N/V, QUANTUM 95F/N/V, 75F/N/V, VJ70, VJ60, JX95, JX90, JX70, JX90	28043280	



**KIT FRIZIONE LUK ORIGINALE RIF. 131024910+331021910+500124010**

KIT EMBRAYAGE LUK ORIGINAL REF. 131024910+331021910+500124010

KIT CLUTCH ORIGINAL LUK REF. 131024910+331021910+500124010

KIT KUPPLUNG LUK REF. 131024910+331021910+500124010

KIT EMBRAGUE LUK ORIGINAL REF. 131024910+331021910+500124010

Art./Ref.	Note/Note	Brand	Applicazione/Application	Rif. Orig./Orig. Ref.	Immagine/Image
<b>29418</b>	Meccanismo Frizione 12" - Luk originale	<b>CASE</b>	JX100U-JX1070U-JX1080U-JX1090U, JX1100U-JX70U-JX80U-JX90U	5189823	
<b>29419</b>	Disco avanzamento 310 mm a 6 pale Luk originale - Clutch Disc Diameter 310 mm 6 pairs of pads Original Luk		JX100U-JX1070U-JX1080U-JX1090U, JX1100U-JX70U-JX80U-JX90U	5167936, 5189825	
<b>LUK500124010</b>	Cuscinetto reggispinta completo 110 x 65 x 210 mm / Bearing + carrier assy 110 x 65 x 210 mm		JX100U-JX1070U-JX1080U-JX1090U, JX1100U-JX70U-JX80U-JX90U	5166287	



**KIT FRIZIONE LUK ORIGINALE RIF. MECCANISMO 5177618**

KIT EMBRAYAGE LUK ORIGINAL REF. 5177618

KIT CLUTCH ORIGINAL LUK REF. 5177618

KIT KUPPLUNG LUK REF. 5177618

KIT EMBRAGUE LUK ORIGINAL REF. 5177618

Art./Ref.	Note/Note	Brand	Applicazione/Application	Rif. Orig./Orig. Ref.	Immagine/Image
<b>07877</b>	Meccanismo Frizione 13" - Luk originale	<b>CASE</b>	MXM 120 MAXXUM, MXM 130 MAXXUM, MXM 140 MAXXUM	5154418, 5177618	
<b>07878</b>	Disco avanzamento 330 mm a 5 pale Luk originale - Clutch Disc Diameter 330 mm 5 pairs of pads Original Luk		MXM 120 MAXXUM, MXM 130 MAXXUM, MXM 140 MAXXUM	5165650	
<b>LUK500085130</b>	Cuscinetto reggispinta completo 115 x 65 x 30 mm / Bearing + carrier assy 115 x 65 x 30 mm		MXM 120 MAXXUM, MXM 130 MAXXUM, MXM 140 MAXXUM	5149611, 9967339	



**KIT FRIZIONE LUK ORIGINALE RIF. MECCANISMO 5092803**

KIT EMBRAYAGE LUK ORIGINAL REF. 5092803

KIT CLUTCH ORIGINAL LUK REF. 5092803

KIT KUPPLUNG LUK REF. 5092803

KIT EMBRAGUE LUK ORIGINAL REF. 5092803

Art./Ref.	Note/Note	Brand	Applicazione/Application	Rif. Orig./Orig. Ref.	Immagine/Image
<b>VALE0805980</b>	Meccanismo Frizione 12" - Valeo originale	<b>CASE</b>	JX 90 MAXXIMA, JX 95 MAXXIMA, JX 95 MAXXIMA STRADDLE	5092803, 84177332	
<b>LUK331032310</b>	Disco Pto Diametro 310 mm Luk originale - Pto Disc Diameter 310 mm Original Luk		JX 90 MAXXIMA, JX 95 MAXXIMA, JX 95 MAXXIMA STRADDLE	5089337, 5092802	
<b>LUK500045900</b>	Cuscinetto reggispinta 90 x 50 x 21,60 mm / Thrust Bearing 90 x 50 x 21,60 mm		2140,2120,2130,2150, FARMALL 75C/55C/65C, JX1060V/C, JX1090U, JX1085C, JX1070C/V/U/N, JX1075C/N/V, JX1095V/C/N, JX1100U, JX1080U, JX70U, JX80U, JX55, JX55T, AVJ55, AVJ70, AVJ60, VJ80, JX60, JX80, JX95, JX75, JX65, JX85, JX90U, JX100U, QUANTUM 105F/N/V, QUANTUM 65C/95C/75C/85C, QUANTUM 85F/N/V, 95F/N/V, QUANTUM 95F/N/V, 75F/N/V, VJ70, VJ60, JX95, JX90, JX70, JX90	1906557C1, 4954935, 5122028, 5197980, 87345759, 87541562, B513160	

Art./Ref.	Note/Note	Brand	Applicazione/Application	Rif. Orig./Orig. Ref.	Immagine/Image	
LUK500028400	Cuscinetto pto 110 x 70 x 20 mm / Pto Bearing 110 x 70 x 20 mm		AVJ55-AVJ60-AVJ70, JX100U-JX1070U-JX1080U, JX1090U-JX1100U, JX70U-JX80U-JX90U, VJ60-VJ70-VJ80	24905360		
LUK410002500	Cuscinetto volano 47 x 17 x 14 mm - Bearing 47 x 17 x 14 mm	CASE	2140,2120,2130,2150, FARMALL 75C/55C/65C, JX 1070U - 1080U - 1090U, JX 70U MAXXIMA, JX 80U MAXXIMA, JX 90U MAXXIMA, JX1060V/C, JX1090U, JX1085C, JX1070C/V/U/N, JX1075C/N/V, JX1095V/C/N, JX1100U, JX1080U, JX70U, JX80U, JX55, JX55T, AVJ55, AVJ70, AVJ60, VJ80, JX60, JX80, JX95, JX75, JX65, JX85, JX90U, JX100U, JXU 75 - 85 - 95 - 105, QUANTUM 105F/N/V, QUANTUM 65C/95C/75C/85C, QUANTUM 85F/N/V, 95F/N/V, QUANTUM 95F/N/V, 75F/N/V, VJ70, VJ60, JX95, JX90, JX70, JX90		28043280	

**KIT FRIZIONE ADATTABILE RIF. 9973691 FIAT**

KIT EMBRAYAGE ADAPTABLE REF. 9973691 FIAT

KIT CLUTCH ADAPTABLE REF. 9973691 FIAT

KIT KUPPLUNG PASSEND ZU REF. 9973691 FIAT

KIT EMBRAGUE ADAPTABLE REF. 9973691 FIAT

Art./Ref.	Note/Note	Brand	Applicazione/Application	Rif. Orig./Orig. Ref.	Immagine/Image	
57940	Kit composto da - Kit consists of: - Meccanismo/Clutch Ref. 5162900 With box Original CNH - Disco Pto/Disc Pto Ref. 5154703 Not Original - Cuscinetto/Bearing Ref. 5122028 Not Original - Cuscinetto/Bearing Ref. 24905360 Not Original		446-466-540S, 55.56, 55.56 DT, 55.66S, 55.66S DT, 570-580-670-680-780, 60.56 DT, 60.66S, 60.66S DT, 60.93, 60.93 DT, 60.94, 60.94 DT, 62.86F, 62.86F DT, 640 SECONDA SERIE, 65.56, 65.56 DT, 65.66S, 65.66S DT, 65.93, 65.93 DT, 65.94, 65.94 DT, 70.56, 70.56 DT, 70.66S, 70.66S DT, 72.86 LP, 72.86 LP DT, 72.86F, 72.86F DT, 72.93, 72.93 DT, 72.94, 72.94 DT, 80.66S, 80.66S DT, 82.86 LP, 82.86F, 82.86F DT, 82.93, 82.93 DT, 82.94, 82.94 DT, 88.93, 88.93 DT, 88.94, 88.94 DT	9973691		
NH5162900	Meccanismo Frizione 11" - Fiat originale	FIAT	446-466-540S, 55.56, 55.56 DT, 55.66S, 55.66S DT, 570-580-670-680-780, 60.56 DT, 60.66S, 60.66S DT, 60.93, 60.93 DT, 60.94, 60.94 DT, 62.86F, 62.86F DT, 640 SECONDA SERIE, 65.56, 65.56 DT, 65.66S, 65.66S DT, 65.93, 65.93 DT, 65.94, 65.94 DT, 70.56, 70.56 DT, 70.66S, 70.66S DT, 72.86 LP, 72.86 LP DT, 72.86F, 72.86F DT, 72.93, 72.93 DT, 72.94, 72.94 DT, 80.66S, 80.66S DT, 82.86 LP, 82.86F, 82.86F DT, 82.93, 82.93 DT, 82.94, 82.94 DT, 88.93, 88.93 DT, 88.94, 88.94 DT	47512400, 5162900		
26988	Disco Pto Diametro 280 mm - Pto Disc Diameter 280 mm		446 - 446DT, 466 - 466DT, 480 - 480DT, 500 - 500DT, 52.86, 540 - 540DT - 540S, 55-56LM, 55.46, 55.56, 55.56F, 55.66, 55.66LP, 55.88, 55.90, 550, 566, 570, 580, 60-66F, 60-66LP, 60.46, 60.56, 60.66, 60.66S, 60.76, 60.76F, 60.88, 60.90, 60.90LP/F, 60.93, 60.94, 600, 60IIF-70IIF-90IIF, 62.86F, 640, 65-66S, 65-66V, 65.46, 65.56, 65.56F, 65.56L, 65.66, 65.66F, 65.88, 65.90, 65.90L, 65.93, 65.94, 666, 666DT, 670, 670F, 680, 70-66, 70-66F, 70-66LP, 70.56, 70.66, 70.66LP/F, 70.66S, 70.66V, 70.76, 70.76V, 70.88, 70.90, 70.90LP/F, 72.86, 72.86LP, 72.93, 72.94, 780, 80.66, 80.66F, 80.66S, 80.76, 80.88, 80.90, 80/FL, 82.86, 82.86F, 82.86LP, 82.93, 82.93DT, 82.94, 82.94DT, 85.90, 88.93, 88.93DT, 88.94, 88.94DT, 90/LP		5145715, 5154703	
12841	Cuscinetto reggispira 90 x 50 x 21,60 mm / Thrust Bearing 90 x 50 x 21,60 mm		35-66,35-66DT,45-66,45-66DT, 446,446DT,466,466DT,480,480DT, 50-66,50-66DT,50-66S,55-66, 50-86,50-86V,50-86VDT,60-86F, 500,500DT,540,540DT,540S,550, 55-46,55-46DT,65-46,65-46DT, 55-66DTLP,60-66,60-66DT,65-66, 55-76F,55-76DT,55-76V,55-76VDT, 55-90,55-90DT,60-90,60-90DT, 566,570,580,600,640,666,670, 60-76F,60-76FDT,70-76DT, 60-86FDT,62-86F,70-86V,72-86F, 65-66DT,70-66,70-66DT,70-66F, 65-90,65-90DT,70-90,70-90DT, 680,766,780,880,880-5,980, 70-66LP,70-66V,80-66,80-66DT,70-76LP,70-76V,80-76DT,80-76F, 70-86VDT,72-86LP,82-86DT, 72-93,72-93DT,82-93,82-93DT, 72-94,72-94DT,82-94,82-94DT, 80-88,80-88DT,100-90,100-90DT, 80-90,80-90DT,85-90,85-90DT, 82-86F,82-86LP,70-88,70-88DT, 88-93,88-93DT,65-94,65-94DT, 88-94,88-94DT,A100SDT,A110, 90-90,90-90DT,65-93,65-93DT, 980DT,L60,L65,L75,L85,L95, A110SDT,A90SDT		4954935, 5122028, 5157318, 5197980, 82824591, 82824592, 87289219, 87345759, 87541561, 87541562, 9976506	

Art./Ref.	Note/Note	Brand	Applicazione/Application	Rif. Orig./Orig. Ref.	Immagine/Image
<b>14882</b>	Cuscinetto pto 110 x 70 x 20 mm / Pto Bearing 110 x 70 x 20 mm	<b>FIAT</b>	115.90-115.90DT, 130.90-130.90DT, 140.90-140.90DT, 160.90-160.90DT, 180.90-180.90DT, 446-446DT, 466-466DT, 480-480DT, 500-500DT, 540-540DT-540S, 55.46, 55.48, 55.55, 55.56, 55.56LM, 55.60, 55.65, 55.66, 55.66 LP, 55.66LP, 55.70, 55.88, 55.90, 550, 566, 570, 570F, 570V, 580, 60.46, 60.56, 60.66, 60.66F, 60.66LP, 60.66S, 60.76, 60.76F, 60.88, 60.90, 60.90/LPF, 60.93, 60.94, 600, 6011F, 7011F, 8011F, 62.86, 62.86F, 640, 65.46, 65.56, 65.56L, 65.66, 65.66F, 65.66S, 65.66V, 65.88, 65.90, 65.90L, 65.93, 65.94, 666, 666DT, 670, 670F, 680, 70.56, 70.66, 70.66LP, 70.66LP/F, 70.66S, 70.66V, 70.76, 70.76F, 70.76LP, 70.76V, 70.88, 70.90, 70.90/LPF, 72.86, 72.86LP, 72.93, 72.94, 740, 766, 780, 80.46, 80.56, 80.60, 80.66, 80.66F, 80.66S, 80.70, 80.75, 80.76, 80.85, 80.88, 80.90, 80/FL, 82.86, 82.86LP, 82.93, 82.93DT, 82.94, 82.94DT, 85.90, 88.93, 88.93DT, 88.94, 88.94DT, 880, 90/LP	24905360	
<b>84025</b>	Kit composto da - Kit consists of: - Meccanismo/Clutch Ref. 5162900 With box Original LUK - Disco Pto/Disc Pto Ref. 5154703 Not Original - Cuscinetto/Bearing Ref. 5122028 Not Original - Cuscinetto/Bearing Ref. 24905360 Not Original		446-466-540S, 55.56, 55.56 DT, 55.66S, 55.66S DT, 570-580-670-680-780, 60.56 DT, 60.66S, 60.66S DT, 60.93, 60.93 DT, 60.94, 60.94 DT, 62.86F, 62.86F DT, 640 SECONDA SERIE, 65.56, 65.56 DT, 65.66S, 65.66S DT, 65.93, 65.93 DT, 65.94, 65.94 DT, 70.56, 70.56 DT, 70.66S, 70.66S DT, 72.86 LP, 72.86 LP DT, 72.86F, 72.86F DT, 72.93, 72.93 DT, 72.94, 72.94 DT, 80.66S, 80.66S DT, 82.86 LP, 82.86F, 82.86F DT, 82.93, 82.93 DT, 82.94, 82.94 DT, 88.93, 88.93 DT, 88.94, 88.94 DT	9973691	
<b>07859</b>	Meccanismo Frizione 11" - Luk originale		446-466-540S, 55.56, 55.56 DT, 55.66S, 55.66S DT, 570-580-670-680-780, 60.56 DT, 60.66S, 60.66S DT, 60.93, 60.93 DT, 60.94, 60.94 DT, 62.86F, 62.86F DT, 640 SECONDA SERIE, 65.56, 65.56 DT, 65.66S, 65.66S DT, 65.93, 65.93 DT, 65.94, 65.94 DT, 70.56, 70.56 DT, 70.66S, 70.66S DT, 72.86 LP, 72.86 LP DT, 72.86F, 72.86F DT, 72.93, 72.93 DT, 72.94, 72.94 DT, 80.66S, 80.66S DT, 82.86 LP, 82.86F, 82.86F DT, 82.93, 82.93 DT, 82.94, 82.94 DT, 88.93, 88.93 DT, 88.94, 88.94 DT	47512400, 5162900	
<b>26988</b>	Disco Pto Diametro 280 mm - Pto Disc Diameter 280 mm	<b>FIAT</b>	446 - 446DT, 466 - 466DT, 480 - 480DT, 500 - 500DT, 52.86, 540 - 540DT - 540S, 55-56LM, 55.46, 55.56, 55.56F, 55.66, 55.66LP, 55.88, 55.90, 550, 566, 570, 580, 60-66F, 60-66LP, 60.46, 60.56, 60.66, 60.66S, 60.76, 60.76F, 60.88, 60.90, 60.90LP/F, 60.93, 60.94, 600, 6011F-7011F-8011F, 62.86F, 640, 65-66S, 65-66V, 65.46, 65.56, 65.56F, 65.56L, 65.66, 65.66F, 65.88, 65.90, 65.90L, 65.93, 65.94, 666, 666DT, 670, 670F, 680, 70-66, 70-66F, 70-66LP, 70.56, 70.66, 70.66LP/F, 70.66S, 70.66V, 70.76, 70.76V, 70.88, 70.90, 70.90LP/F, 72.86, 72.86LP, 72.93, 72.94, 780, 80.66, 80.66F, 80.66S, 80.76, 80.88, 80.90, 80/FL, 82.86, 82.86F, 82.86LP, 82.93, 82.93DT, 82.94, 82.94DT, 85.90, 88.93, 88.93DT, 88.94, 88.94DT, 90/LP	5145715, 5154703	
<b>12841</b>	Cuscinetto reggispinta 90 x 50 x 21,60 mm / Thrust Bearing 90 x 50 x 21,60 mm		35-66,35-66DT,45-66,45-66DT, 446,446DT,466,466DT,480,480DT, 50-66,50-66DT,50-66S,55-66, 50-86,50-86V,50-86VDT,60-86F, 500,500DT,540,540DT,540S,550, 55-46,55-46DT,65-46,65-46DT, 55-66DTLP,60-66,60-66DT,65-66, 55-76F,55-76DT,55-76V,55-76VDT, 55-90,55-90DT,60-90,60-90DT, 566,570,580,600,640,666,670, 60-76F,60-76FDT,70-76DT, 60-86FDT,62-86F,70-86V,72-86F, 65-66DT,70-66,70-66DT,70-66F, 65-90,65-90DT,70-90,70-90DT, 680,766,780,880,880-5,980, 70-66LP,70-66V,80-66,80-66DT, 70-76LP,70-76V,80-76DT,80-76F, 70-86VDT,72-86LP,82-86DT, 72-93,72-93DT,82-93,82-93DT, 72-94,72-94DT,82-94,82-94DT, 80-88,80-88DT,100-90,100-90DT, 80-90,80-90DT,85-90,85-90DT, 82-86F,82-86LP,70-88,70-88DT, 88-93,88-93DT,65-94,65-94DT, 88-94,88-94DT,A100SDT,A110, 90-90,90-90DT,65-93,65-93DT, 980DT,L60,L65,L75,L85,L95, A110SDT,A90SDT	4954935, 5122028, 5157318, 5197980, 82824591, 82824592, 87289219, 87345759, 87541561, 87541562, 9976506	
<b>14882</b>	Cuscinetto pto 110 x 70 x 20 mm / Pto Bearing 110 x 70 x 20 mm		115.90-115.90DT, 130.90-130.90DT, 140.90-140.90DT, 160.90-160.90DT, 180.90-180.90DT, 446-446DT, 466-466DT, 480-480DT, 500-500DT, 540-540DT-540S, 55.46, 55.48, 55.55, 55.56, 55.56LM, 55.60, 55.65, 55.66, 55.66 LP, 55.66LP, 55.70, 55.88, 55.90, 550, 566, 570, 570F, 570V, 580, 60.46, 60.56, 60.66, 60.66F, 60.66LP, 60.66S, 60.76, 60.76F, 60.88, 60.90, 60.90/LPF, 60.93, 60.94, 600, 6011F, 7011F, 8011F, 62.86, 62.86F, 640, 65.46, 65.56, 65.56L, 65.66, 65.66F, 65.66S, 65.66V, 65.88, 65.90, 65.90L, 65.93, 65.94, 666, 666DT, 670, 670F, 680, 70.56, 70.66, 70.66LP, 70.66LP/F, 70.66S, 70.66V, 70.76, 70.76F, 70.76LP, 70.76V, 70.88, 70.90, 70.90/LPF, 72.86, 72.86LP, 72.93, 72.94, 740, 766, 780, 80.46, 80.56, 80.60, 80.66, 80.66F, 80.66S, 80.70, 80.75, 80.76, 80.85, 80.88, 80.90, 80/FL, 82.86, 82.86LP, 82.93, 82.93DT, 82.94, 82.94DT, 85.90, 88.93, 88.93DT, 88.94, 88.94DT, 880, 90/LP	24905360	

Art./Ref.	Note/Note	Brand	Applicazione/Application	Rif. Orig./Orig. Ref.	Immagine/Image
<b>LUK628105310</b>	<p>Kit tutto originale LUK composto da - Kit all LUK original consists of:</p> <ul style="list-style-type: none"> <li>- Meccanismo Clutch Ref. 228 0098 10</li> <li>- Disco Pto/Disc Pto 328 0186 16</li> <li>- Cuscinetto/Bearing Ref. 500 0459 00</li> <li>- Cuscinetto/Bearing Ref. 500 0284 00</li> <li>- Cuscinetto/Bearing Ref. 410 0025 00</li> </ul>		446-466-540S, 55.56, 55.56 DT, 55.66S, 55.66S DT, 570-580-670-680-780, 60.56 DT, 60.66S, 60.66S DT, 60.93, 60.93 DT, 60.94, 60.94 DT, 62.86F, 62.86F DT, 640 SECONDA SERIE, 65.56, 65.56 DT, 65.66S, 65.66S DT, 65.93, 65.93 DT, 65.94, 65.94 DT, 70.56, 70.56 DT, 70.66S, 70.66S DT, 72.86 LP, 72.86 LP DT, 72.86F, 72.86F DT, 72.93, 72.93 DT, 72.94, 72.94 DT, 80.66S, 80.66S DT, 82.86 LP, 82.86F, 82.86F DT, 82.93, 82.93 DT, 82.94, 82.94 DT, 88.93, 88.93 DT, 88.94, 88.94 DT	9973691	
<b>07859</b>	Meccanismo Frizione 11" - Luk originale		446-466-540S, 55.56, 55.56 DT, 55.66S, 55.66S DT, 570-580-670-680-780, 60.56 DT, 60.66S, 60.66S DT, 60.93, 60.93 DT, 60.94, 60.94 DT, 62.86F, 62.86F DT, 640 SECONDA SERIE, 65.56, 65.56 DT, 65.66S, 65.66S DT, 65.93, 65.93 DT, 65.94, 65.94 DT, 70.56, 70.56 DT, 70.66S, 70.66S DT, 72.86 LP, 72.86 LP DT, 72.86F, 72.86F DT, 72.93, 72.93 DT, 72.94, 72.94 DT, 80.66S, 80.66S DT, 82.86 LP, 82.86F, 82.86F DT, 82.93, 82.93 DT, 82.94, 82.94 DT, 88.93, 88.93 DT, 88.94, 88.94 DT	47512400, 5162900	
<b>07852</b>	Disco Pto Diametro 280 mm Luk originale - Pto Disc Diameter 280 mm Original Luk	<b>FIAT</b>	440,446,450UTB,480,480/8,500S, 55.46,55.56,55.66,55.66LP,, 550,870,570V,570F,580,600,640, 60.66,60.88,60.90,65.88,65.90, 60.66S,60.88,62.86F,65.66, 65.46,65.66,65.56L,70.56,70.66, 65.90,65.93, 65.94,70.56,70.66, 670,670F,680,780, 70.66LP/F,70.90,80.66,80.66F, 70.76,72.86,80.76,82.86,80.90, 70.90,85.90,82.93,82.94,88.93, 88.94,55.66,55.88,55.90,60.46	5145715, 5154703	
<b>LUK500045900</b>	Cuscinetto reggispinta 90 x 50 x 21,60 mm / Thrust Bearing 90 x 50 x 21,60 mm		446,446DT,466,466DT,480,480DT, 50-66,50-66DT,50-66S,55-66, 50-86,50-86V,50-86VDT,60-86F, 500,500DT,540,540DT,540S,550, 55-46,55-46DT,65-46,65-46DT, 55-66DTLP,60-66,60-66DT,65-66, 55-76F,55-76DT,55-76V,55-76VDT, 55-90,55-90DT,60-90,60-90DT, 566,570,580,600,640,666,670, 60-76F,60-76FDT,70-76DT, 60-86F,62-86F,70-86V,72-86F, 65-66DT,70-66,70-66DT,70-66F, 65-90,65-90DT,70-90,70-90DT, 680,766,780,880,880-5,980, 70-66LP,70-66V,80-66,80-66DT, 70-76LP,70-76V,80-76DT,80-76F, 70-86VDT,72-86LP,82-86DT, 72-93,72-93DT,82-93,82-93DT, 72-94,72-94DT,82-94,82-94DT, 80-88,80-88DT,100-90,100-90DT, 80-90,80-90DT,85-90,85-90DT, 82-86F,82-86LP,70-88,70-88DT, 88-93,88-93DT,65-94,65-94DT, 88-94,88-94DT,A100SDT,A110, 90-90,90-90DT,65-93,65-93DT, 980DT,L60,L65,L75,L85,L95, A110SDT,A90SDT	4954935, 5122028, 5157318, 5197980, 82824591, 82824592, 87289219, 87345759, 87541561, 87541562, 9976506	
<b>LUK500028400</b>	Cuscinetto pto 110 x 70 x 20 mm / Pto Bearing 110 x 70 x 20 mm		115.90-115.90DT, 130.90-130.90DT, 140.90-140.90DT, 160.90-160.90DT, 180.90-180.90DT, 446-446DT, 466-466DT, 480-480DT, 500-500DT, 540-540DT-540S, 55.46, 55.48, 55.55, 55.56, 55.56LM, 55.60, 55.65, 55.66, 55.66 LP, 55.66LP, 55.70, 55.88, 55.90, 550, 566, 570, 570F, 570V, 580, 60.46, 60.56, 60.66, 60.66F, 60.66LP, 60.66S, 60.76, 60.76F, 60.88, 60.90, 60.90/LPF, 60.93, 60.94, 600, 600IF, 700IF, 800IF, 62.86, 62.86F, 640, 65.46, 65.56, 65.56L, 65.66, 65.66F, 65.66S, 65.66V, 65.88, 65.90, 65.90L, 65.93, 65.94, 666, 666DT, 670, 670F, 680, 70.56, 70.66, 70.66LP, 70.66LP/F, 70.66S, 70.66V, 70.76, 70.76F, 70.76LP, 70.76V, 70.88, 70.90, 70.90/LPF, 72.86, 72.86LP, 72.93, 72.94, 740, 766, 780, 80.46, 80.56, 80.60, 80.66, 80.66F, 80.66S, 80.70, 80.75, 80.76, 80.85, 80.88, 80.90, 80/F, 82.86, 82.86LP, 82.93, 82.93DT, 82.94, 82.94DT, 85.90, 88.93, 88.93DT, 88.94, 88.94DT, 880, 90/LP	24905360	
<b>LUK410002500</b>	Cuscinetto volano 47 x 17 x 14 mm - Bearing 47 x 17 x 14 mm		35-66,35-66DT,45-66,45-66DT, 446,446DT,466,466DT,480,480DT, 50-66,50-66DT,50-66S,55-66, 50-86,50-86V,50-86VDT,60-86F, 500,500DT,540,540DT,540S,550, 55-46,55-46DT,65-46,65-46DT, 55-66DTLP,60-66,60-66DT,65-66, 55-76F,55-76DT,55-76V,55-76VDT, 55-90,55-90DT,60-90,60-90DT, 566,570,580,600,640,666,670, 60-76F,60-76FDT,70-76DT, 60-86FDT,62-86F,70-86V,72-86F, 65-66DT,70-66,70-66DT,70-66F, 65-90,65-90DT,70-90,70-90DT, 680,766,780,880,880-5,980, 70-66LP,70-66V,80-66,80-66DT, 70-76LP,70-76V,80-76DT,80-76F, 70-86VDT,72-86LP,82-86DT, 72-93,72-93DT,82-93,82-93DT, 72-94,72-94DT,82-94,82-94DT, 80-88,80-88DT,100-90,100-90DT, 80-90,80-90DT,85-90,85-90DT, 82-86F,82-86LP,70-88,70-88DT, 88-93,88-93DT,65-94,65-94DT, 88-94,88-94DT,A100SDT,A110, 90-90,90-90DT,65-93,65-93DT, 980DT,L60,L65,L75,L85,L95, A110SDT,A90SDT	28043280	













**KIT FRIZIONE ADATTABILE RIF. 9973696 FIAT**

KIT EMBRAYAGE ADAPTABLE REF. 9973696 FIAT

KIT CLUTCH ADAPTABLE REF. 9973696 FIAT

KIT KUPPLUNG PASSEND ZU REF. 9973696 FIAT

KIT EMBRAGUE ADAPTABLE REF. 9973696 FIAT







Art./Ref.	Note/Note	Brand	Applicazione/Application	Rif. Orig./Orig. Ref.	Immagine/Image
<b>57941</b>	Kit composto da - Kit consists of: - Meccanismo/Clutch Ref. 5163936 With box Original CNH - Disco Pto/Disc Pto Ref. 5154514 Not Original - Cuscinetto/Bearing Ref. 5122028 Not Original - Cuscinetto/Bearing Ref. 5112084 Not Original	FIAT	100.90, 100.90 DT, 110.90, 110.90 DT, 880.5, 90.90, 90.90 DT, 980, 980DT, A100SDT, A110, A110SDT, A90SDT, SOM880/4	9973696	   
<b>NH5163936</b>	Meccanismo Frizione 12" - Fiat originale		100.90, 100.90 DT, 110.90, 110.90 DT, 880.5, 90.90, 90.90 DT, 980, 980DT, A100SDT, A110, A110SDT, A90SDT, SOM880/4	5163936	
<b>26990</b>	Disco Pto Diametro 310 mm - Pto Disc Diameter 310 mm		100.90, 100.90DT, 110.90, 880, 880-5,980,980DT, 880/5, 90.90, 90.90DT, 980, A100SDT, A110, A110SDT, A90SDT	5154514	
<b>12841</b>	Cuscinetto reggispinta 90 x 50 x 21,60 mm / Thrust Bearing 90 x 50 x 21,60 mm		35-66,35-66DT,45-66,45-66DT, 446,446DT,466,466DT,480,480DT, 50-66,50-66DT,50-66S,55-66, 50-86,50-86V,50-86VDT,60-86F, 500,500DT,540,540DT,540S,550, 55-46,55-46DT,65-46,65-46DT, 55-66DTLP,60-66,60-66DT,65-66, 55-76F,55-76DT,55-76V,55-76VDT, 55-90,55-90DT,60-90,60-90DT, 566,570,580,600,640,666,670, 60-76F,60-76FDT,70-76DT, 60-86FDT,62-86F,70-86V,72-86F, 65-66DT,70-66,70-66DT,70-66F, 65-90,65-90DT,70-90,70-90DT, 680,766,780,880,880-5,980, 70-66LP,70-66V,80-66,80-66DT, 70-76LP,70-76V,80-76DT,80-76F, 70-86VDT,72-86LP,82-86DT, 72-93,72-93DT,82-93,82-93DT, 72-94,72-94DT,82-94,82-94DT, 80-88,80-88DT,100-90,100-90DT, 80-90,80-90DT,85-90,85-90DT, 82-86F,82-86LP,70-88,70-88DT, 88-93,88-93DT,65-94,65-94DT, 88-94,88-94DT,A100SDT,A110, 90-90,90-90DT,65-93,65-93DT, 980DT,L60,L65,L75,L85,L95, A110SDT,A90SDT	4954935, 5122028, 5157318, 5197980, 82824591, 82824592, 87289219, 87345759, 87541561, 87541562, 9976506	
<b>15545</b>	Cuscinetto pto 115 x 75 x 20 mm / Pto Bearing 115 x 75 x 20 mm		100.90, 100.90DT, 110.90, 110.90DT, 880, 880-5, 90.90, 90.90DT, 980, 980DT, A100SDT, A110, A110SDT, A90SDT, SOM880/4	47127081, 5112084, 5167183	
<b>84028</b>	Kit composto da - Kit consists of: - Meccanismo/Clutch Ref. 5163936 With box Original LUK - Disco Pto/Disc Pto Ref. 5154514 Not Original - Cuscinetto/Bearing Ref. 5122028 Not Original - Cuscinetto/Bearing Ref. 5112084 Not Original	FIAT	100.90, 100.90 DT, 110.90, 110.90 DT, 880.5, 90.90, 90.90 DT, 980, 980DT, A100SDT, A110, A110SDT, A90SDT, SOM880/4	9973696	   
<b>07864</b>	Meccanismo Frizione 12" - Luk Originale		100.90, 100.90DT, 110.90, 880, 880-5,980,980DT, 880/5, 90.90, 90.90DT, 980, A100SDT, A110, A110SDT, A90SDT	5163936	



Art./Ref.	Note/Note	Brand	Applicazione/Application	Rif. Orig./Orig. Ref.	Immagine/Image
26990	Disco Pto Diametro 310 mm - Pto Disc Diameter 310 mm	FIAT	100.90, 100.90DT, 110.90, 880, 880-5,980,980DT, 880/5, 90.90, 90.90DT, 980, A100SDT, A110, A110SDT, A90SDT	5154514	
12841	Cuscinetto reggispinta 90 x 50 x 21,60 mm / Thrust Bearing 90 x 50 x 21,60 mm		35-66,35-66DT,45-66,45-66DT, 446,446DT,466,466DT,480,480DT, 50-66,50-66DT,50-66S,55-66, 50-86,50-86V,50-86VDT,60-86F, 500,500DT,540,540DT,540S,550, 55-46,55-46DT,65-46,65-46DT, 55-66DTLP,60-66,60-66DT,65-66, 55-76F,55-76DT,55-76V,55-76VDT, 55-90,55-90DT,60-90,60-90DT, 566,570,580,600,640,666,670, 60-76F,60-76FDT,70-76DT, 60-86FDT,62-86F,70-86V,72-86F, 65-66DT,70-66,70-66DT,70-66F, 65-90,65-90DT,70-90,70-90DT, 680,766,780,880,880-5,980, 70-66LP,70-66V,80-66,80-66DT, 70-76LP,70-76V,80-76DT,80-76F, 70-86VDT,72-86LP,82-86DT, 72-93,72-93DT,82-93,82-93DT, 72-94,72-94DT,82-94,82-94DT, 80-88,80-88DT,100-90,100-90DT, 80-90,80-90DT,85-90,85-90DT, 82-86F,82-86LP,70-88,70-88DT, 88-93,88-93DT,65-94,65-94DT, 88-94,88-94DT,A100SDT,A110, 90-90,90-90DT,65-93,65-93DT, 980DT,L60,L65,L75,L85,L95, A110SDT,A90SDT	4954935, 5122028, 5157318, 5197980, 82824591, 82824592, 87289219, 87345759, 87541561, 87541562, 9976506	
15545	Cuscinetto pto 115 x 75 x 20 mm / Pto Bearing 115 x 75 x 20 mm		100.90, 100.90DT, 110.90, 110.90DT, 880, 880-5, 90.90, 90.90DT, 980, 980DT, A100SDT, A110, A110SDT, A90SDT, SOM880/4	47127081, 5112084, 5167183	
LUK631106810	Kit tutto originale LUK composto da - Kit all LUK original consists of: - Meccanismo/Clutch Ref. 231 0049 19 - Disco Pto/Disc Pto 331 0132 16 - Cuscinetto/Bearing Ref. 500 0459 00 - Cuscinetto/Bearing Ref. 500 1292 10 - Cuscinetto/Bearing Ref. 410 0026 00	FIAT	100.90, 100.90 DT, 110.90, 110.90 DT, 880.5, 90.90, 90.90 DT, 980, 980DT, A100SDT, A110, A110SDT, A90SDT, SOM880/4	9973696	
07864	Meccanismo Frizione 12" - Luk Originale		100.90, 100.90DT, 110.90, 880, 880-5,980,980DT, 880/5, 90.90, 90.90DT, 980, A100SDT, A110, A110SDT, A90SDT	5163936	
07866	Disco Pto Diametro 310 mm Luk originale - Pto Disc Diameter 310 mm Original Luk		100.90, 100.90DT, 110.90, 880, 880-5,980,980DT, 880/5, 90.90, 90.90DT, 980, A100SDT, A110, A110SDT, A90SDT	5154514	
LUK500045900	Cuscinetto reggispinta 90 x 50 x 21,60 mm / Thrust Bearing 90 x 50 x 21,60 mm		35-66,35-66DT,45-66,45-66DT, 446,446DT,466,466DT,480,480DT, 50-66,50-66DT,50-66S,55-66, 50-86,50-86V,50-86VDT,60-86F, 500,500DT,540,540DT,540S,550, 55-46,55-46DT,65-46,65-46DT, 55-66DTLP,60-66,60-66DT,65-66, 55-76F,55-76DT,55-76V,55-76VDT, 55-90,55-90DT,60-90,60-90DT, 566,570,580,600,640,666,670, 60-76F,60-76FDT,70-76DT, 60-86FDT,62-86F,70-86V,72-86F, 65-66DT,70-66,70-66DT,70-66F, 65-90,65-90DT,70-90,70-90DT, 680,766,780,880,880-5,980, 70-66LP,70-66V,80-66,80-66DT, 70-76LP,70-76V,80-76DT,80-76F, 70-86VDT,72-86LP,82-86DT, 72-93,72-93DT,82-93,82-93DT, 72-94,72-94DT,82-94,82-94DT, 80-88,80-88DT,100-90,100-90DT, 80-90,80-90DT,85-90,85-90DT, 82-86F,82-86LP,70-88,70-88DT, 88-93,88-93DT,65-94,65-94DT, 88-94,88-94DT,A100SDT,A110, 90-90,90-90DT,65-93,65-93DT, 980DT,L60,L65,L75,L85,L95, A110SDT,A90SDT	4954935, 5122028, 5157318, 5197980, 82824591, 82824592, 87289219, 87345759, 87541561, 87541562, 9976506	
LUK500129210	Cuscinetto pto 115 x 75 x 20 mm / Pto Bearing 115 x 75 x 20 mm		100.90, 100.90DT, 110.90, 110.90DT, 880, 880-5, 90.90, 90.90DT, 980, 980DT, A100SDT, A110, A110SDT, A90SDT, SOM880/4	47127081, 5112084, 5167183	
LUK410002600	Cuscinetto volano 47 x 20 x 14 mm - Bearing 47 x 20 x 14 mm		115-90,15-90DT,130-90,130-90DT, 1180,1180DT,1280,1280DT, 1380,1380DT,1580,1580DT,, 140-90,140-90DT, 160-90,160-90DT, 180-90,180-90DT, 1880,1880DT,, A140,A140DT	28042740	



**MECCANISMO + DISCO PTO ORIGINALE LUK RIF. 623099109**

MECANISME + DISQUE PTO ORIGINAL LUK 623099109  
 COVER ASSEMBLY + ORIGINAL PTO DISC LUK REF. 623099109  
 GETRIEBE + ZAPFWELLENSCHEIBE LUK 623099109  
 MECANISMO + DISCO PTO ORIGINAL LUK REF. 623099109

Art./Ref.	Note/Note	Brand	Applicazione/Application	Rif. Orig./Orig. Ref.	Immagine/Image
<b>LUK623099109</b>	Kit tutto originale LUK composto da - Kit all LUK original consists of: - Meccanismo/Clutch Ref. 223 0024 10 - Disco Pto/Disc Pto 323 0307 10	<b>FIAT</b>	35.66	44907615, 44907617	 
<b>LUK223002410</b>	Meccanismo Frizione 9" - Luk originale		35.66	44907615	
<b>LUK323030710</b>	Disco Pto Diametro 225 mm Luk originale - Pto Disc Diameter 225 mm Original Luk		35.66	44907617	
<b>LUK500045900</b>	Cuscinetto reggispinta 90 x 50 x 21,60 mm Thrust Bearing 90 x 50 x 21,60 mm		35-66,35-66DT,45-66,45-66DT, 446,446DT,466,466DT,480,480DT, 50-66,50-66DT,50-66S,55-66,50-86,50-86V,50-86VDT,60-86F, 500,500DT,540,540DT,540S,550,55-46,55-46DT,65-46,65-46DT, 55-66DTLP,60-66,60-66DT,65-66, 55-76F,55-76DT,55-76V,55-76VDT, 55-90,55-90DT,60-90,60-90DT, 566,570,580,600,640,666,670,60-76F,60-76FDT,70-76DT, 60-86FDT,62-86F,70-86V,72-86F, 65-66DT,70-66,70-66DT,70-66F, 65-90,65-90DT,70-90,70-90DT, 680,766,780,880,880-5,980, 70-66LP,70-66V,80-66,80-66DT, 70-76LP,70-76V,80-76DT,80-76F, 70-86VDT,72-86LP,82-86DT, 72-93,72-93DT,82-93,82-93DT, 72-94,72-94DT,82-94,82-94DT, 80-88,80-88DT,100-90,100-90DT, 80-90,80-90DT,85-90,85-90DT, 82-86F,82-86LP,70-88,70-88DT, 88-93,88-93DT,65-94,65-94DT, 88-94,88-94DT,A100SDT,A110, 90-90,90-90DT,65-93,65-93DT, 980DT,L60,L65,L75,L85,L95, A110SDT,A90SDT	4954935, 5122028, 5157318, 5197980, 82824591, 82824592, 87289219, 87345759, 87541561, 87541562, 9976506	
<b>LUK500067300</b>	Cuscinetto pto 100 x 65 x 18 mm / Pto Bearing 100 x 65 x 18 mm		35.66, 45.66 - 45.66DT, 45.66S - 45.66S DT, 45.76 V, 50.66 - 50.66DT, 50.66S - 50.66S DT, 50.86S V - 50.86S V DT, 50.86V - 50.86V DT, 55.66 V - 55.66 V DT, 55.66F - 55.66F DT, 55.76F - 55.76F DT, 55.76V - 55.76V DT, 55.86F - 55.86F DT, 55.86S V - 55.86S V DT, 55.86V - 55.86V DT	24905350	

**MECCANISMO + DISCO PTO ORIGINALE LUK RIF. 625141909**

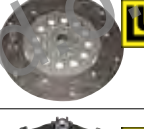
MECANISME + DISQUE PTO ORIGINAL LUK 625141909  
 COVER ASSEMBLY + ORIGINAL PTO DISC LUK REF. 625141909  
 GETRIEBE + ZAPFWELLENSCHEIBE LUK 625141909  
 MECANISMO + DISCO PTO ORIGINAL LUK REF. 625141909

Art./Ref.	Note/Note	Brand	Applicazione/Application	Rif. Orig./Orig. Ref.	Immagine/Image
<b>LUK625141909</b>	Kit tutto originale LUK composto da - Kit all LUK original consists of: - Meccanismo/Clutch Ref. 225 0049 12 - Disco Pto/Disc Pto 325 0118 16	<b>FIAT</b>	45.66 - 45.66DT, 45.66S - 45.66S DT, 45.76 V, 50.66 - 50.66DT, 50.66S - 50.66S DT, 50.86S V - 50.86S V DT, 50.86V - 50.86V DT, 55.66 V - 55.66 V DT, 55.66F - 55.66F DT, 55.76F - 55.76F DT, 55.76V - 55.76V DT, 55.86F - 55.86F DT, 55.86S V - 55.86S V DT, 55.86V - 55.86V DT	5128074, 5139339, 5154513, 5154799, 5171493	 
<b>26858</b>	Meccanismo Frizione 10" - Luk Originale		45.66 - 45.66DT, 45.66S - 45.66S DT, 45.76 V, 50.66 - 50.66DT, 50.66S - 50.66S DT, 50.86S V - 50.86S V DT, 50.86V - 50.86V DT, 55.66 V - 55.66 V DT, 55.66F - 55.66F DT, 55.76F - 55.76F DT, 55.76V - 55.76V DT, 55.86F - 55.86F DT, 55.86S V - 55.86S V DT, 55.86V - 55.86V DT	5139339, 5154513, 5171493	

Art./Ref.	Note/Note	Brand	Applicazione/Application	Rif. Orig./Orig. Ref.	Immagine/Image
27384	Disco Pto Diametro 250 mm Luk originale - Pto Disc Diameter 250 mm Original Luk	FIAT	45.66 - 45.66DT, 45.66S - 45.66S DT, 45.76V, 50.66 - 50.66DT, 50.66S - 50.66S DT, 50.86S V - 50.86S V DT, 50.86V - 50.86V DT, 55.76F - 55.76F DT, 55.76V - 55.76V DT, 55.86F - 55.86F DT, 55.86S V - 55.86S V DT, 55.86V - 55.86V DT	5128074, 5154799	
LUK500045900	Cuscinetto reggispinta 90 x 50 x 21,60 mm / Thrust Bearing 90 x 50 x 21,60 mm		35-66,35-66DT,45-66,45-66DT, 446,446DT,466,466DT,480,480DT, 50-66,50-66DT,50-66S,55-66, 50-86,50-86V,50-86VDT,60-86F, 500,500DT,540,540DT,540S,550, 55-46,55-46DT,65-46,65-46DT, 55-66DTLP,60-66,60-66DT,65-66, 55-76F,55-76DT,55-76V,55-76VDT, 55-90,55-90DT,60-90,60-90DT, 566,570,580,600,640,666,670, 60-76F,60-76FDT,70-76DT, 60-86FDT,62-86F,70-86V,72-86F, 65-66DT,70-66,70-66DT,70-66F, 65-90,65-90DT,70-90,70-90DT, 680,766,780,880,880-5,980, 70-66LP,70-66V,80-66,80-66DT, 70-76LP,70-76V,80-76DT,80-76F, 70-86VDT,72-86LP,82-86DT, 72-93,72-93DT,82-93,82-93DT, 72-94,72-94DT,82-94,82-94DT, 80-88,80-88DT,100-90,100-90DT, 80-90,80-90DT,85-90,85-90DT, 82-86F,82-86LP,70-88,70-88DT, 88-93,88-93DT,65-94,65-94DT, 88-94,88-94DT,A100SDT,A110, 90-90,90-90DT,65-93,65-93DT, 980DT,L60,L65,L75,L85,L95, A110SDT,A90SDT	4954935, 5122028, 5157318, 5197980, 82824591, 82824592, 87289219, 87345759, 87541561, 87541562, 9976506	
LUK500067300	Cuscinetto pto 100 x 65 x 18 mm / Pto Bearing 100 x 65 x 18 mm		35.66, 45.66 - 45.66DT, 45.66S - 45.66S DT, 45.76 V, 50.66 - 50.66DT, 50.66S - 50.66S DT, 50.86S V - 50.86S V DT, 50.86V - 50.86V DT, 55.66 V - 55.66 V DT, 55.66F - 55.66F DT, 55.76F - 55.76F DT, 55.76V - 55.76V DT, 55.86F - 55.86F DT, 55.86S V - 55.86S V DT, 55.86V - 55.86V DT	24905350	
LUK410002500	Cuscinetto volano 47 x 17 x 14 mm - Bearing 47 x 17 x 14 mm		35-66,35-66DT,45-66,45-66DT, 446,446DT,466,466DT,480,480DT, 50-66,50-66DT,50-66S,55-66, 50-86,50-86V,50-86VDT,60-86F, 500,500DT,540,540DT,540S,550, 55-46,55-46DT,65-46,65-46DT, 55-66DTLP,60-66,60-66DT,65-66, 55-76F,55-76DT,55-76V,55-76VDT, 55-90,55-90DT,60-90,60-90DT, 566,570,580,600,640,666,670, 60-76F,60-76FDT,70-76DT, 60-86FDT,62-86F,70-86V,72-86F, 65-66DT,70-66,70-66DT,70-66F, 65-90,65-90DT,70-90,70-90DT, 680,766,780,880,880-5,980, 70-66LP,70-66V,80-66,80-66DT, 70-76LP,70-76V,80-76DT,80-76F, 70-86VDT,72-86LP,82-86DT, 72-93,72-93DT,82-93,82-93DT, 72-94,72-94DT,82-94,82-94DT, 80-88,80-88DT,100-90,100-90DT, 80-90,80-90DT,85-90,85-90DT, 82-86F,82-86LP,70-88,70-88DT, 88-93,88-93DT,65-94,65-94DT, 88-94,88-94DT,A100SDT,A110, 90-90,90-90DT,65-93,65-93DT, 980DT,L60,L65,L75,L85,L95, A110SDT,A90SDT	28043280	

**MECCANISMO + DISCO AVANZAMENTO ORIGINALE LUK RIF. 635068609**

MECANISME + DISQUE AVANCEMENT ORIGINAL LUK 635068609  
 COVER ASSEMBLY + ORIGINAL MAIN DRIVE LUK REF. 635068609  
 GETRIEBE + VORSCHIEBE LUK 635068609  
 MECANISMO + DISCO DE AVANCE ORIGINAL LUK REF. 635068609

Art./Ref.	Note/Note	Brand	Applicazione/Application	Rif. Orig./Orig. Ref.	Immagine/Image
LUK635068609	Kit tutto originale LUK composto da - Kit all LUK original consists of: - Meccanismo/Clutch Ref. 135 0215 10 - Disco Avanzamento/Clutch Disc 335 0129 10	FIAT	F130 - F130DT, F140 - F140DT	5150079, 5165648, 5177620	
16915	Meccanismo Frizione 14" - Luk originale		F130 - F130DT, F140 - F140DT	5150079, 5177620	
07880	Disco avanzamento 350 mm a 6 pale Luk originale - Clutch Disc Diameter 350 mm 6 pairs of pads Original Luk		F130 - F130DT, F140 - F140DT	5165648	
LUK500085130	Cuscinetto reggispinta completo 115 x 65 x 30 mm / Bearing + carrier assy 115 x 65 x 30 mm		F130 - F130DT, F140 - F140DT	5149611, 9967339	

**MECCANISMO + DISCO AVANZAMENTO ORIGINALE LUK RIF. 635114309**

MECANISME + DISQUE AVANCEMENT ORIGINAL LUK 635114309

COVER ASSEMBLY + ORIGINAL MAIN DRIVE LUK REF. 635114309

GETRIEBE + VORSCHLEIBE LUK 635114309

MECANISMO + DISCO DE AVANCE ORIGINAL LUK REF. 635114309

Art./Ref.	Note/Note	Brand	Applicazione/Application	Rif. Orig./Orig. Ref.	Immagine/Image
<b>LUK635114309</b>	Kit tutto originale LUK composto da - Kit all LUK original consists of: - Meccanismo/Clutch Ref. 135 0215 10 - Disco Avanzamento/Clutch Disc 335 0006 10	<b>FIAT</b>	115.90-115.90DT, 1180-1180DT, 1280-1280DT, 130.90-130.90DT, 1380-1380DT, 140.90-140.90DT, 1580-1580DT, 1880-1880DT, A140 - A140DT	5112400, 5112564, 5112843, 5113135, 5118453, 5123061, 5123062, 5124031	
<b>07873</b>	Meccanismo Frizione 14" - Luk originale		115.90-115.90DT, 1180-1180DT, 1280-1280DT, 130.90-130.90DT, 1380-1380DT, 140.90-140.90DT, 1580-1580DT, 1880-1880DT, A140 - A140DT	5112400, 5112564, 5112843, 5113135, 5123061, 5123062, 5124031	
<b>07874</b>	Disco avanzamento 350 mm a 8 pale Luk originale - Clutch Disc Diameter 350 mm 8 pairs of pads Original Luk		115.90-115.90DT, 1180-1180DT, 1280-1280DT, 130.90-130.90DT, 1380-1380DT, 140.90-140.90DT, 1580-1580DT, 1880-1880DT, A140 - A140DT	5118453	

**KIT FRIZIONE LUK ADATTABILE RIF. 87689658 FIAT**

KIT EMBRAYAGE LUK ADAPTABLE REF. 87689658 FIAT

KIT CLUTCH LUK ADAPTABLE REF. 87689658 FIAT

KIT KUPPLUNG LUK PASSEND ZU REF. 87689658 FIAT

KIT EMBRAGUE LUK ADAPTABLE REF. 87689658 FIAT

Art./Ref.	Note/Note	Brand	Applicazione/Application	Rif. Orig./Orig. Ref.	Immagine/Image
<b>LUK628105210</b>	Kit tutto originale LUK composto da - Kit all LUK original consists of - Meccanismo/Clutch Ref. 228 0093 11 - Disco Pto/Disc Pto 328 0253 10 - Cuscinetto/Bearing Ref. 500 0459 00 - Cuscinetto/Bearing Ref. 500 0673 00 - Cuscinetto/Bearing Ref. 410 0025 00	<b>FIAT</b>	50.86S - 50.86V, 56.66S - 56.66S DT, 60.86F - 60.86F DT, 60.86S - 60.86S DT, 60.86V - 60.86V DT, 70.86S V - 70.86S V DT, 70.86V - 70.86V DT	87689658	
<b>LUK628105209</b>	Kit tutto originale LUK composto da - Kit all LUK original consists of: - Meccanismo/Clutch Ref. 228 0093 11 - Disco Pto/Disc Pto 328 0253 10		50.86S - 50.86V, 56.66S - 56.66S DT, 60.86F - 60.86F DT, 60.86S - 60.86S DT, 60.86V - 60.86V DT, 70.86S V - 70.86S V DT, 70.86V - 70.86V DT	44900044, 47512407, 5171494	

Art./Ref.	Note/Note	Brand	Applicazione/Application	Rif. Orig./Orig. Ref.	Immagine/Image
LUK500045900	Cuscinetto reggispinta 90 x 50 x 21,60 mm / Thrust Bearing 90 x 50 x 21,60 mm	FIAT	35-66,35-66DT,45-66,45-66DT, 446,446DT,466,466DT,480,480DT, 50-66,50-66DT,50-66S,55-66, 50-86,50-86V,50-86VDT,60-86F, 500,500DT,540,540DT,540S,550, 55-46,55-46DT,65-46,65-46DT, 55-66DTLP,60-66,60-66DT,65-66, 55-76F,55-76DT,55-76V,55-76VDT, 55-90,55-90DT,60-90,60-90DT, 566,570,580,600,640,666,670, 60-76F,60-76FDT,70-76DT, 60-86FDT,62-86F,70-86V,72-86F, 65-66DT,70-66,70-66DT,70-66F, 65-90,65-90DT,70-90,70-90DT, 680,766,780,880,880-5,980, 70-66LP,70-66LP,80-66,80-66DT, 70-76LP,70-76V,80-76DT,80-76F, 70-86VDT,72-86LP,82-86DT, 72-93,72-93DT,82-93,82-93DT, 72-94,72-94DT,82-94,82-94DT, 80-88,80-88DT,100-90,100-90DT, 80-90,80-90DT,85-90,85-90DT, 82-86F,82-86LP,70-88,70-88DT, 88-93,88-93DT,65-94,65-94DT, 88-94,88-94DT,A100SDT,A110, 90-90,90-90DT,65-93,65-93DT, 980DT,L60,L65,L75,L85,L95, A110SDT,A90SDT	4954935, 5122028, 5157318, 5197980, 82824591, 82824592, 87289219, 87345759, 87541561, 87541562, 9976506	
LUK500067300	Cuscinetto pto 100 x 65 x 18 mm / Pto Bearing 100 x 65 x 18 mm		35.66, 45.66 - 45.66DT, 45.66S - 45.66S DT, 45.76 V, 50.66 - 50.66DT, 50.66S - 50.66S DT, 50.86S V - 50.86S V DT, 50.86V - 50.86V DT, 55.66 V - 55.66 V DT, 55.66F - 55.66F DT, 55.76F - 55.76F DT, 55.76V - 55.76V DT, 55.86F - 55.86F DT, 55.86S V - 55.86S V DT, 55.86V - 55.86V DT	24905350	
LUK410002500	Cuscinetto volano 47 x 17 x 14 mm - Bearing 47 x 17 x 14 mm		35-66,35-66DT,45-66,45-66DT, 446,446DT,466,466DT,480,480DT, 50-66,50-66DT,50-66S,55-66, 50-86,50-86V,50-86VDT,60-86F, 500,500DT,540,540DT,540S,550, 55-46,55-46DT,65-46,65-46DT, 55-66DTLP,60-66,60-66DT,65-66, 55-76F,55-76DT,55-76V,55-76VDT, 55-90,55-90DT,60-90,60-90DT, 566,570,580,600,640,666,670, 60-76F,60-76FDT,70-76DT, 60-86FDT,62-86F,70-86V,72-86F, 65-66DT,70-66,70-66DT,70-66F, 65-90,65-90DT,70-90,70-90DT, 680,766,780,880,880-5,980, 70-66LP,70-66V,80-66,80-66DT, 70-76LP,70-76V,80-76DT,80-76F, 70-86VDT,72-86LP,82-86DT, 72-93,72-93DT,82-93,82-93DT, 72-94,72-94DT,82-94,82-94DT, 80-88,80-88DT,100-90,100-90DT, 80-90,80-90DT,85-90,85-90DT, 82-86F,82-86LP,70-88,70-88DT, 88-93, 88-93DT,65-94,65-94DT, 88-94,88-94DT,A100SDT,A110, 90-90,90-90DT,65-93, 65-93DT, 980DT,L60,L65,L75,L85,L95, A110SDT,A90SDT	28043280	

**KIT FRIZIONE LUK ADATTABILE RIF. 87689657 FIAT**

KIT EMBRAYAGE LUK ADAPTABLE REF. 87689657 FIAT

KIT CLUTCH LUK ADAPTABLE REF. 87689657 FIAT

KIT KUPPLUNG LUK PASSEND ZU REF. 87689657 FIAT

KIT EMBRAGUE LUK ADAPTABLE REF. 87689657 FIAT

Art./Ref.	Note/Note	Brand	Applicazione/Application	Rif. Orig./Orig. Ref.	Immagine/Image
LUK628103410	Kit tutto originale LUK composto da - Kit all LUK original consists of: - Meccanismo/Clutch Ref. 228 0077 17 - Disco Pto/Disc Pto 328 0186 16 - Cuscinetto/Bearing Ref. 500 0459 00 - Cuscinetto/Bearing Ref. 500 0284 00 - Cuscinetto/Bearing Ref. 410 0025 00	FIAT	446 - 450S - 466 - 480, 500 - 530 - 540 - 550, 55.46-55.46 DT, 55.56-55.56 DT, 55.66-55.66 DT, 55.66S-55.66S DT, 55.88-55.88 DT, 55.90-55.90 DT, 566 - 570 - 580 - 600, 60.46-60.46 DT, 60.56-60.56 DT, 60.66-60.66 DT, 60.66S-60.66S DT, 60.76F-60.76F DT, 60.88-60.88 DT, 60.90-60.90 DT, 60.93-60.93 DT, 60.94-60.94 DT, 62.86F-62.86F DT, 640 - 666 - 670 - 680, 65.46-65.46 DT, 65.56-65.56 DT, 65.66S-65.66S DT, 65.88-65.88 DT, 65.90-65.90 DT, 65.93-65.93 DT, 65.94-65.94 DT, 70.56-70.56 DT, 70.66-70.66 DT, 70.66S-70.66S DT, 70.76F-70.76F DT, 70.76LP-70.76LP DT, 70.88-70.88 DT, 70.90-70.90 DT, 72.86F-72.86F DT, 72.86LP-72.86LP DT, 72.93-72.93 DT, 72.94-72.94 DT, 740 - 766 - 780, 80.66F-80.66F DT, 80.66S-80.66S DT, 80.76-80.76 DT, 80.76F-80.76F DT, 80.88-80.88 DT, 80.90-80.90 DT, 82.86F-82.86F DT, 82.86LP-82.86LP DT, 82.93-82.93 DT, 82.94-82.94 DT, 85.90-85.90 DT, 88.93-88.93 DT, 88.94-88.94 DT	87689657	
07850	Meccanismo Frizione 11" - Luk originale		446 - 450S - 466 - 480, 500 - 530 - 540 - 550, 55.46-55.46 DT, 55.56-55.56 DT, 55.66-55.66 DT, 55.66S-55.66S DT, 55.88-55.88 DT, 55.90-55.90 DT, 566 - 570 - 580 - 600, 60.46-60.46 DT, 60.56-60.56 DT, 60.66-60.66 DT, 60.66S-60.66S DT, 60.76F-60.76F DT, 60.88-60.88 DT, 60.90-60.90 DT, 60.93-60.93 DT, 60.94-60.94 DT, 62.86F-62.86F DT, 640 - 666 - 670 - 680, 65.46-65.46 DT, 65.56-65.56 DT, 65.66S-65.66S DT, 65.88-65.88 DT, 65.90-65.90 DT, 65.93-65.93 DT, 65.94-65.94 DT, 70.56-70.56 DT, 70.66-70.66 DT, 70.66S-70.66S DT, 70.76F-70.76F DT, 70.76LP-70.76LP DT, 70.88-70.88 DT, 70.90-70.90 DT, 72.86F-72.86F DT, 72.86LP-72.86LP DT, 72.93-72.93 DT, 72.94-72.94 DT, 740 - 766 - 780, 80.66F-80.66F DT, 80.66S-80.66S DT, 80.76-80.76 DT, 80.76F-80.76F DT, 80.88-80.88 DT, 80.90-80.90 DT, 82.86F-82.86F DT, 82.86LP-82.86LP DT, 82.93-82.93 DT, 82.94-82.94 DT, 85.90-85.90 DT, 88.93-88.93 DT, 88.94-88.94 DT	47512408, 5154879, 5171137	
07852	Disco Pto Diametro 280 mm Luk originale - Pto Disc Diameter 280 mm Original Luk		440,446,450UTB,480,480/8,500S, 55.46,55.56,55.66,55.66LP, 550,870,570V,570F,580,600,640, 60.66,60.88,60.90,65.88,65.90, 60.66S,60.88,62.86F,65.66, 65.46,65.66,65.56L,70.56,70.66, 65.90,65.93,65.94,70.56,70.66, 670,670F,680,780, 70.66LP,70.90,80.66,80.66F, 70.76,72.86,80.76,82.86,80.90, 70.90,85.90,82.93,82.94,88.93, 88.94,55.66,55.88,55.90,60.46	5145715, 5154703	

Art./Ref.	Note/Note	Brand	Applicazione/Application	Rif. Orig./Orig. Ref.	Immagine/Image
<b>LUK500045900</b>	Cuscinetto reggispira 90 x 50 x 21,60 mm / Thrust Bearing 90 x 50 x 21,60 mm		35-66,35-66DT,45-66,45-66DT, 446,446DT,466,466DT,480,480DT, 50-66,50-66DT,50-66S,55-66, 50-86,50-86V,50-86VDT,60-86F, 500,500DT,540,540DT,540S,550, 55-46,55-46DT,65-46,65-46DT, 55-66DTLP,60-66,60-66DT,65-66, 55-76F,55-76DT,55-76V,55-76VDT, 55-90,55-90DT,60-90,60-90DT, 566,570,580,600,640,666,670, 60-76F,60-76FDT,70-76DT, 60-86FDT,62-86F,70-86V,72-86F, 65-66DT,70-66,70-66DT,70-66F, 65-90,65-90DT,70-90,70-90DT, 680,766,780,880,880-5,980, 70-66LP,70-66V,80-66,80-66DT, 70-76LP,70-76V,80-76DT,80-76F, 70-86VDT,72-86LP,82-86DT, 72-93,72-93DT,82-93,82-93DT, 72-94,72-94DT,82-94,82-94DT, 80-88,80-88DT,100-90,100-90DT, 80-90,80-90DT,85-90,85-90DT, 82-86F,82-86LP,70-88,70-88DT, 88-93,88-93DT,65-94,65-94DT, 88-94,88-94DT,A100SDT,A110, 90-90,90-90DT,65-93,65-93DT, 980DT,L60,L65,L75,L85,L95, A110SDT,A90SDT	4954935, 5122028, 5157318, 5197980, 82824591, 82824592, 87289219, 87345759, 87541561, 87541562, 9976506	
<b>LUK500028400</b>	Cuscinetto pto 110 x 70 x 20 mm / Pto Bearing 110 x 70 x 20 mm	<b>FIAT</b>	115.90-115.90DT, 130.90-130.90DT, 140.90-140.90DT, 160.90-160.90DT, 180.90-180.90DT, 446-446DT, 466-466DT, 480-480DT, 500-500DT, 540-540DT-540S, 55.46, 55.48, 55.55, 55.56, 55.56LM, 55.60, 55.65, 55.66, 55.66LP, 55.66LP, 55.70, 55.88, 55.90, 550, 566, 570, 570F, 570V, 580, 60.46, 60.56, 60.66, 60.66F, 60.66LP, 60.66S, 60.76, 60.76F, 60.88, 60.90, 60.90/LPF, 60.93, 60.94, 600, 601IF,701IF,801IF, 62.86, 62.86F, 640, 65.46, 65.56, 65.56L, 65.66, 65.66F, 65.66S, 65.66V, 65.88, 65.90, 65.90L, 65.93, 65.94, 666, 666DT, 670, 670F, 680, 70.56, 70.66, 70.66LP, 70.66LP/F, 70.66S, 70.66V, 70.76, 70.76F, 70.76LP, 70.76V, 70.88, 70.90, 70.90/LPF, 72.86, 72.86LP, 72.93, 72.94, 740, 766, 780, 80.46, 80.56, 80.60, 80.66, 80.66F, 80.66S, 80.70, 80.75, 80.76, 80.85, 80.88, 80.90, 80/FL, 82.86, 82.86LP, 82.93, 82.93DT, 82.94, 82.94DT, 85.90, 88.93, 88.93DT, 88.94, 88.94DT, 880, 90/LP	21905360	
<b>LUK410002500</b>	Cuscinetto volano 47 x 17 x 14 mm - Bearing 47 x 17 x 14 mm		35-66,35-66DT,45-66,45-66DT, 446,446DT,466,466DT,480,480DT, 50-66,50-66DT,50-66S,55-66, 50-86,50-86V,50-86VDT,60-86F, 500,500DT,540,540DT,540S,550, 55-46,55-46DT,65-46,65-46DT, 55-66DTLP,60-66,60-66DT,65-66, 55-76F,55-76DT,55-76V,55-76VDT, 55-90,55-90DT,60-90,60-90DT, 566,570,580,600,640,666,670, 60-76F,60-76FDT,70-76DT, 60-86FDT,62-86F,70-86V,72-86F, 65-66DT,70-66,70-66DT,70-66F, 65-90,65-90DT,70-90,70-90DT, 680,766,780,880,880-5,980, 70-66LP,70-66V,80-66,80-66DT, 70-76LP,70-76V,80-76DT,80-76F, 70-86VDT,72-86LP,82-86DT, 72-93,72-93DT,82-93,82-93DT, 72-94,72-94DT,82-94,82-94DT, 80-88,80-88DT,100-90,100-90DT, 80-90,80-90DT,85-90,85-90DT, 82-86F,82-86LP,70-88,70-88DT, 88-93,88-93DT,65-94,65-94DT, 88-94,88-94DT,A100SDT,A110, 90-90,90-90DT,65-93,65-93DT, 980DT,L60,L65,L75,L85,L95, A110SDT,A90SDT	28043280	

**KIT FRIZIONE LUK ORIGINALE RIF. 631107010**

KIT EMBRAYAGE LUK ORIGINAL REF. 631107010

KIT CLUTCH ORIGINAL LUK REF. 631107010

KIT KUPPLUNG LUK REF. 631107010

KIT EMBRAGUE LUK ORIGINAL REF. 631107010

Art./Ref.	Note/Note	Brand	Applicazione/Application	Rif. Orig./Orig. Ref.	Immagine/Image
<b>LUK631107010</b>	Kit tutto originale LUK composto da - Kit all LUK original consists of: - Meccanismo/Clutch Ref. 231 0050 10 - Disco Pto/Disc Pto 331 0130 16 - Cuscinetto/Bearing Ref. 500 0059 10 - Cuscinetto/Bearing Ref. 500 0058 10 - Cuscinetto/Bearing Ref. 410 0026 00	<b>FIAT</b>	115.90, 115.90DT, 1180, 1180DT	28042740, 44016827, 5113067, 5116210, 5118216, 5120853, 5122097, 5122098, 5144661, 5154551	
<b>07870</b>	Meccanismo Frizione 12" - Luk Originale		115.90, 115.90DT, 1180, 1180DT	5113067, 5116210, 5118216, 5122097, 5122098, 5144661	
<b>07872</b>	Disco Pto Diametro 310 mm Luk originale - Pto Disc Diameter 310 mm Original Luk		115-90,115-90DT, 1180,1180DT	5144662, 5154551	

Art./Ref.	Note/Note	Brand	Applicazione/Application	Rif. Orig./Orig. Ref.	Immagine/Image
12846	Cuscinetto reggispinta 97 x 65 x 19 mm / Thrust Bearing 97 x 65 x 19 mm		1000,1000DT, 115-90,115-90DT, 1180,1180DT, 1580,1580DT,1880,1880DT, 160-90,160-90DT,, 180-90,180-90DT, 570N/DT, 670N/DT	5120853	
LUK500005810	Cuscinetto pto 140 x 106 x 21 mm / Pto Bearing 140 x 106 x 21 mm	FIAT	1000 DT, 1000 SUPER, 115.90, 115.90DT, 1180, 1180DT, 570N/DT, 670N/DT	44016827	
LUK410002600	Cuscinetto volano 47 x 20 x 14 mm - Bearing 47 x 20 x 14 mm		1000 DT, 1000 SUPER, 115-90,15-90DT,130-90,130-90DT, 1180,1180DT,1280,1280DT,, 1380,1380DT,1580,1580DT,, 140-90,140-90DT, 160-90,160-90DT, 180-90,180-90DT, 1880,1880DT,, 570N/DT, 670N/DT, A140,A140DT	28042740	

**KIT FRIZIONE LUK ORIGINALE RIF. MECCANISMO 5114526**

KIT EMBRAYAGE LUK ORIGINAL REF. 5114526

KIT CLUTCH ORIGINAL LUK REF. 5114526

KIT KUPPLUNG LUK REF. 5114526

KIT EMBRAGUE LUK ORIGINAL REF. 5114526

Art./Ref.	Note/Note	Brand	Applicazione/Application	Rif. Orig./Orig. Ref.	Immagine/Image
26859	Meccanismo Frizione 11" - Luk originale		840, 850, 880 1° TIPO	5104215, 5114526, 5160430	
29412	Disco Pto Diametro 280 mm Luk originale - Pto Disc Diameter 280 mm Original Luk		840, 850, 880 1° TIPO	5102263, 5160410, 9930401	
LUK500045900	Cuscinetto reggispinta 90 x 50 x 21,60 mm / Thrust Bearing 90 x 50 x 21,60 mm	FIAT	35-66,35-66DT,45-66,45-66DT, 446,446DT,466,466DT,480,480DT, 50-66,50-66DT,50-66S,55-66, 50-86,50-86V,50-86VDT,60-86F, 500,500DT,540,540DT,540S,550, 55-46,55-46DT,65-46,65-46DT, 55-66DTLP,60-66,60-66DT,65-66, 55-76F,55-76DT,55-76V,55-76VDT, 55-90,55-90DT,60-90,60-90DT, 566,570,580,600,640,666,670, 60-76F,60-76FDT,70-76DT, 60-86FDT,62-86F,70-86V,72-86F, 65-66DT,70-66,70-66DT,70-66F, 65-90,65-90DT,70-90,70-90DT, 680,766,780,880,880-5,980, 70-66LP,70-66V,80-66,80-66DT, 70-76LP,70-76V,80-76DT,80-76F, 70-86VDT,72-86LP,82-86DT, 72-93,72-93DT,82-93,82-93DT, 72-94,72-94DT,82-94,82-94DT, 80-88,80-88DT,100-90,100-90DT, 80-90,80-90DT,85-90,85-90DT, 82-86F,82-86LP,70-88,70-88DT, 840, 850, 88-93,88-93DT,65-94,65-94DT, 88-94,88-94DT,A100SDT,A110, 90-90,90-90DT,65-93,65-93DT, 980DT,L60,L65,L75,L85,L95, A110SDT,A90SDT	4954935, 5122028, 5157318, 5197980, 82824591, 82824592, 87289219, 87345759, 87541561, 87541562, 9976506	
LUK500028400	Cuscinetto pto 110 x 70 x 20 mm / Pto Bearing 110 x 70 x 20 mm		115.90-115.90DT, 130.90-130.90DT, 140.90-140.90DT, 160.90-160.90DT, 180.90-180.90DT, 446-446DT, 466-466DT, 480-480DT, 500-500DT, 540-540DT-540S, 55.46, 55.48, 55.55, 55.56, 55.56LM, 55.60, 55.65, 55.66, 55.66 LP, 55.66LP, 55.70, 55.88, 55.90, 550, 566, 570, 570F, 570V, 580, 60.46, 60.56, 60.66, 60.66F, 60.66LP, 60.66S, 60.76, 60.76F, 60.88, 60.90, 60.90/LPF, 60.93, 60.94, 600, 601IF,701IF,801IF, 62.86, 62.86F, 640, 65.46, 65.56, 65.56L, 65.66, 65.66F, 65.66S, 65.66V, 65.88, 65.90, 65.90L, 65.93, 65.94, 666, 666DT, 670, 670F, 680, 70.56, 70.66, 70.66LP, 70.66LP/F, 70.66S, 70.66V, 70.76, 70.76F, 70.76LP, 70.76V, 70.88, 70.90, 70.90/LPF, 72.86, 72.86LP, 72.93, 72.94, 740, 766, 780, 80.46, 80.56, 80.60, 80.66, 80.66F, 80.66S, 80.70, 80.75, 80.76, 80.85, 80.88, 80.90, 80/FL, 82.86, 82.86LP, 82.93, 82.93DT, 82.94, 82.94DT, 840, 85.90, 850, 88.93, 88.93DT, 88.94, 88.94DT, 880, 90/LP	24905360	
LUK410002500	Cuscinetto volano 47 x 17 x 14 mm - Bearing 47 x 17 x 14 mm		35-66,35-66DT,45-66,45-66DT, 446,446DT,466,466DT,480,480DT, 50-66,50-66DT,50-66S,55-66, 50-86,50-86V,50-86VDT,60-86F, 500,500DT,540,540DT,540S,550, 55-46,55-46DT,65-46,65-46DT, 55-66DTLP,60-66,60-66DT,65-66, 55-76F,55-76DT,55-76V,55-76VDT, 55-90,55-90DT,60-90,60-90DT, 566,570,580,600,640,666,670, 60-76F,60-76FDT,70-76DT, 60-86FDT,62-86F,70-86V,72-86F, 65-66DT,70-66,70-66DT,70-66F, 65-90,65-90DT,70-90,70-90DT, 680,766,780,880,880-5,980, 70-66LP,70-66V,80-66,80-66DT, 70-76LP,70-76V,80-76DT,80-76F, 70-86VDT,72-86LP,82-86DT, 72-93,72-93DT,82-93,82-93DT, 72-94,72-94DT,82-94,82-94DT, 80-88,80-88DT,100-90,100-90DT, 80-90,80-90DT,85-90,85-90DT, 82-86F,82-86LP,70-88,70-88DT, 840, 850, 88-93,88-93DT,65-94,65-94DT, 88-94,88-94DT,A100SDT,A110, 90-90,90-90DT,65-93,65-93DT, 980DT,L60,L65,L75,L85,L95, A110SDT,A90SDT	28043280	





**KIT FRIZIONE LUK ORIGINALE RIF. MECCANISMO 5164573 - 5160435**

KIT EMBRAYAGE LUK ORIGINAL REF. 5164573 - 5160435

KIT CLUTCH ORIGINAL LUK REF. 5164573 - 5160435

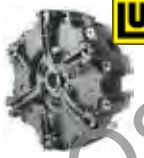
KIT KUPPLUNG LUK REF. 5164573 - 5160435

KIT EMBRAGUE LUK ORIGINAL REF. 5164573 - 5160435

Art./Ref.	Note/Note	Brand	Applicazione/Application	Rif. Orig./Orig. Ref.	Immagine/Image
<b>07867</b>	Meccanismo Frizione 13" - Luk originale	<b>FIAT</b>	1000 DT, 1000 SUPER, 570N/DT, 670N/DT	5160435, 5164573	
<b>07869</b>	Disco Pto Diametro 330 mm Luk originale - Pto Disc Diameter 330 mm Original Luk		1000, 1000 DT, 1000 SUPER, 1000DT, 570N/DT, 670N/DT, 850, 850 DT	5164569, 9924689	
<b>12846</b>	Cuscinetto reggispinta 97 x 65 x 19 mm / Thrust Bearing 97 x 65 x 19 mm		1000, 1000DT, 115-90, 115-90DT, 1180, 1180DT, 1580, 1580DT, 1880, 1880DT, 160-90, 160-90DT,, 180-90, 180-90DT, 570N/DT, 670N/DT	5120853	
<b>LUK500005810</b>	Cuscinetto pto 140 x 106 x 21 mm / Pto Bearing 140 x 106 x 21 mm		1000 DT, 1000 SUPER, 115.90, 115.90DT, 1180, 1180DT, 570N/DT, 670N/DT	44016827	
<b>LUK410002600</b>	Cuscinetto volano 47 x 20 x 14 mm - Bearing 47 x 20 x 14 mm		1000 DT, 1000 SUPER, 115-90, 15-90DT, 130-90, 130-90DT, 1180, 1180DT, 1280, 1280DT., 1380, 1380DT, 1580, 1580DT,, 140-90, 140-90DT, 160-90, 160-90DT, 180-90, 180-90DT, 1880, 1880DT., 570N/DT, 670N/DT, A140, A140DT	28042740	



**KIT FRIZIONE LUK ORIGINALE RIF. MECCANISMO 5177618**

KIT EMBRAYAGE LUK ORIGINAL REF. 5177618

KIT CLUTCH ORIGINAL LUK REF. 5177618

KIT KUPPLUNG LUK REF. 5177618

KIT EMBRAGUE LUK ORIGINAL REF. 5177618

Art./Ref.	Note/Note	Brand	Applicazione/Application	Rif. Orig./Orig. Ref.	Immagine/Image
<b>07877</b>	Meccanismo Frizione 13" - Luk originale	<b>FIAT</b>	F100 - F100DT, F110 - F110DT, F115 - F115DT, F120 - F120DT	5154418	
<b>07878</b>	Disco avanzamento 330 mm a 5 pale Luk originale - Clutch Disc Diameter 330 mm 5 pairs of pads Original Luk		F100 - F100DT, F110 - F110DT, F115 - F115DT, F120 - F120DT	5154419, 5165650	
<b>LUK500085130</b>	Cuscinetto reggispinta completo 115 x 65 x 30 mm / Bearing + carrier assy 115 x 65 x 30 mm		F100 - F100DT, F110 - F110DT, F115 - F115DT, F120 - F120DT, F130 - F130DT, F140 - F140DT	5149611, 9967339	



**KIT FRIZIONE LUK ORIGINALE RIF. 5140361**

KIT EMBRAYAGE LUK ORIGINAL REF. 5140361  
 KIT CLUTCH ORIGINAL LUK REF. 5140361  
 KIT KUPPLUNG LUK REF. 5140361  
 KIT EMBRAGUE LUK ORIGINAL REF. 5140361

Art./Ref.	Note/Note	Brand	Applicazione/Application	Rif. Orig./Orig. Ref.	Immagine/Image
07875	Kit frizione con meccanismo a 6 leve 12" e disco diametro 310 mm - Luk originale	FIAT	1580, 1580DT, 160-90DT, 160.90, 180-90DT, 180.90, 1880, 1880DT	5126010, 5128009, 5128010, 5140361	

**KIT FRIZIONI VALEO**

KIT D'EMBRAYAGE VALEO  
 CLUTCH KIT VALEO  
 KUPPLUNGSSATZ VALEO  
 KIT DE EMBRAGUE VALEO



Art./Ref.	Note/Note	Brand	Applicazione/Application	Rif. Orig./Orig. Ref.
12634	Kit frizione originale Valeo diametro 280 mm / Kit clutch Valeo original diameter 280 mm	FIAT	570, 570 DT, 580, 580 DT, 670, 670 DT, 680, 680 DT, 780, 780 DT	1930987
VALEO19309875	Kit frizione originale Valeo diametro 280 mm / Kit clutch Valeo original diameter 280 mm		550, 550 DT, 600, 600 DT, 640, 640 DT	19309875
12635	Kit frizione originale Valeo diametro 310 mm / Kit clutch Valeo original diameter 310 mm		100.90, 100.90 DT, 110.90, 110.90 DT, 880, 880 DT, 980, 980 DT	1930988
12636	Kit frizione originale Valeo diametro 310 mm / Kit clutch Valeo original diameter 310 mm		115-90 PTO MECCANICA, 115-90DT PTO MECCANICA, 1180, 1180DT, 1280, 1280DT, 1380, 1380DT	1930989
12637	Kit frizione originale Valeo diametro 310 mm / Kit clutch Valeo original diameter 310 mm		1000, 1000 DT SUPER, 850, 850 DT	1930990
12829	Frizione multidisco pto 5" 1/2 PTO - Clutch multi-disc pto 5" 1/2 PTO		115.90 - 115.90DT, 130.90 - 130.90DT, 140.90 - 140.90DT, 160.90 - 160.90DT, 180.90 - 180.90DT, <b>8430 - 8630 - 8830 TRAT. FORD</b>	5141934, 5141934

**KIT FRIZIONE ADATTABILE RIF. 9973691 FORD**



KIT EMBRAYAGE ADAPTABLE REF. 9973691 FORD

KIT CLUTCH ADAPTABLE REF. 9973691 FORD

KIT KUPPLUNG PASSEND ZU REF. 9973691 FORD

KIT EMBRAGUE ADAPTABLE REF. 9973691 FORD

Art./Ref.	Note/Note	Brand	Applicazione/Application	Rif. Orig./Orig. Ref.	Immagine/Image
<b>57940</b>	Kit composto da - Kit consists of: - Meccanismo/Clutch Ref. 5162900 With box Original CNH - Disco Pto/Disc Pto Ref. 5154703 Not Original - Cuscinetto/Bearing Ref. 5122028 Not Original - Cuscinetto/Bearing Ref. 24905360 Not Original	<b>FORD</b>	4030, 4230, 4430	9973691	   
<b>NH5162900</b>	Meccanismo Frizione 11" - Fiat originale		4030, 4230, 4430	47512400, 5162900	
<b>26988</b>	Disco Pto Diametro 280 mm - Pto Disc Diameter 280 mm		4030,4230,4430	5145715, 5154703	
<b>12841</b>	Cuscinetto reggispinta 90 x 50 x 21,60 mm / Thrust Bearing 90 x 50 x 21,60 mm		4635,4835,5635,7635	5122028	
<b>14882</b>	Cuscinetto pto 110 x 70 x 20 mm / Pto Bearing 110 x 70 x 20 mm		3010S-4010S-5010S, 4030,4230,4430	24905360	
<b>84025</b>	Kit composto da - Kit consists of: - Meccanismo/Clutch Ref. 5162900 With box Original LUK - Disco Pto/Disc Pto Ref. 5154703 Not Original - Cuscinetto/Bearing Ref. 5122028 Not Original - Cuscinetto/Bearing Ref. 24905360 Not Original	<b>FORD</b>	4030, 4230, 4430	9973691	   
<b>07859</b>	Meccanismo Frizione 11" - Luk originale		4030, 4230, 4430	47512400, 5162900	

Art./Ref.	Note/Note	Brand	Applicazione/Application	Rif. Orig./Orig. Ref.	Immagine/Image
26988	Disco Pto Diametro 280 mm - Pto Disc Diameter 280 mm	FORD	4030,4230,4430	5145715, 5154703	
12841	Cuscinetto reggispinta 90 x 50 x 21,60 mm / Thrust Bearing 90 x 50 x 21,60 mm		4635,4835,5635,7635	5122028	
14882	Cuscinetto pto 110 x 70 x 20 mm / Pto Bearing 110 x 70 x 20 mm		3010S-4010S-5010S, 4030,4230,4430	24905360	

Art./Ref.	Note/Note	Brand	Applicazione/Application	Rif. Orig./Orig. Ref.	Immagine/Image
LUK628105310	Kit tutto originale LUK composto da - Kit all LUK original consists of: - Meccanismo/Clutch Ref. 228 0098 10 - Disco Pto/Disc Pto 328 0186 16 - Cuscinetto/Bearing Ref. 500 0459 00 - Cuscinetto/Bearing Ref. 500 0284 00 - Cuscinetto/Bearing Ref. 410 0025 00	FORD	4030, 4230, 4430	9973691	    
07859	Meccanismo Frizione 11" - Luk originale		4030, 4230, 4430	47512400, 5162900	
07852	Disco Pto Diametro 280 mm Luk originale - Pto Disc Diameter 280 mm Original Luk		4030,4230,4430	5145715, 5154703	
LUK500045900	Cuscinetto reggispinta 90 x 50 x 21,60 mm / Thrust Bearing 90 x 50 x 21,60 mm		4635,4835,5635,7635	5122028	
LUK500028400	Cuscinetto pto 110 x 70 x 20 mm / Pto Bearing 110 x 70 x 20 mm		3010S-4010S-5010S, 4030,4230,4430	24905360	
LUK410002500	Cuscinetto volano 47 x 17 x 14 mm - Bearing 47 x 17 x 14 mm		4635,4835,5635,7635	28043280	







**MECCANISMO + DISCO PTO ORIGINALE LUK RIF. 625141909**

MECANISME + DISQUE PTO ORIGINAL LUK 625141909

COVER ASSEMBLY + ORIGINAL PTO DISC LUK REF. 625141909

GETRIEBE + ZAPFWELLENSCHEIBE LUK 625141909

MECANISMO + DISCO PTO ORIGINAL LUK REF. 625141909

Art./Ref.	Note/Note	Brand	Applicazione/Application	Rif. Orig./Orig. Ref.	Immagine/Image
<b>LUK625141909</b>	Kit tutto originale LUK composto da - Kit all LUK original consists of: - Meccanismo/Clutch Ref. 225 0049 12 - Disco Pto/Disc Pto 325 0118 16	<b>FORD</b>	3435 - 3935, 3830	5128074, 5139339, 5154513, 5154799, 5171493	 
<b>26858</b>	Meccanismo Frizione 10" - Luk Originale		3435 - 3935, 3830	5139339, 5154513, 5171493	
<b>27384</b>	Disco Pto Diametro 250 mm Luk originale - Pto Disc Diameter 250 mm Original Luk		3435, 3830, 3935	5128074, 5154799	
<b>LUK500045900</b>	Cuscinetto reggispinta 90 x 50 x 21,60 mm / Thrust Bearing 90 x 50 x 21,60 mm		3435 - 3935, 3830, 4135, 4635,4835,5635,7635	5122028	
<b>LUK500067300</b>	Cuscinetto pto 100 x 65 x 18 mm / Pto Bearing 100 x 65 x 18 mm		3435 - 3935, 3830, 4135	24905350	
<b>LUK410002500</b>	Cuscinetto volano 47 x 17 x 14 mm - Bearing 47 x 17 x 14 mm	3435 - 3935, 3830, 4135, 4635,4835,5635,7635	28043280		





**MECCANISMO + DISCO AVANZAMENTO ORIGINALE LUK RIF. 635068609**

MECANISME + DISQUE AVANCEMENT ORIGINAL LUK 635068609

COVER ASSEMBLY + ORIGINAL MAIN DRIVE LUK REF. 635068609

GETRIEBE + VORSCHLEIBE LUK 635068609

MECANISMO + DISCO DE AVANCE ORIGINAL LUK REF. 635068609

Art./Ref.	Note/Note	Brand	Applicazione/Application	Rif. Orig./Orig. Ref.	Immagine/Image
<b>LUK635068609</b>	Kit tutto originale LUK composto da - Kit all LUK original consists of: - Meccanismo/Clutch Ref. 135 0215 10 - Disco Avanzamento/Clutch Disc 335 0129 10	<b>FORD</b>	8160 - 8260 - 8360	5150079, 5165648, 5177620	 
<b>16915</b>	Meccanismo Frizione 14" - Luk originale		8160 - 8260 - 8360	5150079, 5177620	
<b>07880</b>	Disco avanzamento 350 mm a 6 pale Luk originale - Clutch Disc Diameter 350 mm 6 pairs of pads Original Luk		8160 - 8260 - 8360	5165648	
<b>LUK500085130</b>	Cuscinetto reggispinta completo 115 x 65 x 30 mm / Bearing + carrier assy 115 x 65 x 30 mm		8160 - 8260 - 8360	5149611, 9967339	







**MECCANISMO + DISCO AVANZAMENTO ORIGINALE LUK RIF. 635114309**

MECANISME + DISQUE AVANCEMENT ORIGINAL LUK 635114309

COVER ASSEMBLY + ORIGINAL MAIN DRIVE LUK REF. 635114309

GETRIEBE + VORSCHLEIBE LUK 635114309

MECANISMO + DISCO DE AVANCE ORIGINAL LUK REF. 635114309

Art./Ref.	Note/Note	Brand	Applicazione/Application	Rif. Orig./Orig. Ref.	Immagine/Image
<b>LUK635114309</b>	Kit tutto originale LUK composto da - Kit all LUK original consists of: - Meccanismo/Clutch Ref. 135 0215 10 - Disco Avanzamento/Clutch Disc 335 0006 10	<b>FORD</b>	8430 - 8630 - 8830	5118453, 5123062	   
<b>07873</b>	Meccanismo Frizione 14" - Luk originale		8430 - 8630 - 8830	5123062	
<b>07874</b>	Disco avanzamento 350 mm a 8 pale Luk originale - Clutch Disc Diameter 350 mm 8 pairs of pads Original Luk		8430 - 8630 - 8830	5118453	











**KIT FRIZIONE LUK ADATTABILE RIF. 87689658 FORD**

KIT EMBRAYAGE LUK ADAPTABLE REF. 87689658 FORD

KIT CLUTCH LUK ADAPTABLE REF. 87689658 FORD

KIT KUPPLUNG LUK PASSEND ZU REF. 87689658 FORD

KIT EMBRAGUE LUK ADAPTABLE REF. 87689658 FORD

Art./Ref.	Note/Note	Brand	Applicazione/Application	Rif. Orig./Orig. Ref.	Immagine/Image
<b>LUK628105210</b>	Kit tutto originale LUK composto da - Kit all LUK original consists of: - Meccanismo/Clutch Ref. 228 0093 11 - Disco Pto/Disc Pto 328 0253 10 - Cuscinetto/Bearing Ref. 500 0459 00 - Cuscinetto/Bearing Ref. 500 0673 00 - Cuscinetto/Bearing Ref. 410 0025 00	<b>FORD</b>	4135	87689658	    
<b>LUK628105209</b>	Kit tutto originale LUK composto da - Kit all LUK original consists of: - Meccanismo/Clutch Ref. 228 0093 11 - Disco Pto/Disc Pto 328 0253 10		4135	44909044, 47512407, 5171494	 
<b>LUK500045900</b>	Cuscinetto reggispira 90 x 50 x 21,60 mm / Thrust Bearing 90 x 50 x 21,60 mm		3435 - 3935, 3830, 4135, 4635, 4835, 5635, 7635, 6635	5122028	
<b>LUK500067300</b>	Cuscinetto pto 100 x 65 x 18 mm / Pto Bearing 100 x 65 x 18 mm		3435 - 3935, 3830, 4135	24905350	
<b>LUK410002500</b>	Cuscinetto volano 47 x 17 x 14 mm - Bearing 47 x 17 x 14 mm		3435 - 3935, 3830, 4135, 4635, 4835, 5635, 7635, 6635	28043280	

**KIT FRIZIONE LUK ADATTABILE RIF. 87689657 FORD**

KIT EMBRAYAGE LUK ADAPTABLE REF. 87689657 FORD

KIT CLUTCH LUK ADAPTABLE REF. 87689657 FORD

KIT KUPPLUNG LUK PASSEND ZU REF. 87689657 FORD

KIT EMBRAGUE LUK ADAPTABLE REF. 87689657 FORD

Art./Ref.	Note/Note	Brand	Applicazione/Application	Rif. Orig./Orig. Ref.	Immagine/Image
<b>LUK628103410</b>	Kit tutto originale LUK composto da - Kit all LUK original consists of: - Meccanismo/Clutch Ref. 228 0077 17 - Disco Pto/Disc Pto 328 0186 16 - Cuscinetto/Bearing Ref. 500 0459 00 - Cuscinetto/Bearing Ref. 500 0284 00 - Cuscinetto/Bearing Ref. 410 0025 00	<b>FORD</b>	4030-4230-4430	87689657	    
<b>07850</b>	Meccanismo Frizione 11" - Luk originale		4030-4230-4430	47512408, 5154879, 5171137	
<b>07852</b>	Disco Pto Diametro 280 mm Luk originale - Pto Disc Diameter 280 mm Original Luk		4030,4230,4430	5145715, 5154703	
<b>LUK500045900</b>	Cuscinetto reggispinta 90 x 50 x 21,60 mm / Thrust Bearing 90 x 50 x 21,60 mm		3435 - 3935, 3830, 4135, 4635,4835,5635,7635, 6635	5122028	
<b>LUK500028400</b>	Cuscinetto pto 110 x 70 x 20 mm / Pto Bearing 110 x 70 x 20 mm		3010S-4010S-5010S, 4030,4230,4430	24905360	
<b>LUK410002500</b>	Cuscinetto volano 47 x 17 x 14 mm - Bearing 47 x 17 x 14 mm		3435 - 3935, 3830, 4135, 4635,4835,5635,7635, 6635	28043280	

**KIT FRIZIONE LUK ADATTABILE RIF. 9973687 FORD**

KIT EMBRAYAGE LUK ADAPTABLE REF. 9973687 FORD

KIT CLUTCH LUK ADAPTABLE REF. 9973687 FORD

KIT KUPPLUNG LUK PASSEND ZU REF. 9973687 FORD

KIT EMBRAGUE LUK ADAPTABLE REF. 9973687 FORD

Art./Ref.	Note/Note	Brand	Applicazione/Application	Rif. Orig./Orig. Ref.	Immagine/Image
<b>LUK631306010</b>	<p>Kit tutto originale LUK composto da - Kit all LUK original consists of:</p> <ul style="list-style-type: none"> <li>- Meccanismo/Clutch Ref. 231 0105 10</li> <li>- Disco Pto/Disc Pto 331 0220 10</li> <li>- Cuscinetto/Bearing Ref. 500 0459 00</li> <li>- Cuscinetto/Bearing Ref. 500 1292 10</li> <li>- Cuscinetto/Bearing Ref. 410 0025 00</li> </ul>		5635, 6635, 7635	9973687	    
<b>29420</b>	Meccanismo Frizione 12" - Luk Originale	<b>FORD</b>	5635, 6635, 7635	5167935, 5179850, 5189875, 87716719	
<b>29421</b>	Disco Pto Diametro 310 mm Luk originale - Pto Disc Diameter 310 mm Original Luk		5635, 6635, 7635	5167937	
<b>LUK500045900</b>	Cuscinetto reggispinta 90 x 50 x 21,60 mm / Thrust Bearing 90 x 50 x 21,60 mm		3435 - 3935, 3830, 4135, 4635, 4835, 5635, 7635, 6635	5122028	
<b>LUK500129210</b>	Cuscinetto pto 115 x 75 x 20 mm / Pto Bearing 115 x 75 x 20 mm		4635-4835-5635-7635, 6635	5112084, 5167183	
<b>LUK410002500</b>	Cuscinetto volano 47 x 17 x 14 mm - Bearing 47 x 17 x 14 mm		3435 - 3935, 3830, 4135, 4635, 4835, 5635, 7635, 6635	28043200	

**KIT FRIZIONE LUK ORIGINALE RIF. 631200110**

KIT EMBRAYAGE LUK ORIGINAL REF. 631200110

KIT CLUTCH ORIGINAL LUK REF. 631200110

KIT KUPPLUNG LUK REF. 631200110

KIT EMBRAGUE LUK ORIGINAL REF. 631200110

Art./Ref.	Note/Note	Brand	Applicazione/Application	Rif. Orig./Orig. Ref.	Immagine/Image
<b>LUK631200110</b>	Kit tutto originale LUK composto da - Kit all LUK original consists of: - Meccanismo/Clutch Ref. 231 0089 10 - Disco Pto/Disc Pto 331 0220 10 - Cuscinetto/Bearing Ref. 500 0459 00 - Cuscinetto/Bearing Ref. 500 1292 10 - Cuscinetto/Bearing Ref. 410 0025 00	<b>FORD</b>	4835, 5635	87689674	    
<b>29422</b>	Meccanismo Frizione 12" - Luk Originale		4835, 5635	5167933	
<b>29421</b>	Disco Pto Diametro 310 mm Luk originale - Pto Disc Diameter 310 mm Original Luk		4835, 5635, 6635, 7635	5167937	
<b>LUK500045900</b>	Cuscinetto reggispinta 90 x 50 x 21,60 mm / Thrust Bearing 90 x 50 x 21,60 mm		3435 - 3935, 3830, 4135, 4635, 4835, 5635, 7635, 6635	5122028	
<b>LUK500129210</b>	Cuscinetto pto 115 x 75 x 20 mm / Pto Bearing 115 x 75 x 20 mm		4635-4835-5635-7635, 6635	5112084, 5167183	
<b>LUK410002500</b>	Cuscinetto volano 47 x 17 x 14 mm - Bearing 47 x 17 x 14 mm		3435 - 3935, 3830, 4135, 4635, 4835, 5635, 7635, 6635	28043280	





**KIT FRIZIONE LUK ORIGINALE RIF. 131024910+331021910+500124010**

KIT EMBRAYAGE LUK ORIGINAL REF. 131024910+331021910+500124010

KIT CLUTCH ORIGINAL LUK REF. 131024910+331021910+500124010

KIT KUPPLUNG LUK REF. 131024910+331021910+500124010

KIT EMBRAGUE LUK ORIGINAL REF. 131024910+331021910+500124010

Art./Ref.	Note/Note	Brand	Applicazione/Application	Rif. Orig./Orig. Ref.	Immagine/Image
29418	Meccanismo Frizione 12" - Luk originale	FORD	4635-4835-5635-6635-7635, 6630	5167939, 5189823	
29419	Disco avanzamento 310 mm a 6 pale Luk originale - Clutch Disc Diameter 310 mm 6 pairs of pads Original Luk		4635,4835,5635,6635,7635, 6630	5179851, 5189825	
LUK500124010	Cuscinetto reggispinta completo 110 x 65 x 210 mm / Bearing + carrier assy 110 x 65 x 210 mm		4635-4835-5635-6635-7635, 6630	5166287	



**KIT FRIZIONE LUK ORIGINALE RIF. MECCANISMO 5177618**

KIT EMBRAYAGE LUK ORIGINAL REF. 5177618

KIT CLUTCH ORIGINAL LUK REF. 5177618

KIT KUPPLUNG LUK REF. 5177618

KIT EMBRAGUE LUK ORIGINAL REF. 5177618

Art./Ref.	Note/Note	Brand	Applicazione/Application	Rif. Orig./Orig. Ref.	Immagine/Image
07877	Meccanismo Frizione 13" - Luk originale	FORD	8160 - 8260 - 8360	5177618	
07878	Disco avanzamento 330 mm a 5 pale Luk originale - Clutch Disc Diameter 330 mm 5 pairs of pads Original Luk		8160 - 8260 - 8360	5165650	
LUK500085130	Cuscinetto reggispinta completo 115 x 65 x 30 mm / Bearing + carrier assy 115 x 65 x 30 mm		8160 - 8260 - 8360	5149611, 9967339	

**KIT FRIZIONE LUK ADATTABILE RIF. 87689675 NEW HOLLAND**

KIT EMBRAYAGE LUK ADAPTABLE REF. 87689675 NEW HOLLAND

KIT CLUTCH LUK ADAPTABLE REF. 87689675 NEW HOLLAND

KIT KUPPLUNG LUK PASSEND ZU REF. 87689675 NEW HOLLAND

KIT EMBRAGUE LUK ADAPTABLE REF. 87689675 NEW HOLLAND

Art./Ref.	Note/Note	Brand	Applicazione/Application	Rif. Orig./Orig. Ref.	Immagine/Image
<b>LUK628308610</b>	Kit tutto originale LUK composto da - Kit all LUK original consists of: - Meccanismo/Clutch Ref. 228 0184 10 - Disco Pto/Disc Pto 328 0332 10 - Cuscinetto/Bearing Ref. 500 0459 00 - Cuscinetto/Bearing Ref. 500 1292 10 - Cuscinetto/Bearing Ref. 410 0025 00		T4040, TN85A - TN85DA - TN85SA, TN95A - TN95DA, TN95NA - TN95VA	87689675	
<b>29416</b>	Meccanismo Frizione 11" - Luk originale	<b>NEW HOLLAND</b>	T4020 - T4020V, T4030 - T4030F, T4030N - T4040, T4030N - T4030V, T4040, T4040 - T4040F, T4040N - T4040V, T4050F - T4050N - T4050V, TN65F, TN70F - TN70NA, TN75F, TN75F - TN75FA, TN80F, TN85A - TN85DA, TN85A - TN95A, TN85DA - TN95DA, TN85FA - TN85SA, TN85FA - TN95FA, TN85SA, TN90F, TN95A - TN95DA, TN95F, TN95FA, TN95NA, TN95NA - TN95VA, TN95VA	5181421, 5196813, 87732504, 87732506	
<b>29414</b>	Disco Pto Diametro 280 mm Luk originale - Pto Disc Diameter 280 mm Original Luk		T4020 - T4020V, T4030 - T4030F, T4030N - T4030V, T4040, T4040 - T4040F, T4040N - T4040V, T4050F - T4050N - T4050V, TN65F, TN70F - TN70NA, TN75F, TN75F - TN75FA, TN80F, TN85A - TN85DA, TN85FA - TN85SA, TN90F, TN95A - TN95DA, TN95F, TN95FA, TN95NA - TN95VA	47134874, 5176450	
<b>LUK500045900</b>	Cuscinetto reggispinta 90 x 50 x 21,60 mm / Thrust Bearing 90 x 50 x 21,60 mm		TL100, TL80, TL90, TL70A, TL80A, TL90A, TN55, TN65, TN70D, TN60A, TN55S, TN65S, TN70S, TN75S, TN60SA, TN60VA, TN70VA, TN75VA, TN95VA, TN70A, TN75A, TN55D, TN65D, TN60DA, TN70DA, TN75DA, TN70F, TN75F, TN70SA, TN75SA, TN55V, TN65V, TN75V, TN55V, TN65V, TN75V, TN80F, TN95F, TN75FA, TN85FA, TN95FA, TN65N, TN75N, TN70NA	5122028, 82824591, 82824592, 87289219, 87345759, 87541562, 9976506	
<b>LUK500129210</b>	Cuscinetto pto 115 x 75 x 20 mm / Pto Bearing 115 x 75 x 20 mm		L60-L65-L75-L85-L95, T5050 - T5060, TL70A-TL80A-TL90A, TL80 - TL90, TN55D-TN65D-TN70D, TN55S-TN65S-TN70S-TN75S, TN55V-TN65V-TN75V, TN60A-TN70A-TN75A, TN60DA-TN70DA-TN75DA, TN60SA-TN70SA-TN75SA, TN60VA-TN70VA-TN75VA-TN95VA, TN65N-TN75N, TN70F-TN75F-TN80F-TN95F, TN70NA, TN75FA-TN85FA-TN95FA	5112084, 5167183	
<b>LUK410002500</b>	Cuscinetto volano 47 x 17 x 14 mm - Bearing 47 x 17 x 14 mm		T4020 - T4020V, T4030 - T4030F, T4030N - T4030V, T4040, T4040 - T4040F, T4040N - T4040V, T4050F - T4050N - T4050V, TN65F, TN70F - TN70NA, TN75F - TN75FA, TN80F, TN85A - TN85DA, TN85FA - TN85SA, TN90F, TN95A - TN95DA, TN95F, TN95FA, TN95NA - TN95VA	28043280	

**KIT FRIZIONE LUK ADATTABILE RIF. 87689657 NEW HOLLAND**

KIT EMBRAYAGE LUK ADAPTABLE REF. 87689657 NEW HOLLAND

KIT CLUTCH LUK ADAPTABLE REF. 87689657 NEW HOLLAND

KIT KUPPLUNG LUK PASSEND ZU REF. 87689657 NEW HOLLAND

KIT EMBRAGUE LUK ADAPTABLE REF. 87689657 NEW HOLLAND

Art./Ref.	Note/Note	Brand	Applicazione/Application	Rif. Orig./Orig. Ref.	Immagine/Image
<b>LUK628103410</b>	Kit tutto originale LUK composto da - Kit all LUK original consists of: - Meccanismo/Clutch Ref. 228 0077 17 - Disco Pto/Disc Pto 328 0186 16 - Cuscinetto/Bearing Ref. 500 0459 00 - Cuscinetto/Bearing Ref. 500 0284 00 - Cuscinetto/Bearing Ref. 410 0025 00	<b>NEW HOLLAND</b>	TD 55 D, TD 60 D, TD 60 STRADDLE MOUNT, TD 65 B - D, TD 70 D, TD 70 STRADDLE MOUNT, TD 75 D, TD 80 D, TD 80 STRADDLE MOUNT, TD 85 D, TD 90 D, TD 90 STRADDLE MOUNT, TT 65 D	87689657	    
<b>07850</b>	Meccanismo Frizione 11" - Luk originale		TD 55 D, TD 60 D, TD 60 STRADDLE MOUNT, TD 65 B - D, TD 70 D, TD 70 STRADDLE MOUNT, TD 75 D, TD 80 D, TD 80 STRADDLE MOUNT, TD 85 D, TD 90 D, TD 90 STRADDLE MOUNT, TT 65 D	47512408, 5154879, 5171137	
<b>07852</b>	Disco Pto Diametro 280 mm Luk originale - Pto Disc Diameter 280 mm Original Luk		TD 55 D, TD 60 D, TD 60 STRADDLE MOUNT, TD 65 B - D, TD 70 D, TD 70 STRADDLE MOUNT, TD 75 D, TD 80 D, TD 80 STRADDLE MOUNT, TD 85 D, TD 90 D, TD 90 STRADDLE MOUNT, TD4020F - TD4030F - TD4040F, TD5.75 - TD5.80, TD5.85 - TD5.90, TD5010 - TD5020 - TD5030, TD85D, TD90D, TK4030, TK80.66 DT, TT 65 D	5145715, 5154703	
<b>LUK500045900</b>	Cuscinetto reggispinta 90 x 50 x 21,60 mm / Thrust Bearing 90 x 50 x 21,60 mm		TL 100, TL80, TL90, TL70A, TL80A, TL90A, TN55, TN65, TN70D, TN60A, TN55S, TN65S, TN70S, TN75S, TN60SA, TN60VA, TN70VA, TN75VA, TN95VA, TN70A, TN75A, TN55D, TN65D, TN60DA, TN70DA, TN75DA, TN70F, TN75F, TN70SA, TN75SA, TN55V, TN65V, TN75V, TN55V, TN65V, TN75V, TN80F, TN95F, TN75FA, TN85FA, TN95FA, TN65N, TN75N, TN70NA	5122028, 82824591, 82824592, 87289219, 87345759, 87541562, 9976506	
<b>LUK500028400</b>	Cuscinetto pto 110 x 70 x 20 mm / Pto Bearing 110 x 70 x 20 mm		T7030-T7040-T7050-T7060-T7070, TD4020F-TD4030F-TD4040F, TD5.100-TD5.105, TD5.110-TD5.115, TD5.65-TD5.75-TD5.80, TD5.85-TD5.90-TD5.95, TD5010-TD5020-TD5030, TD5040-TD5050, TD60-TD70-TD80-TD90-TD95, TD60D-TD70D-TD80D-TD90D-TD95D, TD65B, TD65F-TD75F-TD85F, TD85D, TD90D, TK4030, TK80.66DT, TT50-TT55-TT65-TT65D-TT75	24905360	
<b>LUK410002500</b>	Cuscinetto volano 47 x 17 x 14 mm - Bearing 47 x 17 x 14 mm		L65 - L75 - L85 - L95, T4.75 - T4.85, T4.95 - T4.105, T4020 - T4020V, T4030 - T4030F, T4030N - T4030V, T4040, T4040 - T4040F, T4040N - T4040V, T4050F - T4050N - T4050V, T5030 - T5040, T5050 - T5060, TD 55 D, TD 60 D, TD 60 STRADDLE MOUNT, TD 65 B - D, TD 70 D, TD 70 STRADDLE MOUNT, TD 75 D, TD 80 D, TD 80 STRADDLE MOUNT, TD 85 D, TD 90 D, TD 90 STRADDLE MOUNT, TD5040 - TD5050, TL70 - TL75, TL70A - TL80A - TL90A - TL100A, TL75E - TL85E - TL95E, TL80 - TL85, TL90 - TL95 - TL100, TN65F, TN70F - TN70NA, TN75F - TN75FA, TN80F, TN85A - TN85DA, TN85FA - TN85SA, TN90F, TN95A - TN95DA, TN95F, TN95FA, TN95NA - TN95VA, TT 65 D	28043280	





**KIT FRIZIONE LUK ADATTABILE RIF. 9973687 NEW HOLLAND**

KIT EMBRAYAGE LUK ADAPTABLE REF. 9973687 NEW HOLLAND

KIT CLUTCH LUK ADAPTABLE REF. 9973687 NEW HOLLAND

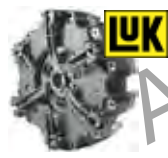
KIT KUPPLUNG LUK PASSEND ZU REF. 9973687 NEW HOLLAND

KIT EMBRAGUE LUK ADAPTABLE REF. 9973687 NEW HOLLAND

Art./Ref.	Note/Note	Brand	Applicazione/Application	Rif. Orig./Orig. Ref.	Immagine/Image
<b>LUK631306010</b>	Kit tutto originale LUK composto da - Kit all LUK original consists of: - Meccanismo/Clutch Ref. 231 0105 10 - Disco Pto/Disc Pto 331 0220 10 - Cuscinetto/Bearing Ref. 500 0459 00 - Cuscinetto/Bearing Ref. 500 1292 10 - Cuscinetto/Bearing Ref. 410 0025 00		L65 - L75 - L85 - L95, T4.75 - T4.85, T4.95 - T4.105, T5030 - T5040, T5050 - T5060, TD5040 - TD5050, TL70 - TL75, TL70A - TL80A - TL90A - TL100A, TL75E - TL85E - TL95E, TL80 - TL85, TL90 - TL95 - TL100	9973687	
<b>29420</b>	Meccanismo Frizione 12" - Luk Originale		L65 - L75 - L85 - L95, T4.75 - T4.85, T4.95 - T4.105, T5030 - T5040, T5050 - T5060, TD5040 - TD5050, TL70 - TL75, TL70A - TL80A - TL90A - TL100A, TL75E - TL85E - TL95E, TL80 - TL85, TL90 - TL95 - TL100	5167935, 5179850, 5189875, 87716719	
<b>29421</b>	Disco Pto Diametro 310 mm Luk originale - Pto Disc Diameter 310 mm Original Luk	<b>NEW HOLLAND</b>	L65 - L75 - L85 - L95, T4.75 - T4.85, T4.95 - T4.105, T5030 - T5040, T5050 - T5060, TD5040 - TD5050, TL70 - TL75, TL70A - TL80A - TL90A - TL100A, TL75E - TL85E - TL95E, TL80 - TL85, TL90 - TL95 - TL100	5167937	
<b>LUK500045900</b>	Cuscinetto reggispira 90 x 50 x 21,60 mm / Thrust Bearing 90 x 50 x 21,60 mm		TL100, TL80, TL90, TL70A, TL80A, TL90A, TN55, TN65, TN70D, TN60A, TN55S, TN65S, TN70S, TN75S, TN60SA, TN60VA, TN70VA, TN75VA, TN95VA, TN70, TN75A, TN55D, TN65D, TN60DA, TN70DA, TN75DA, TN70F, TN75F, TN70SA, TN75SA, TN55V, TN65V, TL75V, TN55V, TN65V, TN75V, TN80F, TN95F, TN75FA, TN85FA, TN95FA, TN65N, TN75N, TN70NA	5122028, 82824591, 82824592, 87289219, 87345759, 87541562, 9976506	
<b>LUK500129210</b>	Cuscinetto pto 115 x 75 x 20 mm / Pto Bearing 115 x 75 x 20 mm		L60-L65-L75-L85-L95, T5050 - T5060, TL70A-TL80A-TL90A, TL80 - TL90, TN55D-TN65D-TN70D, TN55S-TN65S-TN70S-TN75S, TN55V-TN65V-TN75V, TN60A-TN70A-TN75A, TN60DA-TN70DA-TN75DA, TN60SA-TN70SA-TN75SA, TN60VA-TN70VA-TN75VA-TN95VA, TN65N-TN75N, TN70F-TN75F-TN80F-TN95F, TN70NA, TN75FA-TN85FA-TN95FA	5112084, 5167183	
<b>LUK410002500</b>	Cuscinetto volano 47 x 17 x 14 mm - Bearing 47 x 17 x 14 mm		L65 - L75 - L85 - L95, T4.75 - T4.85, T4.95 - T4.105, T4020 - T4020V, T4030 - T4030F, T4030N - T4030V, T4040, T4040 - T4040F, T4040N - T4040V, T4050F - T4050N - T4050V, T5030 - T5040, T5050 - T5060, TD 55 D, TD 60 D, TD 60 STRADDLE MOUNT, TD 65 B - D, TD 70 D, TD 70 STRADDLE MOUNT, TD 75 D, TD 80 D, TD 80 STRADDLE MOUNT, TD 85 D, TD 90 D, TD 90 STRADDLE MOUNT, TD5040 - TD5050, TL70 - TL75, TL70A - TL80A - TL90A - TL100A, TL75E - TL85E - TL95E, TL80 - TL85, TL90 - TL95 - TL100, TN65F, TN70F - TN70NA, TN75E - TN75FA, TN80F, TN85A - TN85DA, TN85FA - TN85SA, TN90F, TN95A - TN95DA, TN95F, TN95FA, TN95NA - TN95VA, TT 65 D	28043280	

**KIT FRIZIONE LUK ADATTABILE RIF. 73328271 NEW HOLLAND**

KIT EMBRAYAGE LUK ADAPTABLE REF. 73328271 NEW HOLLAND

KIT CLUTCH LUK ADAPTABLE REF. 73328271 NEW HOLLAND

KIT KUPPLUNG LUK PASSEND ZU REF. 73328271 NEW HOLLAND

KIT EMBRAGUE LUK ADAPTABLE REF. 73328271 NEW HOLLAND

Art./Ref.	Note/Note	Brand	Applicazione/Application	Rif. Orig./Orig. Ref.	Immagine/Image
<b>LUK628308710</b>	Kit tutto originale LUK composto da - Kit all LUK original consists of: - Meccanismo/Clutch Ref. 228 0136 10 - Disco Pto/Disc Pto 328 0332 10 - Cuscinetto/Bearing Ref. 500 0459 00 - Cuscinetto/Bearing Ref. 500 1292 10 - Cuscinetto/Bearing Ref. 410 0025 00		TN55 - TN65 - TN70 - TN75, TN55V- TN65V - TN75V, TN60A - TN70A - TN75A, TN60VA - TN70VA, TN65N - TN75N, TN70A - TN75A, TN70NA - TN75NA - TN95NA, TN75VA - TN95VA	73328271	
<b>88971</b>	Meccanismo Frizione 11" - Luk Originale		TN55 - TN65 - TN70 - TN75, TN55V- TN65V - TN75V, TN60A - TN70A - TN75A, TN60VA - TN70VA, TN65N - TN75N, TN70A - TN75A, TN70NA - TN75NA - TN95NA, TN75VA - TN95VA	47134898, 5186552, 5196816, 5196818	
<b>29863</b>	Disco Pto Diametro 280 mm Luk originale - Pto Disc Diameter 280 mm Original Luk	<b>NEW HOLLAND</b>	TN55 - TN65 - TN70 - TN75, TN55V- TN65V - TN75V, TN60A - TN70A - TN75A, TN60VA - TN70VA, TN65N - TN75N, TN70A - TN75A, TN70NA - TN75NA - TN95NA, TN75VA - TN95VA	5196819	
<b>LUK500045900</b>	Cuscinetto reggispinta 90 x 50 x 21,60 mm / Thrust Bearing 90 x 50 x 21,60 mm		TD 60 D PLUS, TD 65 F, TD 70 D PLUS, TD 75 F, TD 80 D, TD 80 D PLUS, TD 85 F, TD 90 D, TD 90 D PLUS, TD4020F, TD4030F, TD4040F, TD5.75, TD5.80, TD5.85, TD5.90, TD5010, TD5020, TD5030, TL100, TL80, TL90, TL70A, TL80A, TL90A, TN55, TN65, TN70D, TN60A, TN55S, TN65S, TN70S, TN75S, TN60SA, TN60VA, TN70VA, TN75VA, TN95VA, TN70A, TN75A, TN55D, TN65D, TN60DA, TN70DA, TN75DA, TN70F, TN75F, TN70SA, TN75SA, TN55V, TN65V, TN75V, TN55V, TN65V, TN75V, TN80F, TN95F, TN75FA, TN85FA, TN95FA, TN65N, TN75N, TN70NA	5122028, 82824591, 82824592, 87289219, 87345759, 87541562, 9976506	
<b>LUK500129210</b>	Cuscinetto pto 115 x 75 x 20 mm / Pto Bearing 115 x 75 x 20 mm		L60-L65-L75-L85-L95, T5050 - T5060, TL70A-TL80A-TL90A, TL80 - TL90, TN55D-TN65D-TN70D, TN55S-TN65S-TN70S-TN75S, TN55V-TN65V-TN75V, TN60A-TN70A-TN75A, TN60DA-TN70DA- TN75DA, TN60SA-TN70SA-TN75SA, TN60VA-TN70VA-TN75VA- TN95VA, TN65N-TN75N, TN70F-TN75F-TN80F-TN95F, TN70NA, TN75FA-TN85FA-TN95FA	5112084, 5167183	
<b>LUK410002500</b>	Cuscinetto volano 47 x 17 x 14 mm - Bearing 47 x 17 x 14 mm		L65 - L75 - L85 - L95, T4.75 - T4.85, T4.95 - T4.105, T4020 - T4020V, T4030 - T4030F, T4030N - T4030V, T4040, T4040 - T4040F, T4040N - T4040V, T4050F - T4050N - T4050V, T5030 - T5040, T5050 - T5060, TD 55 D, TD 60 D, TD 60 STRADDLE MOUNT, TD 65 B - D, TD 70 D, TD 70 STRADDLE MOUNT, TD 75 D, TD 80 D, TD 80 STRADDLE MOUNT, TD 85 D, TD 90 D, TD 90 STRADDLE MOUNT, TD4020F, TD4030F, TD4040F, TD5.75, TD5.80, TD5.85, TD5.90, TD5010, TD5020, TD5030, TD5040 - TD5050, TL70 - TL75, TL70A - TL80A - TL90A - TL100A, TL75E - TL85E - TL95E, TL80 - TL85, TL90 - TL95 - TL100, TN65F, TN70F - TN70NA, TN75F - TN75FA, TN80F, TN85A - TN85DA, TN85FA - TN85SA, TN90F, TN95A - TN95DA, TN95F, TN95FA, TN95NA - TN95VA, TT 65 D	28043280	

**KIT FRIZIONE LUK ORIGINALE RIF. 628318112**

KIT EMBRAYAGE LUK ORIGINAL REF. 628318112

KIT CLUTCH ORIGINAL LUK REF. 628318112

KIT KUPPLUNG LUK REF. 628318112

KIT EMBRAGUE LUK ORIGINAL REF. 628318112

Art./Ref.	Note/Note	Brand	Applicazione/Application	Rif. Orig./Orig. Ref.	Immagine/Image
<b>LUK628318112</b>	Kit tutto originale LUK composto da - Kit all LUK original consists of: - Meccanismo/Clutch Ref. 128 0302 10 - Disco Pto/Disc Pto 328 0332 11 - Cuscinetto/Bearing Ref. 500 1292 10 - Cuscinetto/Bearing Ref. 410 0133 10		T4020 - T4020V, T4030 - T4030 F-N-V, T4040 - T4040 F-N-V, T4050 F-N-V, TN55 - TN65 . TN70 - TN75, TN55D - TN60D - TN65D - TN75D, TN55S - TN65S - TN70S - TN75S, TN55V - TN65V - TN75V, TN60A - TN70A - TN75A, TN60DA - TN70DA - TN75DA, TN60SA - TN70SA - TN75SA, TN60VA - TN70VA - TN75VA, TN65F - TN75F - TN90F, TN65N - TN75N, TN70NA - TN75NA, TN80F, TN85A - TN85DA - TN85FA, TN85SA, TN95A - TN95DA, TN95F - TN95FA, TN95NA - TN95VA	47134884, 5186548, 5196770, 87732490	
<b>29865</b>	Meccanismo Frizione 11" - Luk Originale	<b>NEW HOLLAND</b>	T4020 - T4020V, T4030 - T4030 F-N-V, T4040 - T4040 F-N-V, T4050 F-N-V, TN55 - TN65 . TN70 - TN75, TN55D - TN60D - TN65D - TN75D, TN55S - TN65S - TN70S - TN75S, TN55V - TN65V - TN75V, TN60A - TN70A - TN75A, TN60DA - TN70DA - TN75DA, TN60SA - TN70SA - TN75SA, TN60VA - TN70VA - TN75VA, TN65F - TN75F - TN90F, TN65N - TN75N, TN70NA - TN75NA, TN80F, TN85A - TN85DA - TN85FA, TN85SA, TN95A - TN95DA, TN95F - TN95FA, TN95NA - TN95VA	47134884, 5186548, 5196770, 87732490	
<b>29414</b>	Disco Pto Diametro 280 mm Luk originale - Pto Disc Diameter 280 mm Original Luk		T4020 - T4020V, T4030 - T4030F, T4030N - T4030V, T4040, T4040 - T4040F, T4040N - T4040V, T4050F - T4050N - T4050V, TN65F, TN70F - TN70N, TN75F, TN75F - TN75FA, TN80F, TN85A - TN85DA, TN85FA - TN85SA, TN90F - TN95A - TN95DA, TN95F, TN95FA, TN95NA - TN95VA	47134874, 5176450	
<b>LUK500129210</b>	Cuscinetto pto 115 x 75 x 20 mm / Pto Bearing 115 x 75 x 20 mm		L60-L65-L75-L85-L95, T5050 - T5060, TL70A-TL80A-TL90A, TL80 - TL90, TN55D-TN65D-TN70D, TN55S-TN65S-TN70S-TN75S, TN55V-TN65V-TN75V, TN60A-TN70A-TN75A, TN60DA-TN70DA-TN75DA, TN60SA-TN70SA-TN75SA, TN60VA-TN70VA-TN75VA-TN95VA, TN65N-TN75N, TN70F-TN75F-TN80F-TN95F, TN70NA, TN75FA-TN85FA-TN95FA	5112084, 5167183	
<b>LUK410013310</b>	Cuscinetto volano 40 x 17 x 12 mm - Bearing 40 x 17 x 12 mm		T4020 - T4020V, T4030 - T4030 F-N-V, T4040 - T4040 F-N-V, T4050 F-N-V, TN55 - TN65 . TN70 - TN75, TN55D - TN60D - TN65D - TN75D, TN55S - TN65S - TN70S - TN75S, TN55V - TN65V - TN75V, TN60A - TN70A - TN75A, TN60DA - TN70DA - TN75DA, TN60SA - TN70SA - TN75SA, TN60VA - TN70VA - TN75VA, TN65F - TN75F - TN90F, TN65N - TN75N, TN70NA - TN75NA, TN80F, TN85A - TN85DA - TN85FA, TN85SA, TN95A - TN95DA, TN95F - TN95FA, TN95NA - TN95VA	87729147	

**KIT FRIZIONE LUK ORIGINALE RIF. 631200110**

KIT EMBRAYAGE LUK ORIGINAL REF. 631200110

KIT CLUTCH ORIGINAL LUK REF. 631200110

KIT KUPPLUNG LUK REF. 631200110

KIT EMBRAGUE LUK ORIGINAL REF. 631200110

Art./Ref.	Note/Note	Brand	Applicazione/Application	Rif. Orig./Orig. Ref.	Immagine/Image
<b>LUK631200110</b>	Kit tutto originale LUK composto da - Kit all LUK original consists of: - Meccanismo/Clutch Ref. 231 0089 10 - Disco Pto/Disc Pto 331 0220 10 - Cuscinetto/Bearing Ref. 500 0459 00 - Cuscinetto/Bearing Ref. 500 1292 10 - Cuscinetto/Bearing Ref. 410 0025 00		L65 - L75, TL70 - TL80 - TL90 - TL100	87689674	
<b>29422</b>	Meccanismo Frizione 12" - Luk Originale		L65 - L75, TL70 - TL80 - TL90 - TL100	5167933	
<b>29421</b>	Disco Pto Diametro 310 mm Luk originale - Pto Disc Diameter 310 mm Original Luk	<b>NEW HOLLAND</b>	L65 - L75 - L85 - L95, T4.75 - T4.85, T4.95 - T4.105, T5030 - T5040, T5050 - T5060, TD5040 - TD5050, TL70 - TL75, TL70A - TL80A - TL90A - TL100A, TL75E - TL85E - TL95E, TL80 - TL85, TL90 - TL95 - TL100	5167937	
<b>LUK500045900</b>	Cuscinetto reggispinta 90 x 50 x 21,60 mm / Thrust Bearing 90 x 50 x 21,60 mm		TD 60 D PLUS, TD 65 F, TD 70 D PLUS, TD 75 F, TD 80 D, TD 80 D PLUS, TD 85 F, TD 90 D, TD 90 D PLUS, TD4020F, TD4030F, TD4040F, TD5.75, TD5.80, TD5.85, TD5.90, TD5010, TD5020, TD5030, TL100, TL80, TL90, TL70A, TL80A, TL90A, TN55, TN65, TN70D, TN60A, TN55S, TN65S, TN70S, TN75S, TN60SA, TN60VA, TN70VA, TN75VA, TN95VA, TN70A, TN75A, TN55D, TN65D, TN60DA, TN70DA, TN75DA, TN70F, TN75F, TN70SA, TN75SA, TN55V, TN65V, TN75V, TN55V, TN65V, TN75V, TN80F, TN95F, TN75FA, TN85FA, TN95FA, TN65N, TN75N, TN70NA	5122028, 82824591, 82824592, 87289219, 87345759, 87541562, 9976506	
<b>LUK500129210</b>	Cuscinetto pto 115 x 75 x 20 mm / Pto Bearing 115 x 75 x 20 mm		L60-L65-L75-L85-L95, T5050 - T5060, TL70A-TL80A-TL90A, TL80 - TL90, TN55D-TN65D-TN70D, TN55S-TN65S-TN70S-TN75S, TN55V-TN65V-TN75V, TN60A-TN70A-TN75A, TN60DA-TN70DA-TN75DA, TN60SA-TN70SA-TN75SA, TN60VA-TN70VA-TN75VA-TN95VA, TN65N-TN75N, TN70F-TN75F-TN80F-TN95F, TN70NA, TN75FA-TN85FA-TN95FA	5112084, 5167183	
<b>LUK410002500</b>	Cuscinetto volano 47 x 17 x 14 mm - Bearing 47 x 17 x 14 mm		L65 - L75 - L85 - L95, T4.75 - T4.85, T4.95 - T4.105, T4020 - T4020V, T4030 - T4030F, T4030N - T4030V, T4040, T4040 - T4040F, T4040N - T4040V, T4050F - T4050N - T4050V, T5030 - T5040, T5050 - T5060, TD 55 D, TD 60 D, TD 60 STRADDLE MOUNT, TD 65 B - D, TD 70 D, TD 70 STRADDLE MOUNT, TD 75 D, TD 80 D, TD 80 STRADDLE MOUNT, TD 85 D, TD 90 D, TD 90 STRADDLE MOUNT, TD4020F, TD4030F, TD4040F, TD5.75, TD5.80, TD5.85, TD5.90, TD5010, TD5020, TD5030, TD5040 - TD5050, TL70 - TL75, TL70A - TL80A - TL90A - TL100A, TL75E - TL85E - TL95E, TL80 - TL85, TL90 - TL95 - TL100, TN65F, TN70F - TN70NA, TN75F - TN75FA, TN80F, TN85A - TN85DA, TN85FA - TN85SA, TN90F, TN95A - TN95DA, TN95F, TN95FA, TN95NA - TN95VA, TT 65 D	28043280	



**KIT FRIZIONE LUK ORIGINALE RIF. 131024910+331021910+500124010**

KIT EMBRAYAGE LUK ORIGINAL REF. 131024910+331021910+500124010

KIT CLUTCH ORIGINAL LUK REF. 131024910+331021910+500124010

KIT KUPPLUNG LUK REF. 131024910+331021910+500124010

KIT EMBRAGUE LUK ORIGINAL REF. 131024910+331021910+500124010

Art./Ref.	Note/Note	Brand	Applicazione/Application	Rif. Orig./Orig. Ref.	Immagine/Image
<b>29418</b>	Meccanismo Frizione 12" - Luk originale	<b>NEW HOLLAND</b>	L75, L85, L95, T5030-T5040-T5050-T5060, TL100, TL100A, TL70, TL70A, TL80, TL80A, TL90, TL90A	5167939, 5189823	
<b>29419</b>	Disco avanzamento 310 mm a 6 pale Luk originale - Clutch Disc Diameter 310 mm 6 pairs of pads Original Luk		L75, L85, L95, TL100, TL90, TL80, TL70, TL100A, TL70A, TL80A, TL90A	5167936, 5179851, 5189825, 87716700	
<b>LUK500124010</b>	Cuscinetto reggispinta completo 110 x 65 x 210 mm / Bearing + carrier assy 110 x 65 x 210 mm		L75, L85, L95, T5030-T5040-T5050-T5060, TL100, TL100A, TL70, TL70A, TL80, TL80A, TL90, TL90A	5166287	





**KIT FRIZIONE LUK ORIGINALE RIF. MECCANISMO 84177326**

KIT EMBRAYAGE LUK ORIGINAL REF. 84177326

KIT CLUTCH ORIGINAL LUK REF. 84177326

KIT KUPPLUNG LUK REF. 84177326

KIT EMBRAGUE LUK ORIGINAL REF. 84177326

Art./Ref.	Note/Note	Brand	Applicazione/Application	Rif. Orig./Orig. Ref.	Immagine/Image
<b>LUK228018610</b>	Meccanismo Frizione 11" - Luk originale	<b>NEW HOLLAND</b>	TD 60 D PLUS, TD 65 F, TD 70 D PLUS, TD 75 F, TD 80 D, TD 80 D PLUS, TD 85 F, TD 90 D, TD 90 D PLUS, TD4020F, TD4030F, TD4040F, TD5.75, TD5.80, TD5.85, TD5.90, TD5010, TD5020, TD5030	84177326	
<b>07852</b>	Disco Pto Diametro 280 mm Luk originale - Pto Disc Diameter 280 mm Original Luk		TD 55 D, TD 60 D, TD 60 STRADDLE MOUNT, TD 65 B - D, TD 70 D, TD 70 STRADDLE MOUNT, TD 75 D, TD 80 D, TD 80 STRADDLE MOUNT, TD 85 D, TD 90 D, TD 90 STRADDLE MOUNT, TD4020F - TD4030F - TD4040F, TD5.75 - TD5.80, TD5.85 - TD5.90, TD5010 - TD5020 - TD5030, TD85D, TD90D, TK4030, TK80.66 DT, TT 65 D	5145715, 5154703	
<b>LUK500045900</b>	Cuscinetto reggispinta 90 x 50 x 21,60 mm / Thrust Bearing 90 x 50 x 21,60 mm		TD 60 D PLUS, TD 65 F, TD 70 D PLUS, TD 75 F, TD 80 D, TD 80 D PLUS, TD 85 F, TD 90 D, TD 90 D PLUS, TD4020F, TD4030F, TD4040F, TD5.75, TD5.80, TD5.85, TD5.90, TD5010, TD5020, TD5030, TL100, TL80, TL90, TL70A, TL80A, TL90A, TN55, TN65, TN70D, TN60A, TN55S, TN65S, TN70S, TN75S, TN60SA, TN60VA, TN70VA, TN75VA, TN95VA, TN70A, TN75A, TN55D, TN65D, TN60DA, TN70DA, TN75DA, TN70F, TN75F, TN70SA, TN75SA, TN55V, TN65V, TN75V, TN55V, TN65V, TN75V, TN80F, TN95F, TN75FA, TN85FA, TN95FA, TN65N, TN75N, TN70NA	5122028, 82824591, 82824592, 87289219, 87345759, 87541562, 9976506	
<b>LUK500028400</b>	Cuscinetto pto 110 x 70 x 20 mm / Pto Bearing 110 x 70 x 20 mm		T7030-T7040-T7050-T7060-T7070, TD4020F-TD4030F-TD4040F, TD5.100-TD5.105, TD5.110-TD5.115, TD5.65-TD5.75-TD5.80, TD5.85-TD5.90-TD5.95, TD5010-TD5020-TD5030, TD5040-TD5050, TD60-TD70-TD80-TD90-TD95, TD60D-TD70D-TD80D-TD90D-TD95D, TD65B, TD65F-TD75F-TD85F, TD85D, TD90D, TK4030, TK80.66DT, TT50-TT55-TT65-TT65D-TT75	24905360	
<b>LUK410002500</b>	Cuscinetto volano 47 x 17 x 14 mm - Bearing 47 x 17 x 14 mm		L65 - L75 - L85 - L95, T4.75 - T4.85, T4.95 - T4.105, T4020 - T4020V, T4030 - T4030F, T4030N - T4030V, T4040, T4040 - T4040F, T4040N - T4040V, T4050F - T4050N - T4050V, T5030 - T5040, T5050 - T5060, TD 55 D, TD 60 D, TD 60 STRADDLE MOUNT, TD 65 B - D, TD 70 D, TD 70 STRADDLE MOUNT, TD 75 D, TD 80 D, TD 80 STRADDLE MOUNT, TD 85 D, TD 90 D, TD 90 STRADDLE MOUNT, TD4020F, TD4030F, TD4040F, TD5.75, TD5.80, TD5.85, TD5.90, TD5010, TD5020, TD5030, TD5040 - TD5050, TL70 - TL75, TL70A - TL80A - TL90A - TL100A, TL75E - TL85E - TL95E, TL80 - TL85, TL90 - TL95 - TL100, TN65F, TN70F - TN70NA, TN75F - TN75FA, TN80F, TN85A - TN85DA, TN85FA - TN85SA, TN90F, TN95A - TN95DA, TN95F, TN95FA, TN95NA - TN95VA, TT 65 D	28043280	



**KIT FRIZIONE LUK ORIGINALE RIF. MECCANISMO 5177618**

KIT EMBRAYAGE LUK ORIGINAL REF. 5177618  
 KIT CLUTCH ORIGINAL LUK REF. 5177618  
 KIT KUPPLUNG LUK REF. 5177618  
 KIT EMBRAGUE LUK ORIGINAL REF. 5177618

Art./Ref.	Note/Note	Brand	Applicazione/Application	Rif. Orig./Orig. Ref.	Immagine/Image
07877	Meccanismo Frizione 13" - Luk originale	NEW HOLLAND	M100 - M115 - M135, TM110 - TM115, TM120 - TM125, TM130 - TM140	5177618	
07878	Disco avanzamento 330 mm a 5 pale Luk originale - Clutch Disc Diameter 330 mm 5 pairs of pads Original Luk		M100 - M115 - M135, TM110 - TM115, TM120 - TM125, TM130 - TM140	5165650	
LUK500085130	Cuscinetto reggispinta completo 115 x 65 x 30 mm / Bearing + carrier assy 115 x 65 x 30 mm		M100 - M115 - M135, TM110 - TM120 - TM130 - TM135, TM115 - TM125, TM125, TM140 - TM150, TM7010 - TM7020, TM7030 - TM7040	5149611, 9967339	

**KIT FRIZIONE LUK ORIGINALE RIF. MECCANISMO 5092803**

KIT EMBRAYAGE LUK ORIGINAL REF. 5092803  
 KIT CLUTCH ORIGINAL LUK REF. 5092803  
 KIT KUPPLUNG LUK REF. 5092803  
 KIT EMBRAGUE LUK ORIGINAL REF. 5092803

Art./Ref.	Note/Note	Brand	Applicazione/Application	Rif. Orig./Orig. Ref.	Immagine/Image
VALE0805980	Meccanismo Frizione 12" - Valeo originale	NEW HOLLAND	TD5040, TD5050, TD60, TD60D PLUS, TD70, TD70D PLUS, TD80, TD80D PLUS, TD90, TD90D PLUS, TD95, TD95 STRADDLE MOUNT, TD95D, TD95D PLUS	5092803, 84177332	
LUK331032310	Disco Pto Diametro 310 mm Luk originale - Pto Disc Diameter 310 mm Original Luk		TD5040, TD5050, TD60, TD60D PLUS, TD70, TD70D PLUS, TD80, TD80D PLUS, TD90, TD90D PLUS, TD95, TD95 STRADDLE MOUNT, TD95D, TD95D PLUS	5089337, 5092802	
LUK500045900	Cuscinetto reggispinta 90 x 50 x 21,60 mm / Thrust Bearing 90 x 50 x 21,60 mm		TD 60 D PLUS, TD 65 F, TD 70 D PLUS, TD 75 F, TD 80 D, TD 80 D PLUS, TD 85 F, TD 90 D, TD 90 D PLUS, TD4020F, TD4030F, TD4040F, TD5.75, TD5.80, TD5.85, TD5.90, TD5010, TD5020, TD5030, TL100, TL80, TL90, TL70A, TL80A, TL90A, TN55, TN65, TN70D, TN60A, TN55S, TN65S, TN70S, TN75S, TN60SA, TN60VA, TN70VA, TN75VA, TN95VA, TN70A, TN75A, TN55D, TN65D, TN60DA, TN70DA, TN75DA, TN70F, TN75F, TN70SA, TN75SA, TN55V, TN65V, TN75V, TN55V, TN65V, TN75V, TN80F, TN95F, TN75FA, TN85FA, TN95FA, TN65N, TN75N, TN70NA	5122028, 82824591, 82824592, 87289219, 87345759, 87541562, 9976506	
LUK500028400	Cuscinetto pto 110 x 70 x 20 mm / Pto Bearing 110 x 70 x 20 mm		T7030-T7040-T7050-T7060-T7070, TD4020F-TD4030F-TD4040F, TD5.100-TD5.105, TD5.110-TD5.115, TD5.65-TD5.75-TD5.80, TD5.85-TD5.90-TD5.95, TD5010-TD5020-TD5030, TD5040-TD5050, TD60-TD70-TD80-TD90-TD95, TD60D-TD70D-TD80D-TD90D-TD95D, TD65B, TD65F-TD75F-TD85F, TD85D, TD90D, TK4030, TK80.66DT, TT50-TT55-TT65-TT65D-TT75	24905360	
LUK410002500	Cuscinetto volano 47 x 17 x 14 mm - Bearing 47 x 17 x 14 mm		L65 - L75 - L85 - L95, T4.75 - T4.85, T4.95 - T4.105, T4020 - T4020V, T4030 - T4030F, T4030N - T4030V, T4040, T4040 - T4040F, T4040N - T4040V, T4050F - T4050N - T4050V, T5030 - T5040, T5050 - T5060, TD 55 D, TD 60 D, TD 60 STRADDLE MOUNT, TD 65 B - D, TD 70 D, TD 70 STRADDLE MOUNT, TD 75 D, TD 80 D, TD 80 STRADDLE MOUNT, TD 85 D, TD 90 D, TD 90 STRADDLE MOUNT, TD4020F, TD4030F, TD4040F, TD5.75, TD5.80, TD5.85, TD5.90, TD5010, TD5020, TD5030, TD5040 - TD5050, TL70 - TL75, TL70A - TL80A - TL90A - TL100A, TL75E - TL85E - TL95E, TL80 - TL85, TL90 - TL95 - TL100, TN65F, TN70F - TN70NA, TN75F - TN75FA, TN80F, TN85A - TN85DA, TN85FA - TN85SA, TN90F, TN95A - TN95DA, TN95F, TN95FA, TN95NA - TN95VA, TT 65 D	28043280	





**MECCANISMO + DISCO PTO ORIGINALE LUK RIF. 623306509**

MECANISME + DISQUE PTO ORIGINAL LUK 623306509

COVER ASSEMBLY + ORIGINAL PTO DISC LUK REF. 623306509

GETRIEBE + ZAPFWELLENSCHEIBE LUK 623306509

MECANISMO + DISCO PTO ORIGINAL LUK REF. 623306509

Art./Ref.	Note/Note	Brand	Applicazione/Application	Rif. Orig./Orig. Ref.	Immagine/Image
<b>LUK623306509</b>	Kit tutto originale LUK composto da - Kit all LUK original consists of: - Meccanismo/Clutch Ref. 223 0028 10 - Disco Pto/Disc Pto 323 0471 10		T3010 - T3020 - T3030 - T3040, TCE40 - TCE45 - TCE50 - TCE55	87291158	
<b>LUK500045900</b>	Cuscinetto reggispinta 90 x 50 x 21,60 mm / Thrust Bearing 90 x 50 x 21,60 mm	<b>NEW HOLLAND</b>	TD 60 D PLUS, TD 65 F, TD 70 D PLUS, TD 75 F, TD 80 D, TD 80 D PLUS, TD 85 F, TD 90 D, TD 90 D PLUS, TD4020F, TD4030F, TD4040F, TD5.75, TD5.80, TD5.85, TD5.90, TD5010, TD5020, TD5030, TL100, TL80, TL90, TL70A, TL80A, TL90A, TN55, TN65, TN70D, TN60A, TN55S, TN65S, TN70S, TN75S, TN60SA, TN60VA, TN70VA, TN75VA, TN95VA, TN70A, TN75A, TN55D, TN65D, TN60DA, TN70DA, TN75DA, TN70F, TN75F, TN70SA, TN75SA, TN55V, TN65V, TN75V, TN55V, TN65V, TN75V, TN80F, TN95F, TN75FA, TN85FA, TN95FA, TN65N, TN75N, TN70NA	5122028, 82824591, 82824592, 87289219, 87345759, 87541562, 9976506	
<b>LUK500067300</b>	Cuscinetto pto 100 x 65 x 18 mm / Pto Bearing 100 x 65 x 18 mm		T3010 - T3020 - T3030 - T3040, TCE40 - TCE45 - TCE50 - TCE55	24905350	
<b>LUK410002400</b>	Cuscinetto volano 35 x 15 x 11 mm - Bearing 35 x 15 x 11 mm		T3010 - T3020 - T3030 - T3040, TCE40 - TCE45 - TCE50 - TCE55	9975291	

**KIT FRIZIONE LUK ADATTABILE RIF. 87689675 STEYR**

KIT EMBRAYAGE LUK ADAPTABLE REF. 87689675 STEYR

KIT CLUTCH LUK ADAPTABLE REF. 87689675 STEYR

KIT KUPPLUNG LUK PASSEND ZU REF. 87689675 STEYR

KIT EMBRAGUE LUK ADAPTABLE REF. 87689675 STEYR

Art./Ref.	Note/Note	Brand	Applicazione/Application	Rif. Orig./Orig. Ref.	Immagine/Image
<b>LUK628308610</b>	Kit tutto originale LUK composto da - Kit all LUK original consists of: - Meccanismo/Clutch Ref. 228 0184 0 - Disco Pto/Disc Pto 328 0332 10 - Cuscinetto/Bearing Ref. 500 0459 00 - Cuscinetto/Bearing Ref. 500 1292 10 - Cuscinetto/Bearing Ref. 410 0025 00	<b>STEYR</b>	4065 KOMPAKT, 4075 KOMPAKT	87689675	

Art./Ref.	Note/Note	Brand	Applicazione/Application	Rif. Orig./Orig. Ref.	Immagine/Image
29416	Meccanismo Frizione 11" - Luk originale	STEYR	370 - 375 KOMPACT, 4065 KOMPACT, 4075 KOMPACT, 4085 KOMPACT, 485 - 495 KOMPACT	5181421, 5196813, 87732504, 87732506	
29414	Disco Pto Diametro 280 mm Luk originale - Pto Disc Diameter 280 mm Original Luk		370 - 375 KOMPACT, 4065 KOMPACT, 4075 KOMPACT, 4085 KOMPACT, 485 - 495 KOMPACT	47134874, 5176450	
LUK500045900	Cuscinetto reggispira 90 x 50 x 21,60 mm / Thrust Bearing 90 x 50 x 21,60 mm		360 KOMP.(SYNCHRO SHIFT 16X16), 370 KOMPACT, 375 KOMPACT, 485 KOMPACT, 4055S KOMPACT, 4065 KOMPACT, 4065S KOMPACT, 4075 KOMPACT, 4085 KOMPACT, 4095 KOMPACT, 485 KOMPACT, 495 KOMPACT, M952, M963KOMP.(SYNCHRO SHIFT 16X16)	87345759	
LUK500129210	Cuscinetto pto 115 x 75 x 20 mm / Pto Bearing 115 x 75 x 20 mm		370 - 375 KOMPACT, 4065 KOMPACT, 4075 KOMPACT, 4085 KOMPACT, 485 - 495 KOMPACT	5112084	
LUK410002500	Cuscinetto volano 47 x 17 x 14 mm - Bearing 47 x 17 x 14 mm		370 - 375 KOMPACT, 4065 KOMPACT, 4075 KOMPACT, 4085 KOMPACT, 485 - 495 KOMPACT	28043280	

**KIT FRIZIONE LUK ORIGINALE RIF. 628318112**

KIT EMBRAYAGE LUK ORIGINAL REF. 628318112

KIT CLUTCH ORIGINAL LUK REF. 628318112

KIT KUPPLUNG LUK REF. 628318112

KIT EMBRAGUE LUK ORIGINAL REF. 628318112

Art./Ref.	Note/Note	Brand	Applicazione/Application	Rif. Orig./Orig. Ref.	Immagine/Image
LUK628318112	Kit tutto originale LUK composto da - Kit all LUK original consists of: - Meccanismo/Clutch Ref. 128 0302 10 - Disco Pto/Disc Pto 328 0332 11 - Cuscinetto/Bearing Ref. 500 1292 10 - Cuscinetto/Bearing Ref. 410 0133 10	STEYR	360 KOMPACT, 370 KOMPACT, 375 KOMPACT, 4065 KOMPACT, 4075 KOMPACT, 4085 KOMPACT, 485 KOMPACT, 495 KOMPACT	47134884, 5186548, 5196770, 87732490	    
29865	Meccanismo Frizione 11" - Luk Originale		360 KOMPACT, 370 KOMPACT, 375 KOMPACT, 4065 KOMPACT, 4075 KOMPACT, 4085 KOMPACT, 485 KOMPACT, 495 KOMPACT	47134884, 5186548, 5196770, 87732490	
29414	Disco Pto Diametro 280 mm Luk originale - Pto Disc Diameter 280 mm Original Luk		360 KOMPACT, 370 - 375 KOMPACT, 4065 KOMPACT, 4075 KOMPACT, 4085 KOMPACT, 485 - 495 KOMPACT	47134874, 5176450	
LUK500129210	Cuscinetto pto 115 x 75 x 20 mm / Pto Bearing 115 x 75 x 20 mm		360 KOMPACT, 370 - 375 KOMPACT, 4065 KOMPACT, 4075 KOMPACT, 4085 KOMPACT, 485 - 495 KOMPACT	5112084	
LUK410013310	Cuscinetto volano 40 x 17 x 12 mm - Bearing 40 x 17 x 12 mm		360 KOMPACT, 370 KOMPACT, 375 KOMPACT, 4065 KOMPACT, 4075 KOMPACT, 4085 KOMPACT, 485 KOMPACT, 495 KOMPACT	87729147	

**KIT FRIZIONE ADATTABILE RIF. 628052210 LANDINI**

KIT EMBRAYAGE ADAPTABLE REF. 628052210 LANDINI

KIT CLUTCH ADAPTABLE REF. 628052210 LANDINI

KIT KUPPLUNG PASSEND ZU REF. 628052210 LANDINI

KIT EMBRAGUE ADAPTABLE REF. 628052210 LANDINI

Art./Ref.	Note/Note	Brand	Applicazione/Application	Rif. Orig./Orig. Ref.	Immagine/Image
83940	Kit composto da - Kit consists of: - Meccanismo/Clutch Ref. 3540480M92 With box Original LANDINI - Disco Pto/Disc Pto Ref. 1424135M93 Not Original - Cuscinetto/Bearing Ref. 1423473M94 Not Original - Cuscinetto/Bearing Ref. 1442381X1 Not Original		4530V-5530F-5530L-5530V-6030F, 5830-6030-6830-7830, 5840-6040-6840, 5860-6060-7860, 5860-8860, 6060F-6060L-6060V, 6070-6870-7870-8870, 6500-7500-8500, 6550-7550-8550, 6880-6880VM, 7530F-7530L-8830, 7880, ADVANTAGE 55F-55FP-55GE, ADVANTAGE 55GT-55GTP-55LP-55V, ADVANTAGE 60F-60FP-60GE-60GT, ADVANTAGE 60GTP-60L-60LP, ADVANTAGE 75F-75FP-75GE-75GT, ADVANTAGE 75GTP-75L-75LP-75V, ADVANTAGE 85F-85FP-85GE-85GT, ADVANTAGE 85GTP-85L-85LP, ATLAS 80 - 85 - 90 - 100, ATLATINS 80 - 85 - 90 - 100, BLIZZARD 50 - 60 - 75 - 85, CINGOLATI C4830-C5830, CINGOLATI C6830-C7830, GHIBLI 80 - 90 - 100, GHIBLI 85 - 95 - 105, POWERFARM 60, POWERFARM 75 - 85 - 95 - 105, REX 80FP - 80GE - 80GTP, REX CAB 60, TREKKER 65F, TREKKER CF55 - CF60 - CF75	3540480M91, 3540480M92	
LN3540480M91	Meccanismo Frizione 11" - Landini originale		4530V-5530F-5530L-5530V-6030F, 5830-6030-6830-7830, 5840-6040-6840, 5860-6060-7860, 5860-8860, 6060F-6060L-6060V, 6070-6870-7870-8870, 6500-7500-8500, 6550-7550-8550, 6880-6880VM, 7530F-7530L-8830, 7880, ADVANTAGE 55F-55FP-55GE, ADVANTAGE 55GT-55GTP-55LP-55V, ADVANTAGE 60F-60FP-60GE-60GT, ADVANTAGE 60GTP-60L-60LP, ADVANTAGE 75F-75FP-75GE-75GT, ADVANTAGE 75GTP-75L-75LP-75V, ADVANTAGE 85F-85FP-85GE-85GT, ADVANTAGE 85GTP-85L-85LP, ATLAS 80 - 85 - 90 - 100, ATLATINS 80 - 85 - 90 - 100, BLIZZARD 50 - 60 - 75 - 85, CINGOLATI C4830-C5830, CINGOLATI C6830-C7830, GHIBLI 80 - 90 - 100, GHIBLI 85 - 95 - 105, POWERFARM 60, POWERFARM 75 - 85 - 95 - 105, REX 80FP - 80GE - 80GTP, REX CAB 60, TREKKER 65F, TREKKER CF55 - CF60 - CF75	3540480M91, 3540480M92	
70467	Disco Pto Diametro 280 mm - Pto Disc Diameter 280 mm	LANDINI	5500, 5830, 5840, 5860, 5860 (DAL P50187, 5870, 5870 (DAL P50187)), 6030, 6040, 6060, 6060(DAL P50187), 6070, 6070 (DAL P50187), 6500, 6550, 6830, 6840, 6860, 6870, 6880, 7500, 7550, 7830, 7860, 7870, 8500, 8550, 8830, 8860, 8870, ADVANTAGE CAB E F.S:55, ADVANTAGE CAB E F.S:60, ADVANTAGE CAB E F.S:65, ADVANTAGE CAB E F.S:75, ADVANTAGE CAB E F.S:85, ATLAS:100, ATLAS:70, ATLAS:75, ATLAS:80, ATLAS:85, ATLAS:90, BLIZZARD:50, BLIZZARD:60, BLIZZARD:65, BLIZZARD:75, BLIZZARD:85, CINGOLATI: C5500, CINGOLATI: CF5830, CINGOLATI: CF6030, CINGOLATI:8860, CINGOLATI:C4500, CINGOLATI:C4830 CINGOLATI:C5830, CINGOLATI:C6500, CINGOLATI:C6830, CINGOLATI:C7800, CINGOLATI:C7830, CINGOLATI:CF4830, CINGOLATI:CF5030, CINGOLATI:CF6060, CINGOLATI:CF6830, FRUTTETI 530 F/L/V:4530, FRUTTETI 530 F/L/V:5530, FRUTTETI 530 F/L/V:6030, FRUTTETI 530 F/L/V:6530, FRUTTETI 530 F/L/V:7530, FRUTTETI 530 F/L/V:8530, FRUTTETI 560 F/L/V:5560, FRUTTETI 560 F/L/V:5560V/L, FRUTTETI 560 F/L/V:6060, FRUTTETI 560 F/L/V:6060V/L, FRUTTETI 560 F/L/V:6560, FRUTTETI 560 F/L/V:7560, FRUTTETI 560 F/L/V:8560, POWER FARM:60, POWER FARM:75, POWER FARM:85, REX CAB E FOOT STEP:60, REX CAB E FOOT STEP:70, REX CAB E FOOT STEP:80, REX NEW TIER 2:60, REX NEW TIER 2:75, REX NEW TIER 2:85, SERIE 60 NEW :6860, SERIE 60 NEW :8860, TREKKER :C75, TREKKER :CF65, TREKKER :CF70, TREKKER :CF75, TREKKER :CF85, TREKKER COMPACT TIER 2:CF60, TREKKER COMPACT TIER 2:CF70, TREKKER NEW TIER 2:75, TREKKER NEW TIER 2:85, TREKKER NEW:70C/F/L, TREKKER NEW:80C/F/L, TREKKER:CF55, TREKKER:CF60, VIGNETI CAB E FOOT STEP :55V, VIGNETI CAB E FOOT STEP :60V, VIGNETI CAB E FOOT STEP :65V, VIGNETI CAB E FOOT STEP :75V, VIGNETI CAB E FOOT STEP:75V, VIGNETI REX CAB :60V, VIGNETI REX CAB :65V., VIGNETI REX CAB TIER 2 :75V	1424135M91, 1424135M93	
12841	Cuscinetto reggispinta 90 x 50 x 21,60 mm / Thrust Bearing 90 x 50 x 21,60 mm		4530V,5530F,5530L,5530V,5830, 5500,6500,7500,8500,5860,6060, 5840,6040,6840,6550,7550,8550, 6030,6030F,6030L,6030V,6530F, 6060F/L/V,6860,7860,5860,6860, 6530L,6530V,6830,7530F,7530L, 6870,7870,8870,6880,7880,8880, 7830,8530F,8530L,8830, 7860,8860,5865,6865,7860,8865, 9880,C4830,C5830,C6830,C7830, GHIBLI 80/90/100, GHIBLI TIER2 85/95/105, GLOBALFARM 90/95/100/105, GLOBUS 55, POWERFARM 60/75/85/95/105, REX 100FP/GE/GTP, REX 60FP/GE/LP, REX 60V/65V/70V/80V, REX 70/FP/GE/GTP/LP, REX 80FP/GE/GTP/LP, REX 90FP/GE/GTP, REX CAB 60/70/80/90/100, REX TIER2 105F/GE/GT/, REX TIER2 60F/GE, REX TIER2 70F/GE, REX TIER2 75F/GE/GT, REX TIER2 80F/GE, REX TIER2 85F/GE/GT, REX TIER2 90GT, REX TIER2 95F/GE/GT, TREKKER 100C, TREKKER 105C/F/M, TREKKER 70C/F/L, TREKKER 75C/F/M, TREKKER 80C/F/L, TREKKER 85C/F/M, TREKKER 90C/F/L, TREKKER 95C/F/M, TREKKER CF60/CF70, VIGNETI 55V, VIGNETI 60V/65V/70V/80/, VIGNETI 75V	1423473M91, 1423473M93, 1423473M94, 391347X1	

Art./Ref.	Note/Note	Brand	Applicazione/Application	Rif. Orig./Orig. Ref.	Immagine/Image
15757	Cuscinetto pto 100 x 65 x 11 mm / Pto Bearing 100 x 65 x 11 mm	LANDINI	5500, 5830, 5840, 5860, 5860 (DAL P50187, 5870, 5870 (DAL P50187), 6030, 6040, 6060, 6060(DAL P50187), 6070, 6070 (DAL P50187), 6840, 6870, 6880, 7500, 7550, 7830, 7860, 7870, 7880, 8500, 8550, 8930, 8860, 8870, 8880, 9060, 9080, 9880, ADVANTAGE CAB E F.S.:55, ADVANTAGE CAB E F.S.:60, ADVANTAGE CAB E F.S.:65, ADVANTAGE CAB E F.S.:85, ADVANTAGE CAB E F.S.:95, ATLANTIS 100,70,75,80,85,90, ATLAS:100, ATLAS:70, ATLAS:75, ATLAS:80, ATLAS:85, ATLAS:90, BLIZZARD:50, BLIZZARD:60, BLIZZARD:65, BLIZZARD:75, BLIZZARD:85, BLIZZARD:95, CINGOLATI: CF6030, CINGOLATI:8860, CINGOLATI:C4500, CINGOLATI:C6500, CINGOLATI:C6830, CINGOLATI:C7800, CINGOLATI:CF5030, CINGOLATI:CF6830, FRUTTETI 530 F/L/V:4530, FRUTTETI 530 F/L/V:5530, FRUTTETI 530 F/L/V:6030, FRUTTETI 530 F/L/V:6530, FRUTTETI 530 F/L/V:7530, FRUTTETI 530 F/L/V:8530, FRUTTETI 560 F/L/V:5560, FRUTTETI 560 F/L/V:5560V/L, FRUTTETI 560 F/L/V:6060, FRUTTETI 560 F/L/V:6060V/L, FRUTTETI 560 F/L/V:6560, FRUTTETI 560 F/L/V:7560, FRUTTETI 560 F/L/V:8560, GHIBLI NEW TIER 2:105, GHIBLI NEW TIER 2:85, GHIBLI NEW TIER 2:95, GHIBLI: 80, GHIBLI:90, POWER FARM:105, POWER FARM:60, POWER FARM:75, POWER FARM:85, POWER FARM:95, REX CAB E FOOT STEP: 100, REX CAB E FOOT STEP: 70, REX CAB E FOOT STEP: 80, REX CAB E FOOT STEP: 90, REX CAB E FOOT STEP:60, REX CAB E FOOT STEP:70, REX CAB E FOOT STEP:80, REX NEW TIER 2:60, REX NEW TIER 2:75, REX NEW TIER 2:85, REX TIER 2 FP/CAB:105, REX TIER 2 FP/CAB:75, REX TIER 2 FP/CAB:85, REX TIER 2 FP/CAB:95, SERIE 60 NEW :6860, SERIE 60 NEW:5860, SERIE 60 NEW:7860, SERIE 60 NEW:8860, TREKKER :CF70, TREKKER :CF75, TREKKER COMPACT TIER 2:CF60, TREKKER COMPACT TIER 2:CF70, TREKKER NEW TIER 2:105, TREKKER NEW TIER 2:75, TREKKER NEW TIER 2:85, TREKKER NEW TIER 2:95, TREKKER NEW:100C, TREKKER NEW:70 C/F/L, TREKKER NEW:70C/F/L, TREKKER NEW:80 C/F/L, TREKKER NEW:80C/F/L, TREKKER NEW:90 C/F/L, TREKKER:CF75, TREKKER:C85, TREKKER:C95, VIGNETI CAB E FOOT STEP :65V, VIGNETI CAB E FOOT STEP :75V, VIGNETI CAB E FOOT STEP:65V, VIGNETI CAB E FOOT STEP:75V, VIGNETI REX CAB :65V., VIGNETI REX CAB TIER 2 :75V, VIGNETI REX CAB TIER 2:85V, VIGNETI REX CAB:70V, VIGNETI REX CAB:80V	1442381X1	
85025	Kit composto da - Kit consists of: - Meccanismo/Clutch Ref. 3540480M92 With box Original LUK - Disco Pto/Disc Pto Ref. 1424135M93 Not Original - Cuscinetto/Bearing Ref. 1423473M94 Not Original - Cuscinetto/Bearing Ref. 1442381X1 Not Original	LANDINI	4530V-5530F-5530L-5530V-6030F, 5830-6030-6830-7830, 5840-6040-6840, 5860-6060-7860, 5860-8860, 6060F-6060L-6060V, 6070-6870-7870-8870, 6500-7500-8500, 6550-7550-8550, 6880-6880VM, 7530F-7530L-8830, 7880, ADVANTAGE 55F-55FP-55GE, ADVANTAGE 55GT-55GTP-55LP-55V, ADVANTAGE 60F-60FP-60GE-60GT, ADVANTAGE 60GTP-60L-60LP, ADVANTAGE 75F-75FP-75GE-75GT, ADVANTAGE 75GTP-75L-75LP-75V, ADVANTAGE 85F-85FP-85GE-85GT, ADVANTAGE 85GTP-85L-85LP, ATLAS 80 - 85 - 90 - 100, ATLANTIS 80 - 85 - 90 - 100, BLIZZARD 50 - 60 - 75 - 85, CINGOLATI C4830-C5830, CINGOLATI C6830-C7830, GHIBLI 80 - 90 - 100, GHIBLI 85 - 95 - 105, POWERFARM 60, POWERFARM 75 - 85 - 95 - 105, REX 80FP - 80GE - 80GTP, REX CAB 60, TREKKER 65F, TREKKER CF55 - CF60 - CF75	3540480M91, 3540480M92	
07898	Meccanismo Frizione 11" - Luk originale	LANDINI	4530V, 5500,6500,5860,6060,6060F/L/V, 5530F/L/V,5830,6030F/L/V, 5840,6040,6840,6550,7550,8550, 6530F/L/V,6830,7530L,8830, 6870,7870,8870, 6880, 7500, 7550, 7830, 7860, 7870, 8500, 8550, 8830, 8860, 8870, ADVANTAGE 75F/FP/GE/GT/GTP/L, ADVANTAGE 75LP/V, ADVANTAGE 85F/FP/GE/GT/GTP/L, ATLANTIS 100/80/85/90, ATLAS: 100, ATLAS: 80, ATLAS: 85, ATLAS: 90, BLIZZARD 65, BLIZZARD: 75, BLIZZARD: 85, C4830,C5830,C6830,C7830, CINGOLATI:8860, CINGOLATI:C7800, FRUTTETI 530 F/L/V:7530, FRUTTETI 530 F/L/V:8530, FRUTTETI 560 F/L/V:7560, FRUTTETI 560 F/L/V:8560, GHIBLI 100/80/90, GHIBLI TIER2 105/85/95, POWER FARM: 75, POWER FARM: 85, POWERFARM 105/60/95, REX CAB E F.S: 80, REX NEW TIER 2: 75, REX NEW TIER 2: 85, TREKKER NEW TIER 2: 75, TREKKER NEW TIER 2: 85, TREKKER NEW: 70 C/F/L, TREKKER NEW: 80 C/F/L, TREKKER: CF70 TREKKER: CF75, VIGNETI CAB E F.S: 75V	3540480M91, 3540480M92	

Art./Ref.	Note/Note	Brand	Applicazione/Application	Rif. Orig./Orig. Ref.	Immagine/Image
<b>70467</b>	Disco Pto Diametro 280 mm - Pto Disc Diameter 280 mm		5500, 5830, 5840, 5860, 5860 (DAL P50187, 5870, 5870 (DAL P50187)), 6030, 6040, 6060, 6060(DAL P50187), 6070, 6070 (DAL P50187), 6500, 6550, 6830, 6840, 6860, 6870, 6880, 7500, 7550, 7830, 7860, 7870, 8500, 8550, 8830, 8860, 8870, ADVANTAGE CAB E F.S.:55, ADVANTAGE CAB E F.S.:60, ADVANTAGE CAB E F.S.:65, ADVANTAGE CAB E F.S.:75, ADVANTAGE CAB E F.S.:85, ATLAS:100, ATLAS:70, ATLAS:75, ATLAS:80, ATLAS:85, ATLAS:90, BLIZZARD:50, BLIZZARD:60, BLIZZARD:65, BLIZZARD:75, BLIZZARD:85, CINGOLATI: C5500, CINGOLATI: C5830, CINGOLATI: CF6030, CINGOLATI:8860, CINGOLATI:C4500, CINGOLATI:C4830, CINGOLATI:C5830, CINGOLATI:C6500, CINGOLATI:C6830, CINGOLATI:C7800, CINGOLATI:C7830, CINGOLATI:CF4830, CINGOLATI:CF5030, CINGOLATI:CF6060, CINGOLATI:CF6830, FRUTTETI 530 F/L/V:4530, FRUTTETI 530 F/L/V:5530, FRUTTETI 530 F/L/V:6030, FRUTTETI 530 F/L/V:6530, FRUTTETI 530 F/L/V:7530, FRUTTETI 530 F/L/V:8530, FRUTTETI 560 F/L/V:5560, FRUTTETI 560 F/L/V:5560V/L, FRUTTETI 560 F/L/V:6060, FRUTTETI 560 F/L/V:6060V/L, FRUTTETI 560 F/L/V:6560, FRUTTETI 560 F/L/V:7560, FRUTTETI 560 F/L/V:8560, POWER FARM:60, POWER FARM:75, POWER FARM:85, REX CAB E FOOT STEP:60, REX CAB E FOOT STEP:70, REX CAB E FOOT STEP:80, REX NEW TIER 2:60, REX NEW TIER 2:75, REX NEW TIER 2:85, SERIE 60 NEW :6860, SERIE 60 NEW:5860, TREKKER :C75, TREKKER :CF65, TREKKER :CF70, TREKKER :CF75, TREKKER :CF85, TREKKER COMPACT TIER 2:CF60, TREKKER COMPACT TIER 2:CF70, TREKKER NEW TIER 2:75, TREKKER NEW TIER 2:85, TREKKER NEW:70C/F/L, TREKKER NEW:80C/F/L, TREKKER:CF55, TREKKER:CF60, VIGNETI CAB E FOOT STEP :55V, VIGNETI CAB E FOOT STEP :60V, VIGNETI CAB E FOOT STEP :65V, VIGNETI CAB E FOOT STEP :75V, VIGNETI CAB E FOOT STEP:75V, VIGNETI REX CAB :60V, VIGNETI REX CAB :65V., VIGNETI REX CAB TIER 2 :75V	1424135M91, 1424135M93	
<b>12841</b>	Cuscinetto reggispinna 90 x 50 x 21,60 mm / Thrust Bearing 90 x 50 x 21,60 mm	<b>LANDINI</b>	4530V,5530F,5530L,5530V,5830, 5500,6500,7500,8500,5860,6060, 5840,6040,6840,6550,7550,8550, 6030,6030F,6030L,6030V,6530F, 6060F/L/V,6860,7860,5860,6860, 6530L,6530V,6830,7530F,7530L, 6870,7870,8870,6880,7880,8880, 7830,8530F,8530L,8830, 7860,8860,5865,6865,7860,8865, 9880,C4830,C5830,C6830,C7830, GHIBLI 80/90/100, GHIBLI TIER2 85/95/105, GLOBALFARM 90/95/100/105, GLOBUS 55, POWERFARM 60/75/85/95/105, REX 100FP/GE/GTP, REX 60FP/GE/LP, REX 60V/65V/70V/80V, REX 70FP/GE/GTP/LP, REX 80FP/GE/GTP/LP, REX 90FP/GE/GTP, REX CAB 60/70/80/90/100, REX TIER2 105F/GE/GT/, REX TIER2 60F/GE, REX TIER2 70F/GE, REX TIER2 75F/GE/GT, REX TIER2 80F/GE, REX TIER2 85F/GE/GT, REX TIER2 90GT, REX TIER2 95F/GE/GT, TREKKER 100C, TREKKER 105C/F/M, TREKKER 70C/F/L, TREKKER 75C/F/M, TREKKER 80C/F/L, TREKKER 85C/F/M, TREKKER 90C/F/L, TREKKER 95C/F/M, TREKKER CF60/CF70, VIGNETI 55V, VIGNETI 60V/65V/70V/80V, VIGNETI 75V	1423473M91, 1423473M93, 1423473M94, 391347X1	
<b>15757</b>	Cuscinetto pto 100 x 65 x 11 mm / Pto Bearing 100 x 65 x 11 mm		5500, 5830, 5840, 5860, 5860 (DAL P50187, 5870, 5870 (DAL P50187)), 6030, 6040, 6060, 6060(DAL P50187), 6070, 6070 (DAL P50187), 6840, 6870, 6880, 7500, 7550, 7830, 7860, 7870, 7880, 8500, 8550, 8830, 8860, 8870, 8880, 9060, 9080, 9880, ADVANTAGE CAB E F.S.:55, ADVANTAGE CAB E F.S.:60, ADVANTAGE CAB E F.S.:65, ADVANTAGE CAB E F.S.:85, ADVANTAGE CAB E F.S.:95, ATLANTIS 100,70,75,80,85,90, ATLAS:100, ATLAS:70, ATLAS:75, ATLAS:80, ATLAS:85, ATLAS:90, BLIZZARD:50, BLIZZARD:60, BLIZZARD:65, BLIZZARD:75, BLIZZARD:85, BLIZZARD:95, CINGOLATI: CF6030, CINGOLATI:8860, CINGOLATI:C4500, CINGOLATI:C6500, CINGOLATI:C6830, CINGOLATI:C7800, CINGOLATI:CF5030, CINGOLATI:CF6830, FRUTTETI 530 F/L/V:4530, FRUTTETI 530 F/L/V:5530, FRUTTETI 530 F/L/V:6030, FRUTTETI 530 F/L/V:6530, FRUTTETI 530 F/L/V:7530, FRUTTETI 530 F/L/V:8530, FRUTTETI 560 F/L/V:5560, FRUTTETI 560 F/L/V:5560V/L, FRUTTETI 560 F/L/V:6060, FRUTTETI 560 F/L/V:6060V/L, FRUTTETI 560 F/L/V:6560, FRUTTETI 560 F/L/V:7560, FRUTTETI 560 F/L/V:8560, GHIBLI NEW TIER 2:105, GHIBLI NEW TIER 2:85, GHIBLI NEW TIER 2:95, GHIBLI: 80, GHIBLI:90, POWER FARM:105, POWER FARM:60, POWER FARM:75, POWER FARM:85, POWER FARM:95, REX CAB E FOOT STEP: 100, REX CAB E FOOT STEP: 70, REX CAB E FOOT STEP: 80, REX CAB E FOOT STEP: 90, REX CAB E FOOT STEP:60, REX CAB E FOOT STEP:70, REX CAB E FOOT STEP:80, REX NEW TIER 2:60, REX NEW TIER 2:75, REX NEW TIER 2:85, REX TIER 2 FP/CAB:105, REX TIER 2 FP/CAB:75, REX TIER 2 FP/CAB:85, REX TIER 2 FP/CAB:95, SERIE 60 NEW :6860, SERIE 60 NEW:5860, SERIE 60 NEW:7860, SERIE 60 NEW:8860, TREKKER :CF70, TREKKER :CF75, TREKKER COMPACT TIER 2:CF60, TREKKER COMPACT TIER 2:CF70, TREKKER NEW TIER 2:105, TREKKER NEW TIER 2:75, TREKKER NEW TIER 2:85, TREKKER NEW TIER 2:95, TREKKER NEW:100C, TREKKER NEW:70 C/F/L, TREKKER NEW:70C/F/L, TREKKER NEW:80 C/F/L, TREKKER NEW:80C/F/L, TREKKER NEW:90 C/F/L, TREKKER:C75, TREKKER:C85, TREKKER:C95, VIGNETI CAB E FOOT STEP :65V, VIGNETI CAB E FOOT STEP :75V, VIGNETI CAB E FOOT STEP:65V, VIGNETI CAB E FOOT STEP:75V, VIGNETI REX CAB :65V, VIGNETI REX CAB TIER 2 :75V, VIGNETI REX CAB TIER 2:85V, VIGNETI REX CAB :70V, VIGNETI REX CAB:80V	1442381X1	

Art./Ref.	Note/Note	Brand	Applicazione/Application	Rif. Orig./Orig. Ref.	Immagine/Image
<b>LUK628052210</b>	<p>Kit tutto originale LUK composto da - Kit all LUK original consists of:</p> <ul style="list-style-type: none"> <li>- Meccanismo/Clutch Ref. 228 0003 14</li> <li>- Disco Pto/Disc Pto 328 0083 16</li> <li>- Cuscinetto/Bearing Ref. 500 0459 00</li> <li>- Cuscinetto/Bearing Ref. 500 1107 10</li> <li>- Cuscinetto/Bearing Ref. 410 0042 10</li> </ul>		<p>4530V-5530F-5530L-5530V-6030F, 5830-6030-6830-7830, 5840-6040-6840, 5860-6060-7860, 5860-8860, 6060F-6060L-6060V, 6070-6870-7870-8870, 6500-7500-8500, 6550-7550-8550, 6880-6880VM, 7530F-7530L-8830, 7880, ADVANTAGE 55F-55FP-55GE, ADVANTAGE 55GT-55GTP-55LP-55V, ADVANTAGE 60F-60FP-60GE-60GT, ADVANTAGE 60GTP-60L-60LP, ADVANTAGE 75F-75FP-75GE-75GT, ADVANTAGE 75GTP-75L-75LP-75V, ADVANTAGE 85F-85FP-85GE-85GT, ADVANTAGE 85GTP-85L-85LP, ATLAS 80 - 85 - 90 - 100, ATLATINS 80 - 85 - 90 - 100, BLIZZARD 50 - 60 - 75 - 85, CINGOLATI C4830-C5830, CINGOLATI C6830-C7830, GHIBLI 80 - 90 - 100, GHIBLI 85 - 95 - 105, POWERFARM 60, POWERFARM 75 - 85 - 95 - 105, REX 80FP - 80GE - 80GTP, REX CAB 60, TREKKER 65F, TREKKER CF55 - CF60 - CF75</p>	<p>1423473M94, 1424135M94, 1442381X1, 339599X1, 3540480M91, 3540480M92</p>	
<b>LUK628052209</b>	<p>Kit tutto originale LUK composto da - Kit all LUK original consists of:</p> <ul style="list-style-type: none"> <li>- Meccanismo/Clutch Ref. 228 0003 14</li> <li>- Disco Pto/Disc Pto 328 0083 16</li> </ul>		<p>4530V-5530F-5530L-5530V-6030F, 5830-6030-6830-7830, 5840-6040-6840, 5860-6060-7860, 5860-8860, 6060F-6060L-6060V, 6070-6870-7870-8870, 6500-7500-8500, 6550-7550-8550, 6880-6880VM, 7530F-7530L-8830, 7880, ADVANTAGE 55F-55FP-55GE, ADVANTAGE 55GT-55GTP-55LP-55V, ADVANTAGE 60F-60FP-60GE-60GT, ADVANTAGE 60GTP-60L-60LP, ADVANTAGE 75F-75FP-75GE-75GT, ADVANTAGE 75GTP-75L-75LP-75V, ADVANTAGE 85F-85FP-85GE-85GT, ADVANTAGE 85GTP-85L-85LP, ATLAS 80 - 85 - 90 - 100, ATLATINS 80 - 85 - 90 - 100, BLIZZARD 50 - 60 - 75 - 85, CINGOLATI C4830-C5830, CINGOLATI C6830-C7830, GHIBLI 80 - 90 - 100, GHIBLI 85 - 95 - 105, POWERFARM 60, POWERFARM 75 - 85 - 95 - 105, REX 80FP - 80GE - 80GTP, REX CAB 60, TREKKER 65F, TREKKER CF55 - CF60 - CF75</p>	<p>1424135M94, 3540480M91, 3540480M92</p>	
<b>LUK500045900</b>	Cuscinetto reggispinta 90 x 50 x 21,60 mm / Thrust Bearing 90 x 50 x 21,60 mm	<b>LANDINI</b>	<p>4530V,5530F,5530L,5530V,5830, 5500,6500,7500,8500,5860,6060, 5840,6040,6840,6550,7550,8550, 6030,6030F,6030L,6030V,6530F, 6060F/L/V,6860,7860,5860,6860, 6530L,6530V,6830,7530F,7530L, 6870,7870,8870,6880,7880,8880, 7830,8530F,8530L,8830, 7860,8860,5865,6865,7860,8865, 9880,C4830,C5830,C6830,C7830, GHIBLI 80/90/100, GHIBLI TIER2 85/95/105, GLOBALFARM 90/95/100/105, GLOBUS 55, POWERFARM 60/75/85/95/105, REX 100FP/GE/GTP, REX 60FP/GE/LP, REX 60V/65V/70V/80V, REX 70/FP/GE/GTP/LP, REX 80FP/GE/GTP/LP, REX 90FP/GE/GTP, REX CAB 60/70/80/90/100, REX TIER2 105F/GE/GT/, REX TIER2 60F/GE, REX TIER2 70F/GE, REX TIER2 75F/GE/GT, REX TIER2 80F/GE, REX TIER2 85F/GE/GT, REX TIER2 90GT, REX TIER2 95F/GE/GT, TREKKER 100C, TREKKER 105C/F/M, TREKKER 70C/F/L, TREKKER 75C/F/M, TREKKER 80C/F/L, TREKKER 85C/F/M, TREKKER 90C/F/L, TREKKER 95C/F/M, TREKKER CF60/CF70, VIGNETTI 55V, VIGNETTI 60V/65V/70V/80V, VIGNETTI 75V</p>	<p>1423473M91, 1423473M93, 1423473M94, 391347X1</p>	
<b>LUK500110710</b>	Cuscinetto pto 100 x 65 x 11 mm / Pto Bearing 100 x 65 x 11 mm		<p>4530V, 5500,6500,5860,6060,6060F/L/V, 5530F/L/V,5830,6030F/L/V, 5840,6040,6840,6550,7550,8550, 6530F/L/V,6830,7530L,8830, 6870,7870,8870, 6880, 7500, 7550, 7830, 7860, 7870, 8500, 8550, 8830, 8860, 8870, ADVANTAGE 75F/FP/GE/GT/GTP/L, ADVANTAGE 75LP/V, ADVANTAGE 85F/FP/GE/GT/GTP/L, ATLANTIS 100/80/85/90, ATLAS: 100, ATLAS: 80, ATLAS: 85, ATLAS: 90, BLIZZARD 65, BLIZZARD: 75, BLIZZARD: 85, C4830,C5830,C6830,C7830, CINGOLATI:8860, CINGOLATI:C7800, FRUTTETI 530 F/L/V:7530, FRUTTETI 530 F/L/V:8530, FRUTTETI 560 F/L/V:7560, FRUTTETI 560 F/L/V:8560, GHIBLI 100/80/90, GHIBLI TIER2 105/85/95, POWER FARM: 75, POWER FARM: 85, POWERFARM 105/60/95, REX CAB E F.S: 80, REX NEW TIER 2: 75, REX NEW TIER 2: 85, TREKKER NEW TIER 2: 75, TREKKER NEW TIER 2: 85, TREKKER NEW: 70 C/F/L, TREKKER NEW: 80 C/F/L, TREKKER: CF70, TREKKER: CF75, VIGNETTI CAB E F.S: 75V</p>	<p>1442381X1</p>	
<b>LUK410004210</b>	Cuscinetto volano 47 x 20 x 14 mm - Bearing 47 x 20 x 14 mm		<p>4530V, 5500,6500,5860,6060,6060F/L/V, 5530F/L/V,5830,6030F/L/V, 5840,6040,6840,6550,7550,8550, 6530F/L/V,6830,7530L,8830, 6870,7870,8870, 6880, 7500, 7550, 7830, 7860, 7870, 8500, 8550, 8830, 8860, 8870, ADVANTAGE 75F/FP/GE/GT/GTP/L, ADVANTAGE 75LP/V, ADVANTAGE 85F/FP/GE/GT/GTP/L, ATLANTIS 100/80/85/90, ATLAS: 100, ATLAS: 80, ATLAS: 85, ATLAS: 90, BLIZZARD 65, BLIZZARD: 75, BLIZZARD: 85, C4830,C5830,C6830,C7830, CINGOLATI:8860, CINGOLATI:C7800, FRUTTETI 530 F/L/V:7530, FRUTTETI 530 F/L/V:8530, FRUTTETI 560 F/L/V:7560, FRUTTETI 560 F/L/V:8560, GHIBLI 100/80/90, GHIBLI TIER2 105/85/95, POWER FARM: 75, POWER FARM: 85, POWERFARM 105/60/95, REX CAB E F.S: 80, REX NEW TIER 2: 75, REX NEW TIER 2: 85, TREKKER NEW TIER 2: 75, TREKKER NEW TIER 2: 85, TREKKER NEW: 70 C/F/L, TREKKER NEW: 80 C/F/L, TREKKER: CF70, TREKKER: CF75, VIGNETTI CAB E F.S: 75V</p>	<p>339599X1</p>	

**KIT FRIZIONE ADATTABILE RIF. 631064210 LANDINI**

KIT EMBRAYAGE ADAPTABLE REF. 631064210 LANDINI





KIT CLUTCH ADAPTABLE REF. 631064210 LANDINI

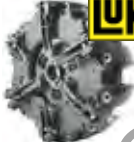

KIT KUPPLUNG PASSEND ZU REF. 631064210 LANDINI

KIT EMBRAGUE ADAPTABLE REF. 631064210 LANDINI

Art./Ref.	Note/Note	Brand	Applicazione/Application	Rif. Orig./Orig. Ref.	Immagine/Image
<b>83941</b>	Kit composto da - Kit consists of: - Meccanismo/Clutch Ref. 3540478M92 With box Original LANDINI - Disco Pto/Disc Pto Ref. 3105233M92 Not Original - Cuscinetto/Bearing Ref. 1423473M94 Not Original - Cuscinetto/Bearing Ref. 1442381X1 Not Original		6560V-6860-7560-7860-7860HC, 6870-7870-8870, 6880-6880VM-7880-7880VM, 8860-8860HC-9060, 8880-8880HC-8880VM, 9080-9080HC-9880-9880HC, ADVANTAGE 65F-65FP-65GE-65GT, ADVANTAGE 65GTP-65L-65LP-65V, ADVANTAGE 75F-75FP-75GE-75GT, ADVANTAGE 75GTP-75L-75LP-75V, ADVANTAGE 85F-85FP-85GTP-85L, ADVANTAGE 85LP-85V-95GT-95GTP, ATLAS 70-75-80-85-90-100, BLIZZARD 65-75-85-95, GHIBLI 80-90-100, GHIBLI TIER 2 85-95-105, GLOBALFARM 90-95-100-105, POWERFARM MECC TIER 2 75-85, POWERFARM MECC TIER 2 95-105, REX 100FP-100GE-100GTP, REX 100V-70V-80V-85V-90V, REX 105F-105GE-105GT, REX 70FP-70GE-70GTP-70LP, REX 75F-75GE-75GT, REX 80FP-80GE-80GTP, REX 85F-85GE-85GT, REX 90FP-90GE-90GTP, REX 95F-95GE-95GT, REX CAB 70-80-90-100, TREKKER 100C-70C-70F-70L, TREKKER 65F-75F, TREKKER 80C-80F-80L-90C-90L, TREKKER C75-C85-C95, TREKKER TIER 2 105C-105F-105M, TREKKER TIER 2 85C-85F-85M, TREKKER TIER 2 95C-95F-95M, TREKKER TIER 3 100-100F-105, TREKKER TIER 3 70-75-80-85, TREKKER TIER 3 90-95, VIGNETI 65V-75V, VIGNETI FOOTSTEP 65V-75V, VIGNETI REX CAB 70V-80V, VIGNETI REX CAB TIER 2 85V		
<b>LN3540478M92</b>	Meccanismo Frizione 12" - Landini originale	<b>LANDINI</b>	6560V-6860-7560-7860-7860HC, 6870-7870-8870, 6880-6880VM-7880-7880VM, 8860-8860HC-9060, 8880-8880HC-8880VM, 9080-9080HC-9880-9880HC, ADVANTAGE 65F-65FP-65GE-65GT, ADVANTAGE 65GTP-65L-65LP-65V, ADVANTAGE 75F-75FP-75GE-75GT, ADVANTAGE 75GTP-75L-75LP-75V, ADVANTAGE 85F-85FP-85GTP-85L, ADVANTAGE 85LP-85V-95GT-95GTP, ATLAS 70-75-80-85-90-100, BLIZZARD 65-75-85-95, GHIBLI 80-90-100, GHIBLI TIER 2 85-95-105, GLOBALFARM 90-95-100-105, POWERFARM MECC TIER 2 75-85, POWERFARM MECC TIER 2 95-105, REX 100FP-100GE-100GTP, REX 100V-70V-80V-85V-90V, REX 105F-105GE-105GT, REX 70FP-70GE-70GTP-70LP, REX 75F-75GE-75GT, REX 80FP-80GE-80GTP, REX 85F-85GE-85GT, REX 90FP-90GE-90GTP, REX 95F-95GE-95GT, REX CAB 70-80-90-100, TREKKER 100C-70C-70F-70L, TREKKER 65F-75F, TREKKER 80C-80F-80L-90C-90L, TREKKER C75-C85-C95, TREKKER TIER 2 105C-105F-105M, TREKKER TIER 2 85C-85F-85M, TREKKER TIER 2 95C-95F-95M, TREKKER TIER 3 100-100F-105, TREKKER TIER 3 70-75-80-85, TREKKER TIER 3 90-95, VIGNETI 65V-75V, VIGNETI FOOTSTEP 65V-75V, VIGNETI REX CAB 70V-80V, VIGNETI REX CAB TIER 2 85V	3540478M92, 6521050M91	
<b>07905</b>	Disco Pto Diametro 310 mm - Pto Disc Diameter 310 mm		6860, 6870, 6880, 7860, 7870, 7880, 8860, 8870, 8880, 9060, 9080, 9880, ADVANTAGE CAB E F.S: 65, ADVANTAGE CAB E F.S: 75, ADVANTAGE CAB E F.S: 85, ADVANTAGE CAB E F.S: 95, ATLAS: 100, ATLAS: 70, ATLAS: 75, ATLAS: 80, ATLAS: 85, ATLAS: 90, BLIZZARD: 65, BLIZZARD: 75, BLIZZARD: 85, BLIZZARD: 95, GHIBLI NEW TIER 2: 105, GHIBLI NEW TIER 2: 85, GHIBLI NEW TIER 2: 95, GHIBLI: 100, GHIBLI: 80, GHIBLI: 90, POWER FARM: 105, POWER FARM: 75, POWER FARM: 85, POWER FARM: 95, REX CAB E F.S: 100, REX CAB E F.S: 70, REX CAB E F.S: 80, REX CAB E F.S: 90, REX TIER 2 FP/CAB: 105, REX TIER 2 FP/CAB: 75, REX TIER 2 FP/CAB: 85, REX TIER 2 FP/CAB: 95, SERIE 60 NEW: 7860, SERIE 60 NEW: 8860, TREKKER NEW TIER 2: 105, TREKKER NEW TIER 2: 85, TREKKER NEW TIER 2: 95, TREKKER NEW: 100C, TREKKER NEW: 70 C/F/L, TREKKER NEW: 80 C/F/L, TREKKER NEW: 90 C/F/L, TREKKER: C75, TREKKER: C85, TREKKER: C95, VIGNETI CAB E F.S: 65V, VIGNETI CAB E F.S: 75V, VIGNETI REX CAB TIER 2: 85V, VIGNETI REX CAB: 70V, VIGNETI REX CAB: 80V	3105233M91, 3105233M92, 3311352M92	
<b>12841</b>	Cuscinetto reggisinta 90 x 50 x 21,60 mm / Thrust Bearing 90 x 50 x 21,60 mm		4530V,5530F,5530L,5530V,5830, 5500,6500,7500,8500,5860,6060, 5840,6040,6840,6550,7550,8550, 6030,6030F,6030L,6030V,6530F, 6060F/L/V,6860,7860,5860,6860, 6530L,6530V,6830,7530F,7530L, 6870,7870,8870,6880,7880,8880, 7830,8530F,8530L,8830, 7860,8860,5865,6865,7860,8865, 9880,C4830,C5830,C6830,C7830, GHIBLI 80/90/100, GHIBLI TIER2 85/95/105, GLOBALFARM 90/95/100/105, GLOBUS 55, POWERFARM 60/75/85/95/105, REX 100FP/GE/GTP, REX 60FP/GE/LP, REX 60V/65V/70V/80V, REX 70/FP/GE/GTP/LP, REX 80FP/GE/GTP/LP, REX 90FP/GE/GTP, REX CAB 60/70/80/90/100, REX TIER2 105F/GE/GT, REX TIER2 60F/GE, REX TIER2 70F/GE, REX TIER2 75F/GE/GT, REX TIER2 80F/GE, REX TIER2 85F/GE/GT, REX TIER2 90GT, REX TIER2 95F/GE/GT, TREKKER 100C, TREKKER 105C/F/M, TREKKER 70C/F/L, TREKKER 75C/F/M, TREKKER 80C/F/L, TREKKER 85C/F/M, TREKKER 90C/F/L, TREKKER 95C/F/M, TREKKER CF60/CF70, VIGNETI 55V, VIGNETI 60V/65V/70V/80V, VIGNETI 75V	1423473M91, 1423473M93, 1423473M94, 391347X1	



Art./Ref.	Note/Note	Brand	Applicazione/Application	Rif. Orig./Orig. Ref.	Immagine/Image
15757	Cuscinetto pto 100 x 65 x 11 mm / Pto Bearing 100 x 65 x 11 mm	LANDINI	5500, 5830, 5840, 5860, 5860 (DAL P50187, 5870, 5870 (DAL P50187), 6030, 6040, 6060, 6060(DAL P50187), 6070, 6070 (DAL P50187), 6840, 6870, 6880, 7500, 7550, 7830, 7860, 7870, 7880, 8500, 8550, 8830, 8860, 8870, 8880, 9060, 9080, 9880, ADVANTAGE CAB E F.S:55, ADVANTAGE CAB E F.S:60, ADVANTAGE CAB E F.S:65, ADVANTAGE CAB E F.S:85, ADVANTAGE CAB E F.S:95, ATLANTIS 100,70,75,80,85,90, ATLAS:100, ATLAS:70, ATLAS:75, ATLAS:80, ATLAS:85, ATLAS:90, BLIZZARD:50, BLIZZARD:60, BLIZZARD:65, BLIZZARD:75, BLIZZARD:85, BLIZZARD:95, CINGOLATI: CF6030, CINGOLATI:8860, CINGOLATI:C4500, CINGOLATI:C6500, CINGOLATI:C6830, CINGOLATI:C7800, CINGOLATI:CF5030, CINGOLATI:CF6830, FRUTTETI 530 F/L/V:4530, FRUTTETI 530 F/L/V:5530, FRUTTETI 530 F/L/V:6030, FRUTTETI 530 F/L/V:6530, FRUTTETI 530 F/L/V:7530, FRUTTETI 530 F/L/V:8530, FRUTTETI 560 F/L/V:5560, FRUTTETI 560 F/L/V:5560V/L, FRUTTETI 560 F/L/V:6060, FRUTTETI 560 F/L/V:6060V/L, FRUTTETI 560 F/L/V:6560, FRUTTETI 560 F/L/V:7560, FRUTTETI 560 F/L/V:8560, GHIBLI NEW TIER 2:105, GHIBLI NEW TIER 2:85, GHIBLI NEW TIER 2:95, GHIBLI: 80, GHIBLI:90, POWER FARM:105, POWER FARM:60, POWER FARM:75, POWER FARM:85, POWER FARM:95, REX CAB E FOOT STEP: 100, REX CAB E FOOT STEP: 70, REX CAB E FOOT STEP: 80, REX CAB E FOOT STEP: 90, REX CAB E FOOT STEP:60, REX CAB E FOOT STEP:70, REX CAB E FOOT STEP:80, REX CAB E FOOT STEP:80, REX NEW TIER 2:60, REX NEW TIER 2:75, REX NEW TIER 2:85, REX TIER 2 FP/CAB:105, REX TIER 2 FP/CAB:75, REX TIER 2 FP/CAB:85, REX TIER 2 FP/CAB:95, SERIE 60 NEW :6860, SERIE 60 NEW:5860, SERIE 60 NEW:7860, SERIE 60 NEW:8860, TREKKER :CF70, TREKKER :CF75, TREKKER COMPACT TIER 2:CF60, TREKKER COMPACT TIER 2:CF70, TREKKER NEW TIER 2:105, TREKKER NEW TIER 2:75, TREKKER NEW TIER 2:85, TREKKER NEW TIER 2:95, TREKKER NEW:100C, TREKKER NEW:70 C/F/L, TREKKER NEW:70C/F/L, TREKKER NEW:80 C/F/L, TREKKER NEW:80C/F/L, TREKKER NEW:90 C/F/L, TREKKER:C75, TREKKER:C85, TREKKER:C95, VIGNETI CAB E FOOT STEP :65V, VIGNETI CAB E FOOT STEP :75V, VIGNETI CAB E FOOT STEP:65V, VIGNETI CAB E FOOT STEP:75V, VIGNETI REX CAB :65V., VIGNETI REX CAB TIER 2 :75V, VIGNETI REX CAB TIER 2:85V, VIGNETI REX CAB:70V, VIGNETI REX CAB:80V	1442381X1	
85028	Kit composto da - Kit consists of: - Meccanismo/Clutch Ref. 3540478M92 With box Original LUK - Disco Pto/Disc Pto Ref. 3105233M92 Not Original - Cuscinetto/Bearing Ref. 1423473M94 Not Original - Cuscinetto/Bearing Ref. 1442381X1 Not Original	LANDINI	6560V-6860-7560-7860-7860HC, 6870-7870-8870, 6880-6880VM-7880-7880VM, 8860-8860HC-9060, 8880-8880HC-8880VM, 9080-9080HC-9880-9880HC, ADVANTAGE 65F-65FP-65GE-65GT, ADVANTAGE 65GTP-65L-65LP-65V, ADVANTAGE 75F-75FP-75GE-75GT, ADVANTAGE 75GTP-75L-75LP-75V, ADVANTAGE 85F-85FP-85GTP-85L, ADVANTAGE 85LP-85V-95GT-95GTP, ATLAS 70-75-80-85-90-100, BLIZZARD 65-75-85-95, GHIBLI 80-90-100, GHIBLI TIER 2 85-95-105, GLOBALFARM 90-95-100-105, POWERFARM MECC TIER 2 75-85, POWERFARM MECC TIER 2 95-105, REX 100FP-100GE-100GTP, REX 100V-70V-80V-85V-90V, REX 105F-105GE-105GT, REX 70FP-70GE-70GTP-70LP, REX 75F-75GE-75GT, REX 80FP-80GE-80GTP, REX 85F-85GE-85GT, REX 90FP-90GE-90GTP, REX 95F-95GE-95GT, REX CAB 70-80-90-100, TREKKER 100C-70C-70F-70L, TREKKER 65F-75F, TREKKER 80C-80F-80L-90C-90L, TREKKER C75-C85-C95, TREKKER TIER 2 105C-105F-105M, TREKKER TIER 2 85C-85F-85M, TREKKER TIER 2 95C-95F-95M, TREKKER TIER 3 100-100F-100M, TREKKER TIER 3 70-75-80-85, TREKKER TIER 3 90-95, VIGNETI 65V-75V, VIGNETI FOOTSTEP 65V-75V, VIGNETI REX CAB 70V-80V, VIGNETI REX CAB TIER 2 85V	3540478M92, 6521050M91	   
07903	Meccanismo Frizione 12" - Luk originale	LANDINI	6560V, 6860, 6870, 6880, 7560, 7860, 7870, 7880, 8860, 8870, 8880, 9060, 9080, 9880, ADVANTAGE CAB E F.S: 65, ADVANTAGE CAB E F.S: 75, ADVANTAGE CAB E F.S: 85, ADVANTAGE CAB E F.S: 95, ATLAS: 100, ATLAS: 70, ATLAS: 75, ATLAS: 80, ATLAS: 85, ATLAS: 90, BLIZZARD: 65, BLIZZARD: 75, BLIZZARD: 85, BLIZZARD: 95, GHIBLI NEW TIER 2: 105, GHIBLI NEW TIER 2: 85, GHIBLI NEW TIER 2: 95, GHIBLI: 100, GHIBLI: 80, GHIBLI: 90, GLOBALFARM: 100, GLOBALFARM: 105, GLOBALFARM: 90, GLOBALFARM: 95, POWER FARM: 105, POWER FARM: 75, POWER FARM: 85, POWER FARM: 95, REX 70V-80V-85V-90V-100V, REX CAB E F.S: 100, REX CAB E F.S: 70, REX CAB E F.S: 80, REX CAB E F.S: 90, REX TIER 2 FP/CAB: 105, REX TIER 2 FP/CAB: 75, REX TIER 2 FP/CAB: 85, REX TIER 2 FP/CAB: 95, REX: 100FP-100GE-100GTP, REX: 70FP-70GE-70GTP-70LP, REX: 80FP-80GE-80GTP-80LP, REX: 90FP-90GE-90GTP-90LP, SERIE 60 NEW: 7860, SERIE 60 NEW: 8860, TREKKER NEW TIER 2: 105, TREKKER NEW TIER 2: 85, TREKKER NEW TIER 2: 95, TREKKER NEW TIER 3: 100, TREKKER NEW TIER 3: 105, TREKKER NEW TIER 3: 70, TREKKER NEW TIER 3: 75, TREKKER NEW TIER 3: 80, TREKKER NEW TIER 3: 85, TREKKER NEW TIER 3: 90, TREKKER NEW TIER 3: 95, TREKKER NEW: 100C, TREKKER NEW: 70 C/F/L, TREKKER NEW: 80 C/F/L, TREKKER NEW: 90 C/F/L, TREKKER: 65F, TREKKER: 75F, TREKKER: C75, TREKKER: C85, TREKKER: C95, VIGNETI CAB E F.S: 65V, VIGNETI CAB E F.S: 75V, VIGNETI REX CAB TIER 2: 85V, VIGNETI REX CAB: 70V, VIGNETI REX CAB: 80V	3540478M91, 3540478M92, 6521050M91	

Art./Ref.	Note/Note	Brand	Applicazione/Application	Rif. Orig./Orig. Ref.	Immagine/Image
<b>07905</b>	Disco Pto Diametro 310 mm - Pto Disc Diameter 310 mm		6860, 6870, 6880, 7860, 7870, 7880, 8860, 8870, 8880, 9060, 9080, 9880, ADVANTAGE CAB E.F.S: 65, ADVANTAGE CAB E.F.S: 75, ADVANTAGE CAB E.F.S: 85, ADVANTAGE CAB E.F.S: 95, ATLAS: 100, ATLAS: 70, ATLAS: 75, ATLAS: 80, ATLAS: 85, ATLAS: 90, BLIZZARD: 65, BLIZZARD: 75, BLIZZARD: 85, BLIZZARD: 95, GIBLI NEW TIER 2: 105, GIBLI NEW TIER 2: 85, GIBLI NEW TIER 2: 95, GIBLI: 100, GIBLI: 80, GIBLI: 90, POWER FARM: 105, POWER FARM: 75, POWER FARM: 85, POWER FARM: 95, REX CAB E.F.S: 100, REX CAB E.F.S: 70, REX CAB E.F.S: 80, REX CAB E.F.S: 90, REX TIER 2 FP/CAB: 105, REX TIER 2 FP/CAB: 75, REX TIER 2 FP/CAB: 85, REX TIER 2 FP/CAB: 95, SERIE 60 NEW: 7860, SERIE 60 NEW: 8860, TREKKER NEW TIER 2: 105, TREKKER NEW TIER 2: 85, TREKKER NEW TIER 2: 95, TREKKER NEW: 100C, TREKKER NEW: 70 C/F/L, TREKKER NEW: 80 C/F/L, TREKKER NEW: 90 C/F/L, TREKKER: C75, TREKKER: C85, TREKKER: C95, VIGNETI CAB E.F.S: 65V, VIGNETI CAB E.F.S: 75V, VIGNETI REX CAB TIER 2: 85V, VIGNETI REX CAB: 70V, VIGNETI REX CAB: 80V	3105233M91, 3105233M92, 3311352M92	
<b>12841</b>	Cuscinetto reggispinta 90 x 50 x 21,60 mm / Thrust Bearing 90 x 50 x 21,60 mm	<b>LANDINI</b>	4530V,5530F,5530L,5530V,5830, 5500,6500,7500,8500,5860,6060, 5840,6040,6840,6550,7550,8550, 6030,6030F,6030L,6030V,6530F, 6060F/L/V,6860,7860,5860,6860, 6530L,6530V,6830,7530F,7530L, 6870,7870,8870,6880,7880,8880, 7830,8530F,8530L,8830, 7860,8860,8865,6865,7860,8865, 9880,C4830,C5830,C6830,C7830, GIBLI 80/90/100, GIBLI TIER2 85/95/105, GLOBALFARM 90/95/100/105, GLOBUS 55, POWERFARM 60/75/85/95/105, REX 100FP/GE/GTP, REX 60FP/GE/LP, REX 60V/65V/70V/80V, REX 70/FP/GE/GTP/LP, REX 80FP/GE/GTP/LP, REX 90FP/GE/GTP, REX CAB 60/70/80/90/100, REX TIER2 105F/GE/GT, REX TIER2 60F/GE, REX TIER2 70F/GE, REX TIER2 75F/GE/GT, REX TIER2 80F/GE, REX TIER2 85F/GE/GT, REX TIER2 90GT, REX TIER2 95F/GE/GT, TREKKER 100C, TREKKER 105C/F/M, TREKKER 70C/F/L, TREKKER 75C/F/M, TREKKER 80C/F/L, TREKKER 85C/F/M, TREKKER 90C/F/L, TREKKER 95C/F/M, TREKKER CF60/CF70, VIGNETI 55V, VIGNETI 60V/65V/70V/80V, VIGNETI 75V	1423473M91, 1423473M93, 1423473M94, 391347X1	
<b>15757</b>	Cuscinetto pto 100 x 65 x 11 mm / Pto Bearing 100 x 65 x 11 mm		5500, 5830, 5840, 5860, 5860 (DAL P50187), 5870, 5870 (DAL P50187), 6030, 6040, 6060, 6060(DAL P50187), 6070, 6070 (DAL P50187), 6840, 6870, 6880, 7500, 7550, 7830, 7860, 7870, 7880, 8500, 8550, 8830, 8860, 8870, 8880, 9060, 9080, 9880, ADVANTAGE CAB E.F.S:55, ADVANTAGE CAB E.F.S:60, ADVANTAGE CAB E.F.S:65, ADVANTAGE CAB E.F.S:85, ADVANTAGE CAB E.F.S:95, ATLANTIS 100,70,75,80,85,90, ATLAS:100, ATLAS:70, ATLAS:75, ATLAS:80, ATLAS:85, ATLAS:90, BLIZZARD:50, BLIZZARD:60, BLIZZARD:65, BLIZZARD:75, BLIZZARD:85, BLIZZARD:95, CINGOLATI: CF6030, CINGOLATI:8860, CINGOLATI:C4500, CINGOLATI:C6500, CINGOLATI:C6830, CINGOLATI:C7800, CINGOLATI:CF5030, CINGOLATI:CF6830, FRUTTETI 530 F/L/V:4530, FRUTTETI 530 F/L/V:5530, FRUTTETI 530 F/L/V:6030, FRUTTETI 530 F/L/V:6530, FRUTTETI 530 F/L/V:7530, FRUTTETI 530 F/L/V:8530, FRUTTETI 560 F/L/V:5560, FRUTTETI 560 F/L/V:5560V/L, FRUTTETI 560 F/L/V:6060, FRUTTETI 560 F/L/V:6060V/L, FRUTTETI 560 F/L/V:6560, FRUTTETI 560 F/L/V:7560, FRUTTETI 560 F/L/V:8560, GIBLI NEW TIER 2:105, GIBLI NEW TIER 2:85, GIBLI NEW TIER 2:95, GIBLI: 80, GIBLI:90, POWER FARM:105, POWER FARM:60, POWER FARM:75, POWER FARM:85, POWER FARM:95, REX CAB E FOOT STEP: 100, REX CAB E FOOT STEP: 70, REX CAB E FOOT STEP: 80, REX CAB E FOOT STEP: 90, REX CAB E FOOT STEP:60, REX CAB E FOOT STEP:70, REX CAB E FOOT STEP:80, REX CAB E FOOT STEP:80, REX NEW TIER 2:60, REX NEW TIER 2:75, REX NEW TIER 2:85, REX TIER 2 FP/CAB:105, REX TIER 2 FP/CAB:75, REX TIER 2 FP/CAB:85, REX TIER 2 FP/CAB:95, SERIE 60 NEW :6860, SERIE 60 NEW:5860, SERIE 60 NEW:7860, SERIE 60 NEW:8860, TREKKER :CF70, TREKKER :CF75, TREKKER COMPACT TIER 2:CF60, TREKKER COMPACT TIER 2:CF70, TREKKER NEW TIER 2:105, TREKKER NEW TIER 2:75, TREKKER NEW TIER 2:85, TREKKER NEW TIER 2:95, TREKKER NEW:100C, TREKKER NEW:70 C/F/L, TREKKER NEW:70C/F/L, TREKKER NEW:80 C/F/L, TREKKER NEW:80C/F/L, TREKKER NEW:90 C/F/L, TREKKER:C75, TREKKER:C85, TREKKER:C95, VIGNETI CAB E FOOT STEP :65V, VIGNETI CAB E FOOT STEP :75V, VIGNETI CAB E FOOT STEP:65V, VIGNETI CAB E FOOT STEP:75V, VIGNETI REX CAB :65V, VIGNETI REX CAB TIER 2 :75V, VIGNETI REX CAB TIER 2:85V, VIGNETI REX CAB:70V, VIGNETI REX CAB:80V	1442381X1	

Art./Ref.	Note/Note	Brand	Applicazione/Application	Rif. Orig./Orig. Ref.	Immagine/Image
<b>LUK631064210</b>	<p>Kit tutto originale LUK composto da - Kit all LUK original consists of:</p> <ul style="list-style-type: none"> <li>- Meccanismo/Clutch Ref. 231 0046 11</li> <li>- Disco Pto/Disc Pto 331 0134 16</li> <li>- Cuscinetto/Bearing Ref. 500 1159 10</li> <li>- Cuscinetto/Bearing Ref. 500 1107 10</li> <li>- Cuscinetto/Bearing Ref. 410 0042 10</li> </ul>		<p>6560V-6860-7560-7860-7860HC, 6870-7870-8870, 6880-6880VM-7880-7880VM, 8860-8860HC-9060, 8880-8880HC-8880VM, 9080-9080HC-9880-9880HC, ADVANTAGE 65F-65FP-65GE-65GT, ADVANTAGE 65GTP-65L-65LP-65V, ADVANTAGE 75F-75FP-75GE-75GT, ADVANTAGE 75GTP-75L-75LP-75V, ADVANTAGE 85F-85FP-85GTP-85L, ADVANTAGE 85LP-85V-95GT-95GTP, ATLAS 70-75-80-85-90-100, BLIZZARD 65-75-85-95, GHIBLI 80-90-100, GHIBLI TIER 2 85-95-105, GLOBALFARM 90-95-100-105, POWERFARM MECC TIER 2 75-85, POWERFARM MECC TIER 2 95-105, REX 100FP-100GE-100GTP, REX 100V-70V-80V-85V-90V, REX 105F-105GE-105GT, REX 70FP-70GE-70GTP-70LP, REX 75F-75GE-75GT, REX 80FP-80GE-80GTP, REX 85F-85GE-85GT, REX 90FP-90GE-90GTP, REX 95F-95GE-95GT, REX CAB 70-80-90-100, TREKKER 100C-70C-70F-70L, TREKKER 65F-75F, TREKKER 80C-80F-80L-90C-90L, TREKKER C75-C85-C95, TREKKER TIER 2 105C-105F-105M, TREKKER TIER 2 85C-85F-85M, TREKKER TIER 2 95C-95F-95M, TREKKER TIER 3 100-100F-105, TREKKER TIER 3 70-75-80-85, TREKKER TIER 3 90-95, VIGNETI 65V-75V, VIGNETI FOOTSTEP 65V-75V, VIGNETI REX CAB 70V-80V, VIGNETI REX CAB TIER 2 85V</p>	<p>1423473M94, 1442381X1, 3105233M92, 339599X1, 3540478M92, 6521050M91</p>	
<b>LUK631064216</b>	<p>Kit tutto originale LUK composto da - Kit all LUK original consists of:</p> <ul style="list-style-type: none"> <li>- Meccanismo/Clutch Ref. 231 0046 11</li> <li>- Disco Pto/Disc Pto 331 0134 16</li> </ul>		<p>6860, 6870, 6880, 7860, 7870, 7880, 8860, 8870, 8880, 9060, 9080, 9880, ADVANTAGE CAB E F.S.:65, ADVANTAGE CAB E F.S.:75, ADVANTAGE CAB E F.S.:85, ADVANTAGE CAB E F.S.:95, ATLAS:100, ATLAS:70, ATLAS:75, ATLAS:80, ATLAS:85, ATLAS:90, BLIZZARD:65, BLIZZARD:75, BLIZZARD:85, BLIZZARD:95, GHIBLI NEW TIER 2:105, GHIBLI NEW TIER 2:85, GHIBLI NEW TIER 2:95, GHIBLI: 100, GHIBLI: 80, GHIBLI:90, POWER FARM:105, POWER FARM:75, POWER FARM:85, POWER FARM:95, REX CAB E FOOT STEP: 100, REX CAB E FOOT STEP: 70, REX CAB E FOOT STEP: 80, REX CAB E FOOT STEP: 90, REX TIER 2 FP/CAB:105, REX TIER 2 FP/CAB:75, REX TIER 2 FP/CAB:85, REX TIER 2 FP/CAB:95, SERIE 60 NEW:7860, SERIE 60 NEW:8860, TREKKER NEW TIER 2:105, TREKKER NEW TIER 2:85, TREKKER NEW TIER 2:95, TREKKER NEW:100C, TREKKER NEW:70 C/F/L, TREKKER NEW:80 C/F/L, TREKKER NEW:90 C/F/L, TREKKER:C75, TREKKER:C85, TREKKER:C95, VIGNETI CAB E FOOT STEP:65V, VIGNETI CAB E FOOT STEP:75V, VIGNETI REX CAB TIER 2:85V, VIGNETI REX CAB:70V, VIGNETI REX CAB:80V</p>	<p>3547012M93, 3547012M94, 6521049M91</p>	
<b>LUK500115910</b>	<p>Cuscinetto reggispinta 94 x 50 x 22 mm / Thrust Bearing 94 x 50 x 22 mm</p>	<b>LANDINI</b>	<p>6560V-6860-7560-7860-7860HC, 6870-7870-8870, 6880-6880VM-7880-7880VM, 8860-8860HC-9060, 8880-8880HC-8880VM, 9080-9080HC-9880-9880HC, ADVANTAGE 65F-65FP-65GE-65GT, ADVANTAGE 65GTP-65L-65LP-65V, ADVANTAGE 75F-75FP-75GE-75GT, ADVANTAGE 75GTP-75L-75LP-75V, ADVANTAGE 85F-85FP-85GTP-85L, ADVANTAGE 85LP-85V-95GT-95GTP, ATLAS 70-75-80-85-90-100, BLIZZARD 65-75-85-95, GHIBLI 80-90-100, GHIBLI TIER 2 85-95-105, GLOBALFARM 90-95-100-105, POWERFARM MECC TIER 2 75-85, POWERFARM MECC TIER 2 95-105, REX 100FP-100GE-100GTP, REX 100V-70V-80V-85V-90V, REX 105F-105GE-105GT, REX 70FP-70GE-70GTP-70LP, REX 75F-75GE-75GT, REX 80FP-80GE-80GTP, REX 85F-85GE-85GT, REX 90FP-90GE-90GTP, REX 95F-95GE-95GT, REX CAB 70-80-90-100, TREKKER 100C-70C-70F-70L, TREKKER 65F-75F, TREKKER 80C-80F-80L-90C-90L, TREKKER C75-C85-C95, TREKKER TIER 2 105C-105F-105M, TREKKER TIER 2 85C-85F-85M, TREKKER TIER 2 95C-95F-95M, TREKKER TIER 3 100-100F-105, TREKKER TIER 3 70-75-80-85, TREKKER TIER 3 90-95, VIGNETI 65V-75V, VIGNETI FOOTSTEP 65V-75V, VIGNETI REX CAB 70V-80V, VIGNETI REX CAB TIER 2 85V</p>	<p>1423473M94</p>	
<b>LUK500110710</b>	<p>Cuscinetto pto 100 x 65 x 11 mm / Pto Bearing 100 x 65 x 11 mm</p>		<p>4530V, 5500, 6500, 5860, 6060, 6060F/L/V, 5530F/L/V, 5830, 6030F/L/V, 5840, 6040, 6840, 6550, 7550, 8550, 6530F/L/V, 6830, 7530L, 8830, 6870, 7870, 8870, 6880, 7500, 7550, 7830, 7860, 7870, 8500, 8550, 8830, 8860, 8870, ADVANTAGE 75F/FP/GE/GT/GTP/L, ADVANTAGE 75LP/V, ADVANTAGE 85F/FP/GE/GT/GTP/L, ATLANTIS 100/80/85/90, ATLAS: 100, ATLAS: 80, ATLAS: 85, ATLAS: 90, BLIZZARD 65, BLIZZARD: 75, BLIZZARD: 85, C4830, C5830, C6830, C7830, CINGOLATI:8860, CINGOLATI:C7800, FRUTTETI 530 F/L/V:7530, FRUTTETI 530 F/L/V:8530, FRUTTETI 560 F/L/V:7560, FRUTTETI 560 F/L/V:8560, GHIBLI 100/80/90, GHIBLI TIER2 105/85/95, POWER FARM: 75, POWER FARM: 85, POWERFARM 105/60/95, REX CAB E F.S.: 80, REX NEW TIER 2: 75, REX NEW TIER 2: 85, TREKKER NEW TIER 2: 75, TREKKER NEW TIER 2: 85, TREKKER NEW: 70 C/F/L, TREKKER NEW: 80 C/F/L, TREKKER: CF70, TREKKER: CF75, VIGNETI CAB E F.S.: 75V</p>	<p>1442381X1</p>	
<b>LUK410004210</b>	<p>Cuscinetto volano 47 x 20 x 14 mm - Bearing 47 x 20 x 14 mm</p>		<p>4530V, 5500, 6500, 5860, 6060, 6060F/L/V, 5530F/L/V, 5830, 6030F/L/V, 5840, 6040, 6840, 6550, 7550, 8550, 6530F/L/V, 6830, 7530L, 8830, 6870, 7870, 8870, 6880, 7500, 7550, 7830, 7860, 7870, 8500, 8550, 8830, 8860, 8870, ADVANTAGE 75F/FP/GE/GT/GTP/L, ADVANTAGE 75LP/V, ADVANTAGE 85F/FP/GE/GT/GTP/L, ATLANTIS 100/80/85/90, ATLAS: 100, ATLAS: 80, ATLAS: 85, ATLAS: 90, BLIZZARD 65, BLIZZARD: 75, BLIZZARD: 85, C4830, C5830, C6830, C7830, CINGOLATI:8860, CINGOLATI:C7800, FRUTTETI 530 F/L/V:7530, FRUTTETI 530 F/L/V:8530, FRUTTETI 560 F/L/V:7560, FRUTTETI 560 F/L/V:8560, GHIBLI 100/80/90, GHIBLI TIER2 105/85/95, POWER FARM: 75, POWER FARM: 85, POWERFARM 105/60/95, REX CAB E F.S.: 80, REX NEW TIER 2: 75, REX NEW TIER 2: 85, TREKKER NEW TIER 2: 75, TREKKER NEW TIER 2: 85, TREKKER NEW: 70 C/F/L, TREKKER NEW: 80 C/F/L, TREKKER: CF70, TREKKER: CF75, VIGNETI CAB E F.S.: 75V</p>	<p>339599X1</p>	

**MECCANISMO + DISCO PTO ORIGINALE LUK RIF. 631064216**

MECANISME + DISQUE PTO ORIGINAL LUK 631064216

COVER ASSEMBLY + ORIGINAL PTO DISC LUK REF. 631064216







GETRIEBE + ZAPFWELLENSCHEIBE LUK 631064216

MECANISMO + DISCO PTO ORIGINAL LUK REF. 631064216

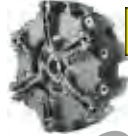
Art./Ref.	Note/Note	Brand	Applicazione/Application	Rif. Orig./Orig. Ref.	Immagine/Image
<b>LUK631064216</b>	Kit tutto originale LUK composto da - Kit all LUK original consists of: - Meccanismo/Clutch Ref. 231 0046 11 - Disco Pto/Disc Pto 331 0134 16		6860, 6870, 6880, 7860, 7870, 7880, 8860, 8870, 8880, 9060, 9080, 9880, ADVANTAGE CAB E F.S:65, ADVANTAGE CAB E F.S:75, ADVANTAGE CAB E F.S:85, ADVANTAGE CAB E F.S:95, ATLAS:100, ATLAS:70, ATLAS:75, ATLAS:80, ATLAS:85, ATLAS:90, BLIZZARD:65, BLIZZARD:75, BLIZZARD:85, BLIZZARD:95, GHIBLI NEW TIER 2:105, GHIBLI NEW TIER 2:85, GHIBLI NEW TIER 2:95, GHIBLI: 100, GHIBLI: 80, GHIBLI:90, POWER FARM:105, POWER FARM:75, POWER FARM:85, POWER FARM:95, REX CAB E FOOT STEP: 100, REX CAB E FOOT STEP: 70, REX CAB E FOOT STEP: 80, REX CAB E FOOT STEP: 90, REX TIER 2 FP/CAB:105, REX TIER 2 FP/CAB:75, REX TIER 2 FP/CAB:85, REX TIER 2 FP/CAB:95, SERIE 60 NEW:7860, SERIE 60 NEW:8860, TREKKER NEW TIER 2:105, TREKKER NEW TIER 2:85, TREKKER NEW TIER 2:95, TREKKER NEW:100C, TREKKER NEW:70 C/F/L, TREKKER NEW:80 C/F/L, TREKKER NEW:90 C/F/L, TREKKER:C75, TREKKER:C85, TREKKER:C95, VIGNETI CAB E FOOT STEP:65V, VIGNETI CAB E FOOT STEP:75V, VIGNETI REX CAB TIER 2:85V, VIGNETI REX CAB:70V, VIGNETI REX CAB:80V	3547012M93, 3547012M94, 6521049M91	
<b>LUK500115910</b>	Cuscinetto reggispira 94 x 50 x 22 mm / Thrust Bearing 94 x 50 x 22 mm	<b>LANDINI</b>	6560V-6860-7560-7860HC, 6870-7870-8870, 6880-6880VM-7880-7880VM, 8860-8860HC-9060, 8880-8880HC-8880VM, 9080-9080HC-9880-9880HC, ADVANTAGE 65F-65FP-65GE-65GT, ADVANTAGE 65GTP-65L-65LP-65V, ADVANTAGE 75F-75FP-75GE-75GT, ADVANTAGE 75GTP-75L-75LP-75V, ADVANTAGE 85F-85FP-85GTP-85L, ADVANTAGE 85LP-85V-95GT-95GTP, ATLAS 70-75-80-85-90-100, BLIZZARD 65-75-85-95, GHIBLI 80-90-100, GHIBLI TIER 2 85-95-105, GLOBALFARM 90-95-100-105, POWERFARM MECC TIER 2 75-85, POWERFARM MECC TIER 2 95-105, REX 100FP-100GE-100GTP, REX 100V-70V-80V-85V-90V, REX 105F-105GE-105GT, REX 70FP-70GE-70GTP-70LP, REX 75F-75GE-75GT, REX 80FP-80GE-80GTP, REX 85F-85GE-85GT, REX 90FP-90GE-90GTP, REX 95F-95GE-95GT, REX CAB 70-80-90-100, TREKKER 100C-70C-70F-70L, TREKKER 65F-75F, TREKKER 80C-80F-80L-90C-90L, TREKKER C75-C85-C95, TREKKER TIER 2 105C-105F-105M, TREKKER TIER 2 85C-85F-85M, TREKKER TIER 2 95C-95F-95M, TREKKER TIER 3 100-100F-105, TREKKER TIER 3 70-75-80-85, TREKKER TIER 3 90-95, VIGNETI 65V-75V, VIGNETI FOOTSTEP 65V-75V, VIGNETI REX CAB 70V-80V, VIGNETI REX CAB TIER 2 85V	1423473M94	
<b>LUK500110710</b>	Cuscinetto pto 100 x 65 x 11 mm / Pto Bearing 100 x 65 x 11 mm		4530V, 5500, 6500, 5860, 6060, 6060F/L/V, 5530F/L/V, 5830, 6030F/L/V, 5840, 6040, 6840, 6550, 7550, 8550, 6530F/L/V, 6830, 7530L, 8830, 6870, 7870, 8870, 6880, 7500, 7550, 7830, 7860, 7870, 8500, 8550, 8830, 8860, 8870, ADVANTAGE 75F/FP/GE/GT/GTP/L, ADVANTAGE 75LP/V, ADVANTAGE 85F/FP/GE/GT/GTP/L, ATLANTIS 100/80/85/90, ATLAS: 100, ATLAS: 80, ATLAS: 85, ATLAS: 90, BLIZZARD 65, BLIZZARD: 75, BLIZZARD: 85, C4830, C5830, C6830, C7830, CINGOLATI:8860, CINGOLATI:C7800, FRUTTETI 530 F/L/V:7530, FRUTTETI 530 F/L/V:8530, FRUTTETI 560 F/L/V:7560, FRUTTETI 560 F/L/V:8560, GHIBLI 100/80/90, GHIBLI TIER2 105/85/95, POWER FARM: 75, POWER FARM: 85, POWERFARM 105/60/95, REX CAB E F.S: 80, REX NEW TIER 2: 75, REX NEW TIER 2: 85, TREKKER NEW TIER 2: 75, TREKKER NEW TIER 2: 85, TREKKER NEW: 70 C/F/L, TREKKER NEW: 80 C/F/L, TREKKER: CF70, TREKKER: CF75, VIGNETI CAB E F.S: 75V	1442381X1	
<b>LUK410004210</b>	Cuscinetto volano 47 x 20 x 14 mm - Bearing 47 x 20 x 14 mm		4530V, 5500, 6500, 5860, 6060, 6060F/L/V, 5530F/L/V, 5830, 6030F/L/V, 5840, 6040, 6840, 6550, 7550, 8550, 6530F/L/V, 6830, 7530L, 8830, 6870, 7870, 8870, 6880, 7500, 7550, 7830, 7860, 7870, 8500, 8550, 8830, 8860, 8870, ADVANTAGE 75F/FP/GE/GT/GTP/L, ADVANTAGE 75LP/V, ADVANTAGE 85F/FP/GE/GT/GTP/L, ATLANTIS 100/80/85/90, ATLAS: 100, ATLAS: 80, ATLAS: 85, ATLAS: 90, BLIZZARD 65, BLIZZARD: 75, BLIZZARD: 85, C4830, C5830, C6830, C7830, CINGOLATI:8860, CINGOLATI:C7800, FRUTTETI 530 F/L/V:7530, FRUTTETI 530 F/L/V:8530, FRUTTETI 560 F/L/V:7560, FRUTTETI 560 F/L/V:8560, GHIBLI 100/80/90, GHIBLI TIER2 105/85/95, POWER FARM: 75, POWER FARM: 85, POWERFARM 105/60/95, REX CAB E F.S: 80, REX NEW TIER 2: 75, REX NEW TIER 2: 85, TREKKER NEW TIER 2: 75, TREKKER NEW TIER 2: 85, TREKKER NEW: 70 C/F/L, TREKKER NEW: 80 C/F/L, TREKKER: CF70, TREKKER: CF75, VIGNETI CAB E F.S: 75V	339599X1	

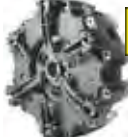

**MECCANISMO + DISCO PTO ORIGINALE LUK RIF. 633052319**

MECANISME + DISQUE PTO ORIGINAL LUK 633052319  
 COVER ASSEMBLY + ORIGINAL PTO DISC LUK REF. 633052319  
 GETRIEBE + ZAPFWELLENSCHEIBE LUK 633052319  
 MECANISMO + DISCO PTO ORIGINAL LUK REF. 633052319

Art./Ref.	Note/Note	Brand	Applicazione/Application	Rif. Orig./Orig. Ref.	Immagine/Image
<b>LUK633052319</b>	Kit tutto originale LUK composto da - Kit all LUK original consists of: - Meccanismo/Clutch Ref. 233 0020 12 - Disco Pto/Disc Pto 333 0019 16	<b>LANDINI</b>	10000, 10000S, 12500, 13000, 14500	1426390M94, 3540481M91	 
<b>07906</b>	Meccanismo Frizione 13" - Luk originale		10000, 10000S, 12500, 13000, 14500	3540481M91	
<b>07908</b>	Disco Pto Diametro 330 mm - Pto Disc Diameter 330 mm		10000, 10000S, 12500, 13000, 14500	1426390M93, 1426390M94	
<b>59850</b>	Cuscinetto reggispinta 92 x 55 x 31 mm / Thrust Bearing 92 x 55 x 31 mm		10000, 10000S(->22900804), 12500, 13000, 14500	3302143M91	
<b>70427</b>	Cuscinetto pto 115 x 75 x 13 mm / Pto Bearing 115 x 75 x 13 mm		10000, 10000S, 12500, 13000, 14500	392191X1	
<b>70433</b>	Cuscinetto volano 52 x 25 x 18 mm - Bearing 52 x 25 x 18 mm		10000, 10000S, 12500, 13000, 14500, LEGEND N/G TDI:125, LEGEND N/G TDI:135, LEGEND N/G TDI:145, LEGEND N/G-TDI :165, LEGEND N/G-TDI :185, LEGEND N/G:115, LEGEND N/G:120, LEGEND N/G:130, LEGEND N/G:140, LEGEND N/G:160, LEGEND N/G:180, LEGEND:105, LEGEND:115, LEGEND:130, LEGEND:145, LEGEND:165	392168X1	



**MECCANISMO + DISCO AVANZAMENTO ORIGINALE LUK RIF. 635211609**

MECANISME + DISQUE AVANCEMENT ORIGINAL LUK 635211609  
 COVER ASSEMBLY + ORIGINAL MAIN DRIVE LUK REF. 635211609  
 GETRIEBE + VORSCHLEIBE LUK 635211609  
 MECANISMO + DISCO DE AVANCE ORIGINAL LUK REF. 635211609

Art./Ref.	Note/Note	Brand	Applicazione/Application	Rif. Orig./Orig. Ref.	Immagine/Image
<b>70853</b>	Kit tutto originale LUK composto da - Kit all LUK original consists of: - Meccanismo/Clutch Ref. 135 0243 11 - Disco avanzamento/Disc 335 0191 10	<b>LANDINI</b>	LANDPOWER 125, LANDPOWER 135, LANDPOWER 145, LEGEND 105 TOP, LEGEND 115 TOP, LEGEND 120 TOP, LEGEND 130 TOP, LEGEND 140 TOP, LEGEND 145 TOP, LEGEND 165 TOP	3559802M91	 
<b>70433</b>	Cuscinetto volano 52 x 25 x 18 mm - Bearing 52 x 25 x 18 mm		10000, 10000S, 12500, 13000, 14500, LEGEND N/G TDI:125, LEGEND N/G TDI:135, LEGEND N/G TDI:145, LEGEND N/G-TDI :165, LEGEND N/G-TDI :185, LEGEND N/G:115, LEGEND N/G:120, LEGEND N/G:130, LEGEND N/G:140, LEGEND N/G:160, LEGEND N/G:180, LEGEND:105, LEGEND:115, LEGEND:130, LEGEND:145, LEGEND:165	392168X1	





**MECCANISMO + DISCO PTO ORIGINALE LUK RIF. 635238409**

MECANISME + DISQUE PTO ORIGINAL LUK 635238409  
 COVER ASSEMBLY + ORIGINAL PTO DISC LUK REF. 635238409  
 GETRIEBE + ZAPFWELLENSCHEIBE LUK 635238409  
 MECANISMO + DISCO PTO ORIGINAL LUK REF. 635238409

Art./Ref.	Note/Note	Brand	Applicazione/Application	Rif. Orig./Orig. Ref.	Immagine/Image
<b>70854</b>	Kit tutto originale LUK composto da - Kit all LUK original consists of: - Meccanismo/Clutch Ref. 235 0027 10 - Disco Pto/Disc Pto 335 0194 10	<b>LANDINI</b>	LANDPOWER 140, LANDPOWER 160, LANDPOWER 165, LEGEND 160 TOP, LEGEND 165 TECHNO	3559804M91	
<b>70433</b>	Cuscinetto volano 52 x 25 x 18 mm - Bearing 52 x 25 x 18 mm		10000, 10000S, 12500, 13000, 14500, LEGEND N/G TDI:125, LEGEND N/G TDI:135, LEGEND N/G TDI:145, LEGEND N/G-TDI :165, LEGEND N/G-TDI :185, LEGEND N/G:115, LEGEND N/G:120, LEGEND N/G:130, LEGEND N/G:140, LEGEND N/G:160, LEGEND N/G:180, LEGEND:105, LEGEND:115, LEGEND:130, LEGEND:145, LEGEND:165	392168X1	

**MECCANISMO + DISCO PTO ORIGINALE LUK RIF. 623306509**

MECANISME + DISQUE PTO ORIGINAL LUK 623306509  
 COVER ASSEMBLY + ORIGINAL PTO DISC LUK REF. 623306509  
 GETRIEBE + ZAPFWELLENSCHEIBE LUK 623306509  
 MECANISMO + DISCO PTO ORIGINAL LUK REF. 623306509

Art./Ref.	Note/Note	Brand	Applicazione/Application	Rif. Orig./Orig. Ref.	Immagine/Image
<b>LUK623306509</b>	Kit tutto originale LUK composto da - Kit all LUK original consists of: - Meccanismo/Clutch Ref. 223 0028 10 - Disco Pto/Disc Pto 323 0471 10	<b>LANDINI</b>	MISTRAL 40, MISTRAL 45, MISTRAL 50, MISTRAL 55	4202165M91, 6510438M91	
<b>LUK500045900</b>	Cuscinetto reggispinna 90 x 50 x 21,60 mm / Thrust Bearing 90 x 50 x 21,60 mm		4530V,5530F,5530L,5530V,5830, 5500,6500,7500,8500,5860,6060, 5840,6040,6840,6550,7550,8550, 6030,6030F,6030L,6030V,6530F, 6060F/L/V,6860,7860,5860,6860, 6530L,6530V,6830,7530F,7530L, 6870,7870,8870,6880,7880,8880, 7830,8530F,8530L,8830, 7860,8860,5865,6865,7860,8865, 9880,C4830,C5830,C6830,C7830, GHIBLI 80/90/100, GHIBLI TIER2 85/95/105, GLOBALFARM 90/95/100/105, GLOBUS 55, POWERFARM 60/75/85/95/105, REX 100FP/GE/GTP, REX 60FP/GE/LP, REX 60V/65V/70V/80V, REX 70/FP/GE/GTP/LP, REX 80FP/GE/GTP/LP, REX 90FP/GE/GTP, REX CAB 60/70/80/90/100, REX TIER2 105F/GE/GT/, REX TIER2 60F/GE, REX TIER2 70F/GE, REX TIER2 75F/GE/GT, REX TIER2 80F/GE, REX TIER2 85F/GE/GT, REX TIER2 90GT, REX TIER2 95F/GE/GT, TREKKER 100C, TREKKER 105C/F/M, TREKKER 70C/F/L, TREKKER 75C/F/M, TREKKER 80C/F/L, TREKKER 85C/F/M, TREKKER 90C/F/L, TREKKER 95C/F/M, TREKKER CF60/CF70, VIGNETI 55V, VIGNETI 60V/65V/70V/80V, VIGNETI 75V	1423473M91, 1423473M93, 1423473M94, 391347X1	
<b>LUK500067300</b>	Cuscinetto pto 100 x 65 x 18 mm / Pto Bearing 100 x 65 x 18 mm		MISTRAL 40, MISTRAL 45, MISTRAL 50, MISTRAL 55	390947X1	
<b>LUK410002400</b>	Cuscinetto volano 35 x 15 x 11 mm - Bearing 35 x 15 x 11 mm		MISTRAL 40, MISTRAL 45, MISTRAL 50, MISTRAL 55	339932X1	

**KIT FRIZIONE ADATTABILE RIF. 628052210 MCCORMICK**

KIT EMBRAYAGE ADAPTABLE REF. 628052210 MCCORMICK

KIT CLUTCH ADAPTABLE REF. 628052210 MCCORMICK

KIT KUPPLUNG PASSEND ZU REF. 628052210 MCCORMICK

KIT EMBRAGUE ADAPTABLE REF. 628052210 MCCORMICK

Art./Ref.	Note/Note	Brand	Applicazione/Application	Rif. Orig./Orig. Ref.	Immagine/Image
<b>83940</b>	Kit composto da - Kit consists of: - Meccanismo/Clutch Ref. 3540480M92 With box Original LANDINI - Disco Pto/Disc Pto Ref. 1424135M93 Not Original - Cuscinetto/Bearing Ref. 1423473M94 Not Original - Cuscinetto/Bearing Ref. 1442381X1 Not Original	<b>MCCORMICK</b>	C75MAX, C80MAX, C85MAX, CLASSIC 353, F75, F80, F85, T100, T70, T80, T90	3540480M91, 3540480M92	
<b>LN3540480M91</b>	Meccanismo Frizione 11" - Landini originale		C75MAX, C80MAX, C85MAX, CLASSIC 353, F75, F80, F85, T100, T70, T80, T90	3540480M91, 3540480M92	
<b>70467</b>	Disco Pto Diametro 280 mm - Pto Disc Diameter 280 mm		F60, F70, F75, F80, F85, T100, T70, T90, V60, V65, V70, V80	1424135M93	
<b>12841</b>	Cuscinetto reggispinta 90 x 50 x 21,60 mm / Thrust Bearing 90 x 50 x 21,60 mm		F60, F70, F75, F80, F85, T100, T70, T80, T90, V60, V65, V70, V80	1423473M93, 1966557C1	
<b>15757</b>	Cuscinetto pto 100 x 65 x 11 mm / Pto Bearing 100 x 65 x 11 mm		F90, F95, T100, T70, T80, T90, V60, V65, V70, V80	1442381X1	
<b>85025</b>	Kit composto da - Kit consists of: - Meccanismo/Clutch Ref. 3540480M92 With box Original LUK - Disco Pto/Disc Pto Ref. 1424135M93 Not Original - Cuscinetto/Bearing Ref. 1423473M94 Not Original - Cuscinetto/Bearing Ref. 1442381X1 Not Original	<b>MCCORMICK</b>	C75MAX, C80MAX, C85MAX, CLASSIC 353, F75, F80, F85, T100, T70, T80, T90	3540480M91, 3540480M92	
<b>07898</b>	Meccanismo Frizione 11" - Luk originale		353, C75MAX, C80MAX, C85MAX, F75, F80, F85, T100, T70, T80, T90	3540480M91, 3540480M92	

Art./Ref.	Note/Note	Brand	Applicazione/Application	Rif. Orig./Orig. Ref.	Immagine/Image
<b>70467</b>	Disco Pto Diametro 280 mm - Pto Disc Diameter 280 mm	<b>MCCORMICK</b>	F60,F70,F75,F80,F85, T100,T70,T90, V60,V65,V70,V80	1424135M93	
<b>12841</b>	Cuscinetto reggispinta 90 x 50 x 21,60 mm / Thrust Bearing 90 x 50 x 21,60 mm		F60,F70,F75,F80,F85, T100,T70,T80,T90, V60,V65,V70,V80	1423473M93, 1966557C1	
<b>15757</b>	Cuscinetto pto 100 x 65 x 11 mm / Pto Bearing 100 x 65 x 11 mm		F100,F105,F60,F70,F75,F80,F85, F90,F95, T100,T70,T80,T90, V60,V65,V70,V80	1442381X1	
<b>LUK628052210</b>	Kit tutto originale LUK composto da - Kit all LUK original consists of: - Meccanismo/Clutch Ref. 228 0003 14 - Disco Pto/Disc Pto 328 0083 16 - Cuscinetto/Bearing Ref. 500 0459 00 - Cuscinetto/Bearing Ref. 500 1107 10 - Cuscinetto/Bearing Ref. 410 0042 10	<b>MCCORMICK</b>	C75MAX, C80MAX, C85MAX, CLASSIC 353, F75, F80, F85, T100, T70, T80, T90	1423473M94, 1424135M94, 1442381X1, 339599X1, 3540480M91, 3540480M92	    
<b>LUK628052209</b>	Kit tutto originale LUK composto da - Kit all LUK original consists of: - Meccanismo/Clutch Ref. 228 0003 14 - Disco Pto/Disc Pto 328 0083 16		C75MAX, C80MAX, C85MAX, CLASSIC 353, F75, F80, F85, T100, T70, T80, T90	1424135M94, 3540480M91, 3540480M92	 
<b>LUK500045900</b>	Cuscinetto reggispinta 90 x 50 x 21,60 mm / Thrust Bearing 90 x 50 x 21,60 mm		F60,F70,F75,F80,F85, T100,T70,T80,T90, V60,V65,V70,V80	1423473M93, 1966557C1	
<b>LUK500110710</b>	Cuscinetto pto 100 x 65 x 11 mm / Pto Bearing 100 x 65 x 11 mm		353, C75MAX,C80MAX,C85MAX, F75,F80,F85, T100,T70,T80,T90	1442381X1	
<b>LUK410004210</b>	Cuscinetto volano 47 x 20 x 14 mm - Bearing 47 x 20 x 14 mm		353, C75MAX,C80MAX,C85MAX, F75,F80,F85, T100,T70,T80,T90	339599X1	



**KIT FRIZIONE ADATTABILE RIF. 631064210 MCCORMICK**

KIT EMBRAYAGE ADAPTABLE REF. 631064210 MCCORMICK

KIT CLUTCH ADAPTABLE REF. 631064210 MCCORMICK

KIT KUPPLUNG PASSEND ZU REF. 631064210 MCCORMICK

KIT EMBRAGUE ADAPTABLE REF. 631064210 MCCORMICK

Art./Ref.	Note/Note	Brand	Applicazione/Application	Rif. Orig./Orig. Ref.	Immagine/Image
83941	<p>Kit composto da - Kit consists of:</p> <ul style="list-style-type: none"> <li>- Meccanismo/Clutch Ref. 3540478M92 With box Original LANDINI</li> <li>- Disco Pto/Disc Pto Ref. 3105233M92 Not Original</li> <li>- Cuscinetto/Bearing Ref. 1423473M94 Not Original</li> <li>- Cuscinetto/Bearing Ref. 1442381X1 Not Original</li> </ul>		C 105 MAX - C 110 MAX, C 75 MAX - C 80 MAX, C 85 MAX - C 90 MAX, C 95 MAX, F 100 GT, F 105 F-GE-XL, F 90 GT, F 95 F-GE-XL, T 70 - T 80 - T 90 - T 100, V 70 - V 80	3540478M92, 6521050M91	   
LN3540478M92	Meccanismo Frizione 12" - Landini originale	MCCORMICK	C 105 MAX - C 110 MAX, C 75 MAX - C 80 MAX, C 85 MAX - C 90 MAX, C 95 MAX, F 100 GT, F 105 F-GE-XL, F 90 GT, F 95 F-GE-XL, T 70 - T 80 - T 90 - T 100, V 70 - V 80	3540478M92, 6521050M91	
07905	Disco Pto Diametro 310 mm - Pto Disc Diameter 310 mm		C 105 MAX - C 110 MAX, C 75 MAX - C 80 MAX, C 85 MAX - C 90 MAX, C 95 MAX, F 100 GT, F 105 F-GE-XL, F 90 GT, F 95 F-GE-XL, T 70 - T 80 - T 90 - T 100, V 70 - V 80	3105233M91, 3105233M92, 3311352M92	
12841	Cuscinetto reggispinta 90 x 50 x 21,60 mm / Thrust Bearing 90 x 50 x 21,60 mm		F60,F70,F75,F80,F85, T100,T70,T80,T90, V60,V65,V70,V80	1423473M93, 1966557C1	
15757	Cuscinetto pto 100 x 65 x 11 mm / Pto Bearing 100 x 65 x 11 mm		F100,F105,F60,E70,F75,F80,F85, F90,F95, T100,T70, T80, T90, V60,V65,V70,V80	1442381X1	
85028	<p>Kit composto da - Kit consists of:</p> <ul style="list-style-type: none"> <li>- Meccanismo/Clutch Ref. 3540478M92 With box Original LUK</li> <li>- Disco Pto/Disc Pto Ref. 3105233M92 Not Original</li> <li>- Cuscinetto/Bearing Ref. 1423473M94 Not Original</li> <li>- Cuscinetto/Bearing Ref. 1442381X1 Not Original</li> </ul>	MCCORMICK	C 105 MAX - C 110 MAX, C 75 MAX - C 80 MAX, C 85 MAX - C 90 MAX, C 95 MAX, F 100 GT, F 105 F-GE-XL, F 90 GT, F 95 F-GE-XL, T 70 - T 80 - T 90 - T 100, V 70 - V 80	3540478M92, 6521050M91	   

Art./Ref.	Note/Note	Brand	Applicazione/Application	Rif. Orig./Orig. Ref.	Immagine/Image
07903	Meccanismo Frizione 12" - Luk originale	MCCORMICK	C 105 MAX - C 110 MAX, C 75 MAX - C 80 MAX, C 85 MAX - C 90 MAX, C 95 MAX, F 100 GT, F 105 F-GE-XL, F 90 GT, F 95 F-GE-XL, T 70 - T 80 - T 90 - T 100, V 70 - V 80	3540478M92, 6521050M91	
07905	Disco Pto Diametro 310 mm - Pto Disc Diameter 310 mm		C 105 MAX - C 110 MAX, C 75 MAX - C 80 MAX, C 85 MAX - C 90 MAX, C 95 MAX, F 100 GT, F 105 F-GE-XL, F 90 GT, F 95 F-GE-XL, T 70 - T 80 - T 90 - T 100, V 70 - V 80	3105233M91, 3105233M92, 3311352M92	
12841	Cuscinetto reggispinta 90 x 50 x 21,60 mm / Thrust Bearing 90 x 50 x 21,60 mm		F60,F70,F75,F80,F85, T100,T70,T80,T90, V60,V65,V70,V80	1423473M93, 1966557C1	
15757	Cuscinetto pto 100 x 65 x 11 mm / Pto Bearing 100 x 65 x 11 mm		F100,F105,F60,F70,F75,F80,F85, F90,F95, T100,T70,T80,T90, V60,V65,V70,V80	1442381X1	
LUK631064210	Kit tutto originale LUK composto da - Kit all LUK original consists of: - Meccanismo/Clutch Ref. 231 0046 11 - Disco Pto/Disc Pto 331 0134 16 - Cuscinetto/Bearing Ref. 500 1159 10 - Cuscinetto/Bearing Ref. 500 1107 10 - Cuscinetto/Bearing Ref. 410 0042 10	MCCORMICK	C 105 MAX - C 110 MAX, C 75 MAX - C 80 MAX, C 85 MAX - C 90 MAX, C 95 MAX, F 100 GT, F 105 F-GE-XL, F 90 GT, F 95 F-GE-XL, T 70 - T 80 - T 90 - T 100, V 70 - V 80	1423473M94, 1442381X1, 3105233M92, 339599X1, 3540478M92, 6521050M91	    
LUK631064216	Kit tutto originale LUK composto da - Kit all LUK original consists of: - Meccanismo/Clutch Ref. 231 0046 11 - Disco Pto/Disc Pto 331 0134 16		C75 MAX - C80MAX - C85MAX, C90MAX - C95MAX - C105MAX, F90 - F95 - F100 - F105, T70 - T80 - T90, V70 - V80	3547012M93, 3547012M94, 6521049M91	 
LUK500115910	Cuscinetto reggispinta 94 x 50 x 22 mm / Thrust Bearing 94 x 50 x 22 mm		C 105 MAX - C 110 MAX, C 75 MAX - C 80 MAX, C 85 MAX - C 90 MAX, C 95 MAX, F 100 GT, F 105 F-GE-XL, F 90 GT, F 95 F-GE-XL, T 70 - T 80 - T 90 - T 100, V 70 - V 80	1423473M94	
LUK500110710	Cuscinetto pto 100 x 65 x 11 mm / Pto Bearing 100 x 65 x 11 mm		353, C75MAX, C80MAX, C85MAX, F75, F80, F85, T100, T70, T80, T90	1442381X1	
LUK410004210	Cuscinetto volano 47 x 20 x 14 mm - Bearing 47 x 20 x 14 mm		353, C75MAX, C80MAX, C85MAX, F75, F80, F85, T100, T70, T80, T90	339599X1	

**MECCANISMO + DISCO PTO ORIGINALE LUK RIF. 631064216**

MECANISME + DISQUE PTO ORIGINAL LUK 631064216

COVER ASSEMBLY + ORIGINAL PTO DISC LUK REF. 631064216

GETRIEBE + ZAPFWELLENSCHEIBE LUK 631064216

MECCANISMO + DISCO PTO ORIGINAL LUK REF. 631064216

Art./Ref.	Note/Note	Brand	Applicazione/Application	Rif. Orig./Orig. Ref.	Immagine/Image
LUK631064216	Kit tutto originale LUK composto da - Kit all LUK original consists of: - Meccanismo/Clutch Ref. 231 0046 11 - Disco Pto/Disc Pto 331 0134 16	MCCORMICK	C75MAX-C80MAX-C85MAX, C90MAX-C95MAX-C105MAX, F90 - F95 - F100 - F105, T70 - T80 - T90, V70 - V80	3547012M93, 3547012M94, 6521049M91	
LUK500115910	Cuscinetto reggispinta 94 x 50 x 22 mm / Thrust Bearing 94 x 50 x 22 mm		C 105 MAX - C 110 MAX, C 75 MAX - C 80 MAX, C 85 MAX - C 90 MAX, C 95 MAX, F 100 GT, F 105 F-GE-XL, F 90 GT, F 95 F-GE-XL, T 70 - T 80 - T 90 - T 100, V 70 - V 80	1423473M94	
LUK500110710	Cuscinetto pto 100 x 65 x 11 mm / Pto Bearing 100 x 65 x 11 mm		353, C75MAX, C80MAX, C85MAX, F75, F80, F85, T100, T70, T80, T90	1442381X1	
LUK410004210	Cuscinetto volano 47 x 20 x 14 mm - Bearing 47 x 20 x 14 mm		353, C75MAX, C80MAX, C85MAX, F75, F80, F85, T100, T70, T80, T90	339599X1	

**MECCANISMO + DISCO PTO ORIGINALE LUK RIF. 623306509**

MECANISME + DISQUE PTO ORIGINAL LUK 623306509

COVER ASSEMBLY + ORIGINAL PTO DISC LUK REF. 623306509

GETRIEBE + ZAPFWELLENSCHEIBE LUK 623306509

MECCANISMO + DISCO PTO ORIGINAL LUK REF. 623306509

Art./Ref.	Note/Note	Brand	Applicazione/Application	Rif. Orig./Orig. Ref.	Immagine/Image
LUK623306509	Kit tutto originale LUK composto da - Kit all LUK original consists of: - Meccanismo/Clutch Ref. 223 0028 10 - Disco Pto/Disc Pto 323 0471 10	MCCORMICK	GM 40 - 45 - 50 - 55, GX 40 - 40 H, GX 45 - 45 H, GX 50 - 50 H, GX 55 - 55 H	4202165M91, 6510438M91	
LUK500045900	Cuscinetto reggispinta 90 x 50 x 21,60 mm / Thrust Bearing 90 x 50 x 21,60 mm		F60, F70, F75, F80, F85, T100, T70, T80, T90, V60, V65, V70, V80	1423473M93, 1966557C1	
LUK500067300	Cuscinetto pto 100 x 65 x 18 mm / Pto Bearing 100 x 65 x 18 mm		GM 40 - 45 - 50 - 55, GX 40 - 40 H, GX 45 - 45 H, GX 50 - 50 H, GX 55 - 55 H	390947X1	
LUK410002400	Cuscinetto volano 35 x 15 x 11 mm - Bearing 35 x 15 x 11 mm		GM 40 - 45 - 50 - 55, GX 40 - 40 H, GX 45 - 45 H, GX 50 - 50 H, GX 55 - 55 H	339932X1	

**KIT FRIZIONE ADATTABILE RIF. 628052210 MASSEY FERGUSON**

KIT EMBRAYAGE ADAPTABLE REF. 628052210 MASSEY FERGUSON





KIT CLUTCH ADAPTABLE REF. 628052210 MASSEY FERGUSON

KIT KUPPLUNG PASSEND ZU REF. 628052210 MASSEY FERGUSON

KIT EMBRAGUE ADAPTABLE REF. 628052210 MASSEY FERGUSON

Art./Ref.	Note/Note	Brand	Applicazione/Application	Rif. Orig./Orig. Ref.	Immagine/Image
<b>83940</b>	Kit composto da - Kit consists of: - Meccanismo/Clutch Ref. 3540480M92 With box Original LANDINI - Disco Pto/Disc Pto Ref. 1424135M93 Not Original - Cuscinetto/Bearing Ref. 1423473M94 Not Original - Cuscinetto/Bearing Ref. 1442381X1 Not Original	<b>MASSEY FERGUSON</b>	134C-134V-154-154C-154F-154S, 154S-154V-164TF-164TS-164TV, 174-174C-174F-174S-174V-184, 184F - 184S - 184F - 194S, 233-234C-234CF-244CF-253-254, 234S-283-284-293-294-294C-294S, 254C-254CF-254S-263-263T-264T, 274-274C-274CF-274S-274SK-284S, 333-334V-353-353LX-353S-354AP, 354AQ-354F-354FP-354FQ-354GE, 354S-354SP-354V-354VQ-363-363S, 364FQ-364GE-364S-364SP-364SQ, 364SP-364AQ-364CF-364F-364FP, 364V-373LX-373S-374AP-374AQ, 367CF-376C-376CF-376XCF-377, 374F-374FP-374FQ-374GE-374H, 374S-374SP-374VQ-384S-393TLX, 383-383LX-383S-384AP-384AQ, 384F-384FP-384FQ-384SP-384SQ, 384V-384VQ-393-393LX-393S, 394AP-394AQ-394C-394F-394FQ, 394FP-394TAQ-396-396C-396CF, 394GE-394H-394S-394SP-394SQ, 396CF, 396CT	3540480M91, 3540480M92	
<b>LN3540480M91</b>	Meccanismo Frizione 11" - Landini originale		134C-134V-154-154C-154F-154S, 154S-154V-164TF-164TS-164TV, 174-174C-174F-174S-174V-184, 184F - 184S - 184F - 194S, 233-234C-234CF-244CF-253-254, 234S-283-284-293-294-294C-294S, 254C-254CF-254S-263-263T-264T, 274-274C-274CF-274S-274SK-284S, 333-334V-353-353LX-353S-354AP, 354AQ-354F-354FP-354FQ-354GE, 354S-354SP-354V-354VQ-363-363S, 364FQ-364GE-364S-364SP-364SQ, 364SP-364AQ-364CF-364F-364FP, 364V-373LX-373S-374AP-374AQ, 367CF-376C-376CF-376XCF-377, 374F-374FP-374FQ-374GE-374H, 374S-374SP-374VQ-384S-393TLX, 383-383LX-383S-384AP-384AQ, 384F-384FP-384FQ-384SP-384SQ, 384V-384VQ-393-393LX-393S, 394AP-394AQ-394C-394F-394FQ, 394FP-394TAQ-396-396C-396CF, 394GE-394H-394S-394SP-394SQ, 396CF, 396CT	3540480M91, 3540480M92	
<b>70467</b>	Disco Pto Diametro 280 mm - Pto Disc Diameter 280 mm		154-154C-154F-154S-154V, 174-174C-174F-174S-174V, 184-184F-184S, 194-194C-194F-194S, 233-234C-234CF-234S, 253-254-254C-254CF-254S, 263-263T-264T-264TCF-264TS, 274C-274CF-274S-274SK, 283-284-284S-293-294-294C-294S, 333-334V-353-353LX-353S, 354AP-354AQ-354F-354FP, 354FQ-354GE-354S-354SP-354SQ, 354V-354VQ-363, 364AP-364AQ-364CF-364F-364FP, 364FQ-364GE-364S-364SP-364SQ, 364V-364VQ-376CF-373-373S-374AP-374AQ-374F, 374FP-374FQ-374GE-374H-374S, 374SP-374SQ-374VQ, 376C-376CF-376XCF-377, 383-383LX-383S-384AP-384AQ, 384F-384FP-384FQ-384GE-384S, 384SP-384SQ-384V-384VQ, 393-393LX-393S-393TLX, 394AP-394AQ-394C-394F-394FP, 394AQ-394TAQ-396-396C-396CF, 394FQ-394GE-394H-394S-394SP	1424135M93	
<b>12841</b>	Cuscinetto reggispinta 90 x 50 x 21,60 mm / Thrust Bearing 90 x 50 x 21.60 mm		154, 154C, 154F, 154S, 154V, 174, 174C/F/S/V, 184, 184F/S, 194, 194C, 194F/S, 1007, 233, 234, 253, 254, 254C/CF/S, 263T, 264T/TCF/TS, 273, 274, 274C/CF/S/SK, 283, 284, 284S, 293, 294, 294C/S, 333, 333V, 353, 353LX/S, 354AP/AQ/F/FP/FQ/GE/S/SP/SQ/V, 363, 364AP/AQ/F/FP/FQ/GE/S/SP/SQ/V, 374AP/AQ/F/FP/FQ/GE/S/SP/SQ/V, 376C/CF/XCF, 377, 383, 383LX/S, 384AP/AQ/F/FP/FQ/GE/S/SP/SQ/V, 393, 393LX/S/TLX, 394AP/AQ/F/FP/FQ/GE/S/SP/SQ, 396	1423473M93, 391347X1	
<b>15757</b>	Cuscinetto pto 100 x 65 x 11 mm / Pto Bearing 100 x 65 x 11 mm		1007, 134, 154, 164, 174, 184, 194, 233, 234, 244, 253, 254, 263, 264, 274, 283, 284, 293, 294, 333, 334, 353, 354, 363, 364, 373, 374, 376, 377, 383, 384, 393, 394, 396	1442381X1	

Art./Ref.	Note/Note	Brand	Applicazione/Application	Rif. Orig./Orig. Ref.	Immagine/Image
<b>85025</b>	Kit composto da - Kit consists of: - Meccanismo/Clutch Ref. 3540480M92 With box Original LUK - Disco Pto/Disc Pto Ref. 1424135M93 Not Original - Cuscinetto/Bearing Ref. 1423473M94 Not Original - Cuscinetto/Bearing Ref. 1442381X1 Not Original	<b>MASSEY FERGUSON</b>	134C-134V-154-154C-154F-154S, 154S-154V-164TF-164TS-164TV, 174-174C-174F-174S-174V-184, 184F-184S-184F-194S, 233-234C-234CF-244CF-253-254, 234S-283-284-293-294-294C-294S, 254C-254CF-254S-263-263T-264T, 274-274C-274CF-274S-274SK-284S, 333-334V-353-353LX-353S-354AP, 354AQ-354F-354FP-354FQ-354GE, 354S-354SP-354V-354VQ-363-363S, 364FQ-364GE-364S-364SP-364SQ, 364SP-364AQ-364CF-364F-364FP, 364V-373LX-373S-374AP-374AQ, 367CF-376C-376CF-376XCF-377, 374F-374FP-374FQ-374GE-374H, 374S-374SP-374VQ-384S-393TLX, 383-383LX-383S-384AP-384AQ, 384F-384FP-384FQ-384SP-384SQ, 384V-384VQ-393-393LX-393S, 394AP-394AQ-394C-394F-394FQ, 394FP-394TAQ-396-396C-396CF, 394GE-394H-394S-394SP-394SQ, 396CF, 396CT	3540480M91, 3540480M92	  
<b>07898</b>	Meccanismo Frizione 11" - Luk originale		134C, 134V, 154, 154F/S/V, 174C/S/V, 184F/S, 194C/F/S, 244CF, 254C/CF/S, 263T, 264T/TS, 274C/CF/S, 284S, 294C/S, MF 367 CF, MF 376 C, MF 376 CF, MF 376 XCF, MF 377, MF 383, MF 383 LX, MF 383 S, MF 384 AQ, MF 384 F, MF 384 FQ, MF 384 SP-FP-AP-GE, MF 384 SQ, MF 384 V, MF 384 VQ, MF 384/3225 SPX-FPX-APX-GEX, MF 393, MF 393 LX, MF 393 S, MF 394 AQ, MF 394 F-H, MF 394 FQ, MF 394 SP-FP-AP-GE, MF 394 SQ, MF 394/3235 SPX-FPX-APX-GEX, MF 396 CF	3304583M95, 3540480M91, 3540480M92, 3600242M91	
<b>70467</b>	Disco Pto Diametro 280 mm - Pto Disc Diameter 280 mm		154-154C-154F-154S-154V, 174-174C-174F-174S-174V, 184-184F-184S, 194-194C-194F-194S, 233-234C-234CF-234S, 253-254-254C-254CF-254S, 263-263T-264T-264TF-264TS, 274C-274CF-274S-274SK, 283-284-284S-293-294-294C-294S, 333-334V-353-353LX-353S, 354AP-354AQ-354F-354FP, 354FQ-354GE-354S-354SP-354SQ, 354V-354VQ-363, 364AP-364AQ-364CF-364F-364FP, 364FQ-364GE-364S-364SP-364SQ, 364V-364VQ-367CF, 373-373S-374AP-374AQ-374F, 374FP-374FQ-374GE-374H-374S, 374SP-374SQ-374VQ, 376C-376CF-376XCF-377, 383-383LX-383S-384AP-384AQ, 384F-384FP-384FQ-384GE-384S, 384SP-384SQ-384V-384VQ, 393-393LX-393S-393TLX, 394AP-394AQ-394C-394F-394FP, 394AQ-394TAQ-396-396C-396CF, 394FQ-394GE-394H-394S-394SP	1424135M93	
<b>12841</b>	Cuscinetto reggispinta 90 x 50 x 21,60 mm / Thrust Bearing 90 x 50 x 21,60 mm		154, 154C, 154F, 154S, 154V, 174, 174C/F/S/V, 184, 184F/S, 194, 194C, 194F/S, 1007, 233, 234, 253, 254, 254C/CF/S, 263T, 264T/TS, 273, 274, 274C/CF/S/SK, 283, 284, 284S, 293, 294, 294C/S, 333, 333V, 353, 353LX/S, 354AP/AQ/F/FP/FQ/GE/S/SP/SQ/V, 363, 364AP/AQ/F/FP/FQ/GE/S/SP/SQ/V, 374AP/AQ/F/FP/FQ/GE/S/SP/SQ/V, 376C/CF/XCF, 377, 383, 383LX/S, 384AP/AQ/F/FP/FQ/GE/S/SP/SQ/V, 393, 393LX/S/TLX, 394AP/AQ/F/FP/FQ/GE/S/SP/SQ, 396	1423473M93, 391347X1	
<b>15757</b>	Cuscinetto pto 100 x 65 x 11 mm / Pto Bearing 100 x 65 x 11 mm		1007, 134, 154, 164, 174, 184, 194, 233, 234, 244, 253, 254, 263, 264, 274, 283, 284, 293, 294, 333, 334, 353, 354, 363, 364, 373, 374, 376, 377, 383, 384, 393, 394, 396	1442381X1	
<b>LUK628052210</b>	Kit tutto originale LUK composto da - Kit all LUK original consists of: - Meccanismo/Clutch Ref. 228 0003 14 - Disco Pto/Disc Pto 328 0083 16 - Cuscinetto/Bearing Ref. 500 0459 00 - Cuscinetto/Bearing Ref. 500 1107 10 - Cuscinetto/Bearing Ref. 410 0042 10	<b>MASSEY FERGUSON</b>	134C-134V-154-154C-154F-154S, 154S-154V-164TF-164TS-164TV, 174-174C-174F-174S-174V-184, 184F-184S-184F-194S, 233-234C-234CF-244CF-253-254, 234S-283-284-293-294-294C-294S, 254C-254CF-254S-263-263T-264T, 274-274C-274CF-274S-274SK-284S, 333-334V-353-353LX-353S-354AP, 354AQ-354F-354FP-354FQ-354GE, 354S-354SP-354V-354VQ-363-363S, 364FQ-364GE-364S-364SP-364SQ, 364SP-364AQ-364CF-364F-364FP, 364V-373LX-373S-374AP-374AQ, 367CF-376C-376CF-376XCF-377, 374F-374FP-374FQ-374GE-374H, 374S-374SP-374VQ-384S-393TLX, 383-383LX-383S-384AP-384AQ, 384F-384FP-384FQ-384SP-384SQ, 384V-384VQ-393-393LX-393S, 394AP-394AQ-394C-394F-394FQ, 394FP-394TAQ-396-396C-396CF, 394GE-394H-394S-394SP-394SQ, 396CF, 396CT	1423473M94, 1424135M94, 1442381X1, 339599X1, 3540480M91, 3540480M92	    

Art./Ref.	Note/Note	Brand	Applicazione/Application	Rif. Orig./Orig. Ref.	Immagine/Image
<b>LUK628052209</b>	Kit tutto originale LUK composto da - Kit all LUK original consists of: - Meccanismo/Clutch Ref. 228 0003 14 - Disco Pto/Disc Pto 328 0083 16	<b>MASSEY FERGUSON</b>	134C-134V-154-154C-154F-154S, 154S-154V, 164TF-164TS-164TV, 174-174C-174F-174S-174V-184, 184F - 184S - 184F - 194S, 233-234C-234CF-244CF-253-254, 234S-283-284-293-294-294C-294S, 254C-254CF-254S-263-263T-264T, 274-274C-274CF-274S-274SK-284S, 333-334V-353-353LX-353S-354AP, 354AQ-354F-354FP-354FQ-354GE, 354S-354SP-354V-354VQ-363-363S, 364FQ-364GE-364S-364SP-364SQ, 364SP-364AQ-364CF-364F-364FP, 364V-373LX-373S-374AP-374AQ, 367CF-376C-376CF-376XCF-377, 374F-374FP-374FQ-374GE-374H, 374S-374SP-374VQ-384S-393TLX, 383-383LX-383S-384AP-384AQ, 384F-384FP-384FQ-384SP-384SQ, 384V-384VQ-393-393LX-393S, 394AP-394AQ-394C-394F-394FQ, 394FP-394TAQ-396-396C-396CF, 394GE-394H-394S-394SP-394SQ, 396CF, 396CT	1424135M94, 3540480M91, 3540480M92	 
<b>LUK500043900</b>	Cuscinetto reggispinta 90 x 50 x 21,60 mm / Thrust Bearing 90 x 50 x 21,60 mm		154, 154C, 154F, 154S, 154V, 174, 174C/F/S/V, 184, 184F/S, 194, 194C, 194F/S, 1007, 233, 234, 253, 254, 254C/CF/S, 263T, 264T/TCF/TS, 273, 274, 274C/CF/S/SK, 283, 284, 284S, 293, 294, 294C/S, 333, 333V, 353, 353LX/S, 354AP/AQ/F/FP/FQ/GE/S/SP/SQ/V, 363, 364AP/AQ/F/FP/FQ/GE/S/SP/SQ/V, 374AP/AQ/F/FP/FQ/GE/S/SP/SQ/V, 376C/CF/XCF, 377, 383, 383LX/S, 384AP/AQ/F/FP/FQ/GE/S/SP/SQ/V, 393, 393LX/S/TLX, 394AP/AQ/F/FP/FQ/GE/S/SP/SQ, 396	1423473M93, 391347X1	
<b>LUK500110710</b>	Cuscinetto pto 100 x 65 x 11 mm / Pto Bearing 100 x 65 x 11 mm		134C, 134V, 154, 154F/S/V, 174C/S/V, 184F/S, 194C/F/S, 244CF, 254C/CF/S, 263T, 264T/TS, 274C/CF/S, 284S, 294C/S, MF 367 CF, MF 376 C, MF 376 CF, MF 376 XCF, MF 377, MF 383, MF 383 LX, MF 383 S, MF 384 AQ, MF 384 F, MF 384 FQ, MF 384 SP-FP-AP-GE, MF 384 SQ, MF 384 V, MF 384 VQ, MF 384/3225 SPX-FPX-APX-GEX, MF 393, MF 393 LX, MF 393 S, MF 394 AQ, MF 394 F-H, MF 394 FQ, MF 394 SP-FP-AP-GE, MF 394 SQ, MF 394/3235 SPX-FPX-APX-GEX, MF 396 CF	1442381X1	
<b>LUK410004210</b>	Cuscinetto volano 47 x 20 x 14 mm - Bearing 47 x 20 x 14 mm		134C, 134V, 154, 154F/S/V, 174C/S/V, 184F/S, 194C/F/S, 244CF, 254C/CF/S, 263T, 264T/TS, 274C/CF/S, 284S, 294C/S, MF 367 CF, MF 376 C, MF 376 CF, MF 376 XCF, MF 377, MF 383, MF 383 LX, MF 383 S, MF 384 AQ, MF 384 F, MF 384 FQ, MF 384 SP-FP-AP-GE, MF 384 SQ, MF 384 V, MF 384 VQ, MF 384/3225 SPX-FPX-APX-GEX, MF 393, MF 393 LX, MF 393 S, MF 394 AQ, MF 394 F-H, MF 394 FQ, MF 394 SP-FP-AP-GE, MF 394 SQ, MF 394/3235 SPX-FPX-APX-GEX, MF 396 CF	339599X1	





**KIT FRIZIONE ADATTABILE RIF. 631064210 MASSEY FERGUSON**

KIT EMBRAYAGE ADAPTABLE REF. 631064210 MASSEY FERGUSON

KIT CLUTCH ADAPTABLE REF. 631064210 MASSEY FERGUSON

KIT KUPPLUNG PASSEND ZU REF. 631064210 MASSEY FERGUSON

KIT EMBRAQUE ADAPTABLE REF. 631064210 MASSEY FERGUSON

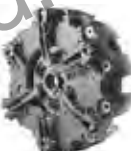
Art./Ref.	Note/Note	Brand	Applicazione/Application	Rif. Orig./Orig. Ref.	Immagine/Image
<b>83941</b>	Kit composto da - Kit consists of: - Meccanismo/Clutch Ref. 3540478M92 With box Original LANDINI - Disco Pto/Disc Pto Ref. 3105233M92 Not Original - Cuscinetto/Bearing Ref. 1423473M94 Not Original - Cuscinetto/Bearing Ref. 1442381X1 Not Original	<b>MASSEY FERGUSON</b>	1007, 154-154C-154F-154S-154V, 174-174C-174S-174V, 184-184F-184S, 194-194C-194F-194S, 233-234C-234CF-234S, 244CF-253-254-254C-254CF-254S, 263-263T-264T, 274-274C-274CF-274S-274SK, 283-284-284S-293-294-294C-294S, 333-334V-353-353LX-353S, 354AP-354AQ-354F-354FP-354FQ, 354GE-354S-354SP-354V-354VQ, 363-363S-364AP-364AQ-364CF, 364F-364FP-364FQ-364GE-364S, 364SP-364SQ-364V-373LX-373S, 374AP-374AQ-374F-374FP-374FQ, 374GE-374H-374S-374SP-374V, 374VQ-376C-376CF-376XCF-377, 383-383LX-383S-384AP-384AQ, 384F-384FP-384GE-384S-384SP, 384SQ-384V-384VQ-387, 393-393LX-393S-393TLX, 394AP-394FP-394FQ-394GE-394H, 394S-394SP-394SQ-394TAQ, 396-396C-396CF, 397 - 397T	3540478M92, 6521050M91	   
<b>LN3540478M92</b>	Meccanismo Frizione 12" - Landini originale		1007, 154-154C-154F-154S-154V, 174-174C-174S-174V, 184-184F-184S, 194-194C-194F-194S, 233-234C-234CF-234S, 244CF-253-254-254C-254CF-254S, 263-263T-264T, 274-274C-274CF-274S-274SK, 283-284-284S-293-294-294C-294S, 333-334V-353-353LX-353S, 354AP-354AQ-354F-354FP-354FQ, 354GE-354S-354SP-354V-354VQ, 363-363S-364AP-364AQ-364CF, 364F-364FP-364FQ-364GE-364S, 364SP-364SQ-364V-373LX-373S, 374AP-374AQ-374F-374FP-374FQ, 374GE-374H-374S-374SP-374V, 374VQ-376C-376CF-376XCF-377, 383-383LX-383S-384AP-384AQ, 384F-384FP-384GE-384S-384SP, 384SQ-384V-384VQ-387, 393-393LX-393S-393TLX, 394AP-394FP-394FQ-394GE-394H, 394S-394SP-394SQ-394TAQ, 396-396C-396CF, 397 - 397T	3540478M92, 6521050M91	

Art./Ref.	Note/Note	Brand	Applicazione/Application	Rif. Orig./Orig. Ref.	Immagine/Image
<b>07905</b>	Disco Pto Diametro 310 mm - Pto Disc Diameter 310 mm	<b>MASSEY FERGUSON</b>	MF 1007, MF 373, MF 373 LX, MF 373 S, MF 374 AQ, MF 374 FQ, MF 374 SP-FP-AP-GE, MF 374 SQ, MF 374 V, MF 374 VQ, MF 374/3220 SPX-FPX-APX-GEX, MF 376 C, MF 377, MF 383, MF 383 LX, MF 383 S, MF 384 AQ, MF 384 FQ, MF 384 SP-FP-AP-GE, MF 384 SQ, MF 384 V, MF 384 VQ, MF 384/3225 SPX-FPX-APX-GEX, MF 387, MF 393, MF 393 LX, MF 393 S, MF 393 TLX, MF 394 AQ, MF 394 FQ, MF 394 SP-FP-AP-GE, MF 394 SQ, MF 394 T, MF 394/3235 SPX-FPX-APX-GEX, MF 396 C, MF 396 CT, MF 397, MF 397 T, MF 3977	3105233M91, 3105233M92, 3311352M92	
<b>12841</b>	Cuscinetto reggispinta 90 x 50 x 21,60 mm / Thrust Bearing 90 x 50 x 21,60 mm		154,154C,154F,154S,154V,174, 174C/F/S/V,184,184F/S,194,194C, 194F/S,1007,233,234,253,254, 254C/CF/S,263T,264T/TCF/TS, 273,274,274C/ CF/S/SK,283,284, 284S,293,294,294C/S,333,333V, 353,353LX/S, 354AP/AQ/F/FP/ FQ/GE/S/SP/SQ/V, 363, 364AP/AQ/F/FP/FQ/GE/S/SP/SQ/V, 374AP/AQ/F/FP/FQ/ GE/S/SP/SQ/V, 376C/CF/XCF,377,383,383LX/S, 384AP/AQ/F/FP/FQ/GE/S/SP/SQ/V, 393,393LX/S/TLX, 394AP/AQ/F/FP/FQ/GE/S/SP/SQ, 396	1423473M93, 391347X1	
<b>15757</b>	Cuscinetto pto 100 x 65 x 11 mm / Pto Bearing 100 x 65 x 11 mm		1007, 134,154,164,174,184,194, 233,234,244,253,254,263,264, 274,283,284,293,294, 333,334,353,354,363,364,373, 374,376,377,383,384,393,394, 396	1442381X1	
<b>85028</b>	Kit composto da - Kit consists of: - Meccanismo/Clutch Ref. 3540478M92 With box Original LUK - Disco Pto/Disc Pto Ref. 3105233M92 Not Original - Cuscinetto/Bearing Ref. 1423473M94 Not Original - Cuscinetto/Bearing Ref. 1442381X1 Not Original	<b>MASSEY FERGUSON</b>	1007, 154-154C-154F-154S-154V, 174-174C-174S-174V, 184-184F-184S, 194-194C-194F-194S, 233-234C-234CF-234S, 244CF-253-254-254C-254CF-254S, 263-263T-264T, 274-274C-274CF-274S-274SK, 283-284-284S-293-294-294C-294S, 333-334V-353-353LX-353S, 354AP-354AQ-354F-354FP-354FQ, 354GE-354S-354SP- 354V-354VQ, 363-363S-364AP-364AQ-364CF, 364F-364FP-364FQ-364GE-364S, 364SP-364SQ-364V-373LX-373S, 374AP-374AQ-374F-374FP-374FQ, 374GE-374H- 374S-374SP-374V, 374VQ-376C-376CF-376XCF-377, 383-383LX-383S-384AP- 384AQ, 384F-384FP-384GE-384S-384SP, 384SQ-384V-384VQ-387, 393-393LX- 393S-393TLX, 394AP-394FP-394FQ-394GE-394H, 394S-394SP-394SQ-394TAQ, 396-396C-396CF, 397 - 397T	3540478M92, 6521050M91	
<b>07903</b>	Meccanismo Frizione 12" - Luk originale		1007, 154-154C-154F-154S-154V, 174-174C-174S-174V, 184-184F-184S, 194-194C-194F-194S, 233-234C-234CF-234S, 244CF-253-254-254C-254CF-254S, 263-263T-264T-264TCF, 273-274-274C-274CF-274S-274SK, 283-284-284S, 293-294-294C-294S, 333-334V-353-353LX-353S, 354AP-354AQ-354F-354FP-354FQ, 354GE-354S-354SP-354SQ-354V, 354VQ-363-363S, 364AP-364AQ-364CF-364F- 364FP, 364FQ-364GE-364S-364SP-364SQ, 364V-364VQ-367CF-373-373LX, 373S- 374AP-374AQ-374F-374FP, 374FQ-374GE-374H-374S-374SP, 374V-374VQ-376C- 376CF-376XCF, 377-383-383LX-383S-384AP, 384AQ-384F-384FP-384FQ-384GE, 384S-384SP-384SQ-384V-384VQ, 387-393-393LX-393S-393TLX, 394AP-394AQ- 394C-394F-394FP, 394FQ-394GE-394H-394S-394SP, 394SQ-394TAQ-396-396C- 396CF, 396CT-397-397T	3532192M96, 3532193M94, 3540478M91, 3540478M92, 3547072M93, 6521050M91	
<b>07905</b>	Disco Pto Diametro 310 mm - Pto Disc Diameter 310 mm		MF 1007, MF 373, MF 373 LX, MF 373 S, MF 374 AQ, MF 374 FQ, MF 374 SP-FP-AP-GE, MF 374 SQ, MF 374 V, MF 374 VQ, MF 374/3220 SPX-FPX-APX-GEX, MF 376 C, MF 377, MF 383, MF 383 LX, MF 383 S, MF 384 AQ, MF 384 FQ, MF 384 SP-FP-AP-GE, MF 384 SQ, MF 384 V, MF 384 VQ, MF 384/3225 SPX-FPX-APX-GEX, MF 387, MF 393, MF 393 LX, MF 393 S, MF 393 TLX, MF 394 AQ, MF 394 FQ, MF 394 SP-FP-AP-GE, MF 394 SQ, MF 394 T, MF 394/3235 SPX-FPX-APX-GEX, MF 396 C, MF 396 CT, MF 397, MF 397 T, MF 3977	3105233M91, 3105233M92, 3311352M92	
<b>12841</b>	Cuscinetto reggispinta 90 x 50 x 21,60 mm / Thrust Bearing 90 x 50 x 21,60 mm		154,154C,154F,154S,154V,174, 174C/F/S/V,184,184F/S,194,194C, 194F/S,1007,233,234,253,254, 254C/CF/S,263T,264T/TCF/TS, 273,274,274C/ CF/S/SK,283,284, 284S,293,294,294C/S,333,333V, 353,353LX/S, 354AP/AQ/F/FP/ FQ/GE/S/SP/SQ/V, 363, 364AP/AQ/F/FP/FQ/GE/S/SP/SQ/V, 374AP/AQ/F/FP/FQ/ GE/S/SP/SQ/V, 376C/CF/XCF,377,383,383LX/S, 384AP/AQ/F/FP/FQ/GE/S/SP/SQ/V, 393,393LX/S/TLX, 394AP/AQ/F/FP/FQ/GE/S/SP/SQ, 396	1423473M93, 391347X1	
<b>15757</b>	Cuscinetto pto 100 x 65 x 11 mm / Pto Bearing 100 x 65 x 11 mm		1007, 134,154,164,174,184,194, 233,234,244,253,254,263,264, 274,283,284,293,294, 333,334,353,354,363,364,373, 374,376,377,383,384,393,394, 396	1442381X1	

Art./Ref.	Note/Note	Brand	Applicazione/Application	Rif. Orig./Orig. Ref.	Immagine/Image
<b>LUK631064210</b>	Kit tutto originale LUK composto da - Kit all LUK original consists of: - Meccanismo/Clutch Ref. 231 0046 11 - Disco Pto/Disc Pto 331 0134 16 - Cuscinetto/Bearing Ref. 500 1159 10 - Cuscinetto/Bearing Ref. 500 1107 10 - Cuscinetto/Bearing Ref. 410 0042 10		1007, 154-154C-154F-154S-154V, 174-174C-174S-174V, 184-184F-184S, 194-194C-194F-194S, 233-234C-234CF-234S, 244CF-253-254-254C-254CF-254S, 263-263T-264T, 274-274C-274CF-274S-274SK, 283-284-284S-293-294-294C-294S, 333-334V-353-353LX-353S, 354AP-354AQ-354F-354FP-354FQ, 354GE-354S-354SP-354V-354VQ, 363-363S-364AP-364AQ-364CF, 364F-364FP-364FQ-364GE-364S, 364SP-364SQ-364V-373LX-373S, 374AP-374AQ-374F-374FP-374FQ, 374GE-374H-374S-374SP-374V, 374VQ-376C-376CF-376XCF-377, 383-383LX-383S-384AP-384AQ, 384F-384FP-384GE-384S-384SP, 384SQ-384V-384VQ-387, 393-393LX-393S-393TLX, 394AP-394FP-394FQ-394GE-394H, 394S-394SP-394SQ-394TAQ, 396-396C-396CF, 397 - 397T	1423473M94, 1442381X1, 3105233M92, 339599X1, 3540478M92, 6521050M91	    
<b>LUK631064216</b>	Kit tutto originale LUK composto da - Kit all LUK original consists of: - Meccanismo/Clutch Ref. 231 0046 11 - Disco Pto/Disc Pto 331 0134 16	<b>MASSEY FERGUSON</b>	1007, 154-154C-154F-154S-154V, 174-174C-174S-174V, 184-184F-184S, 194-194C-194F-194S, 233-234C-234CF-234S, 244CF-253-254-254C-254CF-254S, 263-263T-264T, 274-274C-274CF-274S-274SK, 283-284-284S-293-294-294C-294S, 333-334V-353-353LX-353S, 354AP-354AQ-354F-354FP-354FQ, 354GE-354S-354SP-354V-354VQ, 363-363S-364AP-364AQ-364CF, 364F-364FP-364FQ-364GE-364S, 364SP-364SQ-364V-373LX-373S, 374AP-374AQ-374F-374FP-374FQ, 374GE-374H-374S-374SP-374V, 374VQ-376C-376CF-376XCF-377, 383-383LX-383S-384AP-384AQ, 384F-384FP-384GE-384S-384SP, 384SQ-384V-384VQ-387, 393-393LX-393S-393TLX, 394AP-394FP-394FQ-394GE-394H, 394S-394SP-394SQ-394TAQ, 396-396C-396CF, 397 - 397T	3547012M93, 3547012M94, 6521049M91	 
<b>LUK500115910</b>	Cuscinetto reggispinta 94 x 50 x 22 mm / Thrust Bearing 94 x 50 x 22 mm		1007, 154-154C-154F-154S-154V, 174-174C-174S-174V, 184-184F-184S, 194-194C-194F-194S, 233-234C-234CF-234S, 244CF-253-254-254C-254CF-254S, 263-263T-264T, 274-274C-274CF-274S-274SK, 283-284-284S-293-294-294C-294S, 333-334V-353-353LX-353S, 354AP-354AQ-354F-354FP-354FQ, 354GE-354S-354SP-354V-354VQ, 363-363S-364AP-364AQ-364CF, 364F-364FP-364FQ-364GE-364S, 364SP-364SQ-364V-373LX-373S, 374AP-374AQ-374F-374FP-374FQ, 374GE-374H-374S-374SP-374V, 374VQ-376C-376CF-376XCF-377, 383-383LX-383S-384AP-384AQ, 384F-384FP-384GE-384S-384SP, 384SQ-384V-384VQ-387, 393-393LX-393S-393TLX, 394AP-394FP-394FQ-394GE-394H, 394S-394SP-394SQ-394TAQ, 396-396C-396CF, 397 - 397T	1423473M94	
<b>LUK500110710</b>	Cuscinetto pto 100 x 65 x 11 mm / Pto Bearing 100 x 65 x 11 mm		134C, 134V, 154, 154F/S/V, 174C/S/V, 184F/S, 194C/F/S, 244CF, 254C/CF/S, 263T, 264T/TS, 274C/CF/S, 284S, 294C/S, MF 367 CF, MF 376 C, MF 376 CF, MF 376 XCF, MF 377, MF 383, MF 383 LX, MF 383 S, MF 384 AQ, MF 384 F, MF 384 FQ, MF 384 SP-FP-AP-GE, MF 384 SQ, MF 384 V, MF 384 VQ, MF 384/3225 SPX-FPX-APX-GEX, MF 393, MF 393 LX, MF 393 S, MF 394 AQ, MF 394 F-H, MF 394 FQ, MF 394 SP-FP-AP-GE, MF 394 SQ, MF 394/3235 SPX-FPX-APX-GEX, MF 396 CF	1442381X1	
<b>LUK410004210</b>	Cuscinetto volano 47 x 20 x 14 mm - Bearing 47 x 20 x 14 mm		134C, 134V, 154, 154F/S/V, 174C/S/V, 184F/S, 194C/F/S, 244CF, 254C/CF/S, 263T, 264T/TS, 274C/CF/S, 284S, 294C/S, MF 367 CF, MF 376 C, MF 376 CF, MF 376 XCF, MF 377, MF 383, MF 383 LX, MF 383 S, MF 384 AQ, MF 384 F, MF 384 FQ, MF 384 SP-FP-AP-GE, MF 384 SQ, MF 384 V, MF 384 VQ, MF 384/3225 SPX-FPX-APX-GEX, MF 393, MF 393 LX, MF 393 S, MF 394 AQ, MF 394 F-H, MF 394 FQ, MF 394 SP-FP-AP-GE, MF 394 SQ, MF 394/3235 SPX-FPX-APX-GEX, MF 396 CF	339599X1	

**MECCANISMO + DISCO PTO ORIGINALE LUK RIF. 631064216**

MECANISME + DISQUE PTO ORIGINAL LUK 631064216

COVER ASSEMBLY + ORIGINAL PTO DISC LUK REF. 631064216

GETRIEBE + ZAPFWELLENSCHEIBE LUK 631064216

MECANISMO + DISCO PTO ORIGINAL LUK REF. 631064216

Art./Ref.	Note/Note	Brand	Applicazione/Application	Rif. Orig./Orig. Ref.	Immagine/Image
<b>LUK631064216</b>	Kit tutto originale LUK composto da - Kit all LUK original consists of: - Meccanismo/Clutch Ref. 231 0046 11 - Disco Pto/Disc Pto 331 0134 16	<b>MASSEY FERGUSON</b>	1007, 154-154C-154F-154S-154V, 174-174C-174S-174V, 184-184F-184S, 194-194C-194F-194S, 233-234C-234CF-234S, 244CF-253-254-254C-254CF-254S, 263-263T-264T, 274-274C-274CF-274S-274SK, 283-284-284S-293-294-294C-294S, 333-334V-353-353LX-353S, 354AP-354AQ-354F-354FP-354FQ, 354GE-354S-354SP-354V-354VQ, 363-363S-364AP-364AQ-364CF, 364F-364FP-364FQ-364GE-364S, 364SP-364SQ-364V-373LX-373S, 374AP-374AQ-374F-374FP-374FQ, 374GE-374H-374S-374SP-374V, 374VQ-376C-376CF-376XCF-377, 383-383LX-383S-384AP-384AQ, 384F-384FP-384GE-384S-384SP, 384SQ-384V-384VQ-387, 393-393LX-393S-393TLX, 394AP-394FP-394FQ-394GE-394H, 394S-394SP-394SQ-394TAQ, 396-396C-396CF, 397 - 397T	3547012M93, 3547012M94, 6521049M91	 



Art./Ref.	Note/Note	Brand	Applicazione/Application	Rif. Orig./Orig. Ref.	Immagine/Image
<b>LUK500115910</b>	Cuscinetto reggispinta 94 x 50 x 22 mm / Thrust Bearing 94 x 50 x 22 mm	<b>MASSEY FERGUSON</b>	1007, 154-154C-154F-154S-154V, 174-174C-174S-174V, 184-184F-184S, 194-194C-194F-194S, 233-234C-234CF-234S, 244CF-253-254-254C-254CF-254S, 263-263T-264T, 274-274C-274CF-274S-274SK, 283-284-284S-293-294-294C-294S, 333-334V-353-353LX-353S, 354AP-354AQ-354F-354FP-354FQ, 354GE-354S-354SP-354V- 354VQ, 363-363S-364AP-364AQ-364CF, 364F-364FP-364FQ-364GE-364S, 364SP-364SQ- 364V-373LX-373S, 374AP-374AQ-374F-374FP-374FQ, 374GE-374H-374S-374SP-374V, 374VQ-376C-376CF-376XCF-377, 383-383LX-383S-384AP-384AQ, 384F-384FP- 384GE-384S-384SP, 384SQ-384V-384VQ-387, 393-393LX-393S-393TLX, 394AP-394FP- 394FQ-394GE-394H, 394S-394SP-394SQ-394TAQ, 396-396C-396CF, 397 - 397T	1423473M94	
<b>LUK500110710</b>	Cuscinetto pto 100 x 65 x 11 mm / Pto Bearing 100 x 65 x 11 mm		134C,134V,154,154F/S/V, 174C/S/V,184F/S,194C/F/S, 244CF,254C/CF/S,263T,264T/TS, 274C/CF/S,284S,294C/S, MF 367 CF, MF 376 C, MF 376 CF, MF 376 XCF, MF 377, MF 383, MF 383 LX, MF 383 S, MF 384 AQ, MF 384 F, MF 384 FQ, MF 384 SP-FP-AP-GE, MF 384 SQ, MF 384 V, MF 384 VQ, MF 384/3225 SPX-FPX-APX-GEX, MF 393, MF 393 LX, MF 393 S, MF 394 AQ, MF 394 F-H, MF 394 FQ, MF 394 SP-FP-AP-GE, MF 394 SQ, MF 394/3235 SPX-FPX-APX-GEX, MF 396 CF	1442381X1	
<b>LUK410004210</b>	Cuscinetto volano 47 x 20 x 14 mm - Bearing 47 x 20 x 14 mm		134C,134V,154,154F/S/V, 174C/S/V,184F/S,194C/F/S, 244CF,254C/CF/S,263T,264T/TS, 274C/CF/S,284S,294C/S, MF 367 CF, MF 376 C, MF 376 CF, MF 376 XCF, MF 377, MF 383, MF 383 LX, MF 383 S, MF 384 AQ, MF 384 F, MF 384 FQ, MF 384 SP-FP-AP-GE, MF 384 SQ, MF 384 V, MF 384 VQ, MF 384/3225 SPX-FPX-APX-GEX, MF 393, MF 393 LX, MF 393 S, MF 394 AQ, MF 394 F-H, MF 394 FQ, MF 394 SP-FP-AP-GE, MF 394 SQ, MF 394/3235 SPX-FPX-APX-GEX, MF 396 CF	339599X1	

**MECCANISMO + DISCO PTO ORIGINALE LUK RIF. 633052319**

MECANISME + DISQUE PTO ORIGINAL LUK 633052319

COVER ASSEMBLY + ORIGINAL PTO DISC LUK REF. 633052319

GETRIEBE + ZAPFWELLENSCHEIBE LUK 633052319

MECCANISMO + DISCO PTO ORIGINALE LUK RIF. 633052319

Art./Ref.	Note/Note	Brand	Applicazione/Application	Rif. Orig./Orig. Ref.	Immagine/Image
<b>LUK633052319</b>	Kit tutto originale LUK composto da - Kit all LUK original consists of: - Meccanismo/Clutch Ref. 233 0020 12 - Disco Pto/Disc Pto 333 0019 16	<b>MASSEY FERGUSON</b>	1014 (22904565->),1114,1134, 1024	1426390M94, 3303137M95, 3533765M93, 3540481M91	 
<b>07906</b>	Meccanismo Frizione 13" - Luk originale		1007, 1014 (22904565->),1114,1134, 1024	3303137M95, 3533765M93, 3540481M91	
<b>07908</b>	Disco Pto Diametro 330 mm - Pto Disc Diameter 330 mm		1007, 1014, 1114, 1134	1426390M93, 1426390M94	
<b>59850</b>	Cuscinetto reggispinta 92 x 55 x 31 mm / Thrust Bearing 92 x 55 x 31 mm		1014 (->22904564), 1014 (22904565- >),1114,1134, 1024	3302143M91	
<b>70427</b>	Cuscinetto pto 115 x 75 x 13 mm / Pto Bearing 115 x 75 x 13 mm		1014 (22904565->),1114,1134, 1024	392191X1	
<b>70433</b>	Cuscinetto volano 52 x 25 x 18 mm - Bea- ring 52 x 25 x 18 mm		1014 (22904565->),1114,1134, 1024	392168X1	

**KIT FRIZIONE LUK 628302414**

KIT EMBRAYAGE LUK 628302414

KIT CLUTCH LUK 628302414

KIT KUPPLUNG LUK 628302414

KIT EMBRAGUE LUK 628302414

Art./Ref.	Note/Note	Brand	Applicazione/Application	Rif. Orig./Orig. Ref.	Immagine/Image
<b>LUK628302414</b>	Kit tutto originale LUK composto da - Kit all LUK original consists of: - Meccanismo/Clutch Ref. 228 0209 11 - Disco Pto/Disc Pto 328 0377 11 - Cuscinetto/Bearing Ref. 500 0459 00 - Cuscinetto/Bearing Ref. 500 0058 10 - Cuscinetto/Bearing Ref. 410 0026 00		AGROCLIMBER 310 VC/L/M/N, AGROCLIMBER V 70 C - V 70 N, AGROCLIMBER V 80 L - V 80 M, AGROCLIMBER V 80 N	0.012.2574.0, 0.012.2574.4, 0.012.2574.4/10, 0.014.9428.3, 0.020.3544.4, 2.2999.209.0, 2.2999.478.0	
<b>85585</b>	Meccanismo Frizione 11" - Luk originale	<b>DEUTZ</b>	AGROCLIMBER 310 VC/L/M/N, AGROCLIMBER V 70 C - V 70 N, AGROCLIMBER V 80 L - V 80 M, AGROCLIMBER V 80 N, AGROPLUS 420 F ECOLINE	0.012.2574.4, 0.012.2574.4/10, 0.020.3543.4, 0.020.3544.4	
<b>LUK328037711</b>	Disco Pto Diametro 280 mm Luk originale - Pto Disc Diameter 280 mm Original Luk		AGROCLIMBER 310 VC/L/M/N, AGROCLIMBER V 70 C - V 70 N, AGROCLIMBER V 80 L - V 80 M, AGROCLIMBER V 80 N, AGROPLUS 420 F ECOLINE	0.011.9073.3	
<b>LUK500045900</b>	Cuscinetto reggispinta 90 x 50 x 21,60 mm / Thrust Bearing 90 x 50 x 21,60 mm		AGROCLIMBER 310 VC/L/M/N, AGROCLIMBER V 70 C - V 70 N, AGROCLIMBER V 80 L - V 80 M, AGROCLIMBER V 80 N, AGROPLUS 420 F ECOLINE	2.2999.478.0	
<b>LUK500005810</b>	Cuscinetto pto 140 x 106 x 21 mm / Pto Bearing 140 x 106 x 21 mm		AGROCLIMBER 310 VC/L/M/N, AGROCLIMBER V 70 C - V 70 N, AGROCLIMBER V 80 L - V 80 M, AGROCLIMBER V 80 N	2.2999.209.0	
<b>LUK410002600</b>	Cuscinetto volano 47 x 20 x 14 mm - Bearing 47 x 20 x 14 mm		AGROCLIMBER 310 VC/L/M/N, AGROCLIMBER V 70 C - V 70 N, AGROCLIMBER V 80 L - V 80 M, AGROCLIMBER V 80 N		

**MECCANISMO + DISCO AVANZAMENTO ORIGINALE LUK RIF. 628313109**

MECANISME + DISQUE AVANCEMENT ORIGINAL LUK 628313109  
 COVER ASSEMBLY + ORIGINAL MAIN DRIVE LUK REF. 628313109  
 GETRIEBE + VORSCHLEIBE LUK 628313109  
 MECANISMO + DISCO DE AVANCE ORIGINAL LUK REF. 628313109

Art./Ref.	Note/Note	Brand	Applicazione/Application	Rif. Orig./Orig. Ref.	Immagine/Image
<b>LUK628313109</b>	Kit tutto originale LUK composto da - Kit all LUK original consists of: - Meccanismo/Clutch Ref. 128 0336 10 - Disco Avanzamento/Clutch Disc 328 0275 11	<b>DEUTZ</b>	DEUTZ AGROCOMPACT F60 - F70, DEUTZ AGROLUX 60, DEUTZ AGROLUX F50 - F60, DEUTZ AGROPLUS 60 - 67 - F70	0.015.9286.3, 0.015.9287.3, 0.270.2330.3/10	

**MECCANISMO + DISCO AVANZAMENTO ORIGINALE LUK RIF. 631308219 - 631308209**

MECANISME + DISQUE AVANCEMENT ORIGINAL LUK 631308219 - 631308209  
 COVER ASSEMBLY + ORIGINAL MAIN DRIVE LUK REF. 631308219 - 631308209  
 GETRIEBE + VORSCHLEIBE LUK 631308219 - 631308209  
 MECANISMO + DISCO DE AVANCE ORIGINAL LUK REF. 631308219 - 631308209

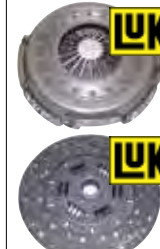
Art./Ref.	Note/Note	Brand	Applicazione/Application	Rif. Orig./Orig. Ref.	Immagine/Image
<b>LUK631308219</b>	Kit tutto originale LUK composto da - Kit all LUK original consists of: - Meccanismo/Clutch Ref. 131 0228 10 - Disco Avanzamento a 6 pale/Clutch Disc 6 pairs of pads 331 0179 11	<b>DEUTZ</b>	DEUTZ AGROCLIMBER F 100 M, DEUTZ AGROCLIMBER F 100 N, DEUTZ AGROCLIMBER F 90 C, DEUTZ AGROCLIMBER F 90 M, DEUTZ AGROCLIMBER F 90 N, DEUTZ AGROCOMPACT F 100 - F 70, DEUTZ AGROCOMPACT F 75 - F 80, DEUTZ AGROCOMPACT F 90, DEUTZ AGROLUX 60 - 70 - 77, DEUTZ AGROLUX 77 LP, DEUTZ AGROLUX F 60 - F 70, DEUTZ AGROLUX F 80, DEUTZ AGROPLUS 67 - 70 - 77, DEUTZ AGROPLUS 80 - 87, DEUTZ AGROPLUS F 100 - F 70, DEUTZ AGROPLUS F 75 - F 90	0.015.9285.3, 0.015.9289.3	
<b>LUK631308209</b>	Kit tutto originale LUK composto da - Kit all LUK original consists of: - Meccanismo/Clutch Ref. 131 0228 10 - Disco Avanzamento/Clutch Disc 331 0179 10		DEUTZ AGROCLIMBER F 100 M, DEUTZ AGROCLIMBER F 100 N, DEUTZ AGROCLIMBER F 90 C, DEUTZ AGROCLIMBER F 90 M, DEUTZ AGROCLIMBER F 90 N, DEUTZ AGROCOMPACT F 100 - F 70, DEUTZ AGROCOMPACT F 75 - F 80, DEUTZ AGROCOMPACT F 90, DEUTZ AGROLUX 60 - 70 - 77, DEUTZ AGROLUX 77 LP, DEUTZ AGROLUX F 60 - F 70, DEUTZ AGROLUX F 80, DEUTZ AGROPLUS 67 - 70 - 77, DEUTZ AGROPLUS 80 - 87, DEUTZ AGROPLUS F 100 - F 70, DEUTZ AGROPLUS F 75 - F 90	0.015.9285.3, 0.015.9288.3	

**MECCANISMO + DISCO AVANZAMENTO ORIGINALE LUK RIF. 633303109**

MECANISME + DISQUE AVANCEMENT ORIGINAL LUK 633303109  
 COVER ASSEMBLY + ORIGINAL MAIN DRIVE LUK REF. 633303109  
 GETRIEBE + VORSCHLEIBE LUK 633303109  
 MECANISMO + DISCO DE AVANCE ORIGINAL LUK 633303109

Art./Ref.	Note/Note	Brand	Applicazione/Application	Rif. Orig./Orig. Ref.	Immagine/Image
<b>LUK633303109</b>	Kit tutto originale LUK composto da - Kit all LUK original consists of: - Meccanismo/Clutch Ref. 133 0259 10 - Disco Avanzamento a 5 pale/Clutch Disc 5 pairs of pads 333 0186 10	<b>DEUTZ</b>	DEUTZ AGROCLIMBER 105, DEUTZ AGROCLIMBER 410 - 410SIX, DEUTZ AGROFARM 100, DEUTZ AGROFARM 100 ECOLINE, DEUTZ AGROFARM 420 - 420T, DEUTZ AGROFARM 430, DEUTZ AGROLUX 100 - 80, DEUTZ AGROLUX 87 - 87 LP, DEUTZ AGROLUX 90 - 95, DEUTZ AGROLUX 97 - 97 LP, DEUTZ AGROPLUS 95 NEW, DEUTZ AGROTRAC 100 - 110	0.012.7094.3, 0.012.7095.3/10	



**MECCANISMO + DISCO AVANZAMENTO ORIGINALE LUK RIF. 635351009**

MECANISME + DISQUE AVANCEMENT ORIGINAL LUK 635351009

COVER ASSEMBLY + ORIGINAL MAIN DRIVE LUK REF. 635351009

GETRIEBE + VORSCHLEIBE LUK 635351009

MECANISMO + DISCO DE AVANCE ORIGINAL LUK 635351009

Art./Ref.	Note/Note	Brand	Applicazione/Application	Rif. Orig./Orig. Ref.	Immagine/Image
<b>LUK635351009</b>	Kit tutto originale LUK composto da - Kit all LUK original consists of: - Meccanismo/Clutch Ref. 135 0279 10 - Disco Avanzamento a 7 pale/Clutch Disc 7 pairs of pads 335 0321 10		DEUTZ AGROSUN 100 - 120 - 140, DEUTZ AGROTRAC 110 - 125, DEUTZ AGROTRAC 130 - 150	0.014.0175.4, 0.014.0176.3	
<b>LUK500059730</b>	Cuscinetto reggispinta completo 111 x 65 x 30 mm / Bearing + carrier assy 111 x 65 x 30 mm	<b>DEUTZ</b>	AGROSUN 120, AGROSUN 140, AGROTRAC 130, AGROTRAC 150	0.250.6533.3, 0.264.6533.3/20	
<b>LUK500084630</b>	Cuscinetto reggispinta 90,60 x 55 x 22 mm / Thrust Bearing 90,60 x 55 x 22 mm		AGROTRAC 125, AGROTRAC 130, AGROTRAC 150, AGROTRAC 610, AGROTRAC 620	2.2999.207.0, 2.2999.510.0	



**KIT FRIZIONE LUK 625300710**

KIT EMBRAYAGE LUK 625300710

KIT CLUTCH LUK 625300710

KIT KUPPLUNG LUK 625300710

KIT EMBRAGUE LUK 625300710

Art./Ref.	Note/Note	Brand	Applicazione/Application	Rif. Orig./Orig. Ref.	Immagine/Image
<b>LUK625300710</b>	Kit tutto originale LUK composto da - Kit all LUK original consists of: - Meccanismo/Clutch Ref. 225 0055 10 - Disco Pto/Disc Pto 323 0556 10 - Cuscinetto/Bearing Ref. 500 0459 00 - Cuscinetto/Bearing Ref. 500 0673 00 - Cuscinetto/Bearing Ref. 410 0026 00	<b>DEUTZ</b>	DEUTZ AGROLUX 57 - F 57	0.008.4743.4, 0.008.4744.3, 0.011.9063.3, 0.012.2564.4, 2.2021.018.0, 2.2999.153.0/10, 2.2999.478.0	
<b>LUK500045900</b>	Cuscinetto reggispinta 90 x 50 x 21,60 mm / Thrust Bearing 90 x 50 x 21,60 mm		AGROCLIMBER 310 VC/L/M/N, AGROCLIMBER V 70 C - V 70 N, AGROCLIMBER V 80 L - V 80 M, AGROCLIMBER V 80 N, AGROPLUS 420 F ECOLINE, DEUTZ AGROLUX 57 - F 57	2.2999.478.0	

Art./Ref.	Note/Note	Brand	Applicazione/Application	Rif. Orig./Orig. Ref.	Immagine/Image
LUK500067300	Cuscinetto pto 100 x 65 x 18 mm / Pto Bearing 100 x 65 x 18 mm	DEUTZ	DEUTZ AGROLUX 57 - F 57	2.2021.017.0	
LUK410002600	Cuscinetto volano 47 x 20 x 14 mm - Bearing 47 x 20 x 14 mm		AGROCLIMBER 310 VC/L/M/N, AGROCLIMBER V 70 C - V 70 N, AGROCLIMBER V 80 L - V 80 M, AGROCLIMBER V 80 N, DEUTZ AGROLUX 57 - F 57		

**KIT FRIZIONE LUK 631107510**

KIT EMBRAYAGE LUK 631107510

KIT CLUTCH LUK 631107510

KIT KUPPLUNG LUK 631107510

KIT EMBRAGUE LUK 631107510

Art./Ref.	Note/Note	Brand	Applicazione/Application	Rif. Orig./Orig. Ref.	Immagine/Image
LUK631107510	Kit tutto originale LUK composto da - Kit all LUK original consists of: - Meccanismo/Clutch Ref. 131 0229 10 - Disco avanzamento/Disc clutch 331 0184 10 - Cuscinetto/Bearing Ref. 500 0076 11	DEUTZ	DEUTZ AGROCOMPACT F 60	0.014.9424.3, 0.014.9433.3, 2.2999.475.0	

**MECCANISMO + DISCO AVANZAMENTO ORIGINALE LUK RIF. 633535310 - 635353810**

MECANISME + DISQUE AVANCEMENT ORIGINAL LUK 635353510 - 635353810

COVER ASSEMBLY + ORIGINAL MAIN DRIVE LUK REF. 635353510 - 635353810

GETRIEBE + VORSCHLEIBE LUK 635353510 - 635353810

MECANISMO + DISCO DE AVANCE ORIGINAL LUK REF. 635353510 - 635353810

Art./Ref.	Note/Note	Brand	Applicazione/Application	Rif. Orig./Orig. Ref.	Immagine/Image
LUK635353510	Kit tutto originale LUK composto da - Kit all LUK original consists of: - Meccanismo/Clutch Ref. 135 0284 10 - Disco avanzamento 330 mm Z24/Disc clutch 330 mm Z24 333 0215 10 - Cuscinetto/Bearing Ref. 500 0076 11	DEUTZ	DEUTZ AGROLUX 80 - 90, DEUTZ AGROPLUS 75 - 85 - 95	0.015.6381.3, 0.015.6386.3, 2.2999.475.0	
LUK635353810	Kit tutto originale LUK composto da - Kit all LUK original consists of: - Meccanismo/Clutch Ref. 135 0284 10 - Disco avanzamento 350 mm Z24/Disc clutch 350 mm Z24 335 0337 10 - Cuscinetto/Bearing Ref. 500 0076 11		DEUTZ AGROLUX 80 - 90, DEUTZ AGROPLUS 75 - 85 - 95	0.015.6328.3, 0.015.6386.3, 2.2999.475.0	

**KIT FRIZIONE LUK ORIGINALE RIF. MECCANISMO 0.014.9017.3**

KIT EMBRAYAGE LUK ORIGINAL REF. 0.014.9017.3

KIT CLUTCH ORIGINAL LUK REF. 0.014.9017.3

KIT KUPPLUNG LUK REF. 0.014.9017.3

KIT EMBRAGUE LUK ORIGINAL REF. 0.014.9017.3

Art./Ref.	Note/Note	Brand	Applicazione/Application	Rif. Orig./Orig. Ref.	Immagine/Image
<b>LUK131031210</b>	Meccanismo Frizione 12" - Luk originale	<b>DEUTZ</b>	AGROCLIMBER 400 F - 410 F, AGROCLIMBER F 100 M - F 100 N, AGROCLIMBER F 90 C - F 90 M, AGROCLIMBER F 90 N, AGROFARM 410 - 410 T, AGROFARM 410 T ECOLINE, AGROFARM 410 TB, AGROFARM 420 T ECOLINE, AGROFARM 420 TB, AGROFARM 85 - 85 ECOLINE, AGROLUX 80 - 85, AGROPLUS 100 S, AGROPLUS 315 - 320 - 320 F, AGROPLUS 320 V - 330 V, AGROPLUS 410 - 410 F - 410 V, AGROPLUS 420 F - 420 V, AGROPLUS 430 F - 430 V, AGROPLUS 70 S - 75 S - 90 S, AGROPLUS F 100 - F 70 - F 75, AGROPLUS F 90	0.014.9017.3	
<b>LUK331034610</b>	Disco avanzamento 310 mm a 6 pale Luk originale - Clutch Disc Diameter 310 mm 6 pairs of pads Original Luk		AGROCLIMBER 400 F - 410 F, AGROCLIMBER F 100 M - F 100 N, AGROCLIMBER F 90 C - F 90 M, AGROCLIMBER F 90 N, AGROFARM 410 - 410 T, AGROFARM 410 T ECOLINE, AGROFARM 410 TB, AGROFARM 420 T ECOLINE, AGROFARM 420 TB, AGROFARM 85 - 85 ECOLINE, AGROLUX 80 - 85, AGROPLUS 100 S, AGROPLUS 315 - 320 - 320 F, AGROPLUS 320 V - 330 V, AGROPLUS 410 - 410 F - 410 V, AGROPLUS 420 F - 420 V, AGROPLUS 430 F - 430 V, AGROPLUS 70 S - 75 S - 90 S, AGROPLUS F 100 - F 70 - F 75, AGROPLUS F 90	0.014.9017.3	

**KIT FRIZIONE LUK ORIGINALE RIF. MECCANISMO 0.016.6106.3**

KIT EMBRAYAGE LUK ORIGINAL REF. 0.016.6106.3

KIT CLUTCH ORIGINAL LUK REF. 0.016.6106.3

KIT KUPPLUNG LUK REF. 0.016.6106.3

KIT EMBRAGUE LUK ORIGINAL REF. 0.016.6106.3

Art./Ref.	Note/Note	Brand	Applicazione/Application	Rif. Orig./Orig. Ref.	Immagine/Image
<b>LUK135028510</b>	Meccanismo Frizione 14" - Luk originale	<b>DEUTZ</b>	DEUTZ AGROLUX 80 - 90	0.016.6106.3	
<b>LUK333011610</b>	Disco avanzamento 330 mm a 6 pale Luk originale - Clutch Disc Diameter 330 mm 6 pairs of pads Original Luk		DEUTZ AGROLUX 80 - 90	0.016.6105.3	

**KIT FRIZIONE ADATTABILE RIF. 628302415 SDF**

KIT EMBRAYAGE ADAPTABLE REF. 628302415 SDF

KIT CLUTCH ADAPTABLE REF. 628302415 SDF

KIT KUPPLUNG PASSEND ZU REF. 628302415 SDF

KIT EMBRAGUE ADAPTABLE REF. 628302415 SDF

Art./Ref.	Note/Note	Brand	Applicazione/Application	Rif. Orig./Orig. Ref.	Immagine/Image
<b>85586</b>	Kit composto da - Kit consists of: - Meccanismo/Clutch Ref. 0.012.2574.4 With box Original SDF - Disco Pto/Disc Pto Ref. 0.014.9428.3 Not Original - Cuscinetto/Bearing Ref. 2.2999.478.0 Not Original - Cuscinetto/Bearing Ref. 2.2021.018.0 Not Original	<b>HURLIMANN</b>	H 361 - H 361 XF, H 362 - H 372, H 476 XF - H 481 XF, H 491 XF, H 55 XF - H 70 XF - X 90 XF	0.012.2574.4, 0.012.2574.4/10, 0.014.9428.3, 0.020.3544.4, 2.2021.018.0, 2.2999.478.0	

Art./Ref.	Note/Note	Brand	Applicazione/Application	Rif. Orig./Orig. Ref.	Immagine/Image
<b>VO.012.2574.4</b>	Meccanismo Frizione 11" - Sdf originale	<b>HURLIMANN</b>	H 100 XF, H 306 XE - H 307 XE, H 361 XF - H 476 XF, H 481 XF - H 491 XF, H 55 XF - H 70 XF, H 75 XF - H 90 XF, XF 100 TRADITION, XF 90 TRADITION	0.012.2574.4, 0.012.2574.4/10, 0.020.3543.4, 0.020.3544.4	
<b>85474</b>	Disco Pto Diametro 280 mm - Pto Disc Diameter 280 mm		H 100 XF, H 306 XE - H 307 XE, H 361 XF - H 476 XF, H 481 XF - H 491 XF, H 55 XF - H 70 XF, H 75 XF - H 90 XF, XF 100 TRADITION, XF 90 TRADITION	0.014.9428.3	
<b>12841</b>	Cuscinetto reggispinta 90 x 50 x 21,60 mm / Thrust Bearing 90 x 50 x 21,60 mm		H 100 XF, H 306 XE - H 307 XE, H 361 XF - H 476 XF, H 481 XF - H 491 XF, H 55 XF - H 70 XF, H 75 XF - H 90 XF, H305XE, H306XE, H307XE, H375, XF 100 TRADITION, XF 90 TRADITION	2.2999.153.0, 2.2999.153.0/10, 2.2999.478.0	
<b>14882</b>	Cuscinetto pto 110 x 70 x 20 mm / Pto Bearing 110 x 70 x 20 mm		H 100 XF, H 306 XE - H 307 XE, H 361 XF - H 476 XF, H 481 XF - H 491 XF, H 55 XF - H 70 XF, H 75 XF - H 90 XF, XF 100 TRADITION, XF 90 TRADITION	2.2021.018.0	
<b>85587</b>	Kit composto da - Kit consists of: - Meccanismo/Clutch Ref. 0.012.2574.4 With box Original LUK - Disco Pto/Disc Pto Ref. 0.014.9428.3 Not Original - Cuscinetto/Bearing Ref. 2.2999.478.0 Not Original - Cuscinetto/Bearing Ref. 2.2021.018.0 Not Original	<b>HURLIMANN</b>	H 361 - H 361 XF, H 362 - H 372, H 476 XF - H 481 XF, H 491 XF, H 55 XF - H 70 XF - X 90 XF	0.012.2574.4, 0.012.2574.4/10, 0.014.9428.3, 0.020.3544.4, 2.2021.018.0, 2.2999.478.0	   
<b>85585</b>	Meccanismo Frizione 11" - Luk originale	<b>HURLIMANN</b>	H 100 XF, H 306 XE - H 307 XE, H 361 XF - H 476 XF, H 481 XF - H 491 XF, H 55 XF - H 70 XF, H 75 XF - H 90 XF, XF 100 TRADITION, XF 90 TRADITION	0.012.2574.4, 0.012.2574.4/10, 0.020.3543.4, 0.020.3544.4	
<b>85474</b>	Disco Pto Diametro 280 mm - Pto Disc Diameter 280 mm		H 100 XF, H 306 XE - H 307 XE, H 361 XF - H 476 XF, H 481 XF - H 491 XF, H 55 XF - H 70 XF, H 75 XF - H 90 XF, XF 100 TRADITION, XF 90 TRADITION	0.014.9428.3	
<b>12841</b>	Cuscinetto reggispinta 90 x 50 x 21,60 mm / Thrust Bearing 90 x 50 x 21,60 mm		H 100 XF, H 306 XE - H 307 XE, H 361 XF - H 476 XF, H 481 XF - H 491 XF, H 55 XF - H 70 XF, H 75 XF - H 90 XF, H305XE, H306XE, H307XE, H375, XF 100 TRADITION, XF 90 TRADITION	2.2999.153.0, 2.2999.153.0/10, 2.2999.478.0	
<b>14882</b>	Cuscinetto pto 110 x 70 x 20 mm / Pto Bearing 110 x 70 x 20 mm		H 100 XF, H 306 XE - H 307 XE, H 361 XF - H 476 XF, H 481 XF - H 491 XF, H 55 XF - H 70 XF, H 75 XF - H 90 XF, XF 100 TRADITION, XF 90 TRADITION	2.2021.018.0	

Art./Ref.	Note/Note	Brand	Applicazione/Application	Rif. Orig./Orig. Ref.	Immagine/Image
<b>LUK628302415</b>	Kit tutto originale LUK composto da - Kit all LUK original consists of: - Meccanismo/Clutch Ref. 228 0209 11 - Disco Pto/Disc Pto 328 0377 11 - Cuscinetto/Bearing Ref. 500 0459 00 - Cuscinetto/Bearing Ref. 500 0284 00 - Cuscinetto/Bearing Ref. 410 0026 00		H 361 - H 361 XF, H 362 - H 372, H 476 XF - H 481 XF, H 491 XF, H 55 XF - H 70 XF - H 90 XF	0.012.2574.4, 0.012.2574.4/10, 0.014.9428.3, 0.020.3544.4, 2.2021.018.0, 2.2999.478.0	    
<b>85585</b>	Meccanismo Frizione 11" - Luk originale	<b>HURLIMANN</b>	H 100 XF, H 306 XE - H 307 XE, H 361 XF - H 476 XF, H 481 XF - H 491 XF, H 55 XF - H 70 XF, H 75 XF - H 90 XF, XF 100 TRADITION, XF 90 TRADITION	0.012.2574.4, 0.012.2574.4/10, 0.020.3543.4, 0.020.3544.4	
<b>LUK328037711</b>	Disco Pto Diametro 280 mm Luk originale - Pto Disc Diameter 280 mm Original Luk		H 100 XF, H 306 XE - H 307 XE, H 361 XF - H 476 XF, H 481 XF - H 491 XF, H 55 XF - H 70 XF, H 75 XF - H 90 XF, XF 100 TRADITION, XF 90 TRADITION	0.011.9073.3	
<b>LUK500045900</b>	Cuscinetto reggispinta 90 x 50 x 21,60 mm / Thrust Bearing 90 x 50 x 21,60 mm		H 100 XF, H 306 XE - H 307 XE, H 361 XF - H 476 XF, H 481 XF - H 491 XF, H 55 XF - H 70 XF, H 75 XF - H 90 XF, H305XE, H306XE, H307XE, H375, XF 100 TRADITION, XF 90 TRADITION	2.2999.153.0, 2.2999.153.0/10, 2.2999.478.0	
<b>LUK500028400</b>	Cuscinetto pto 110 x 70 x 20 mm / Pto Bearing 110 x 70 x 20 mm		H 100 XF, H 306 XE - H 307 XE, H 361 XF - H 476 XF, H 481 XF - H 491 XF, H 55 XF - H 70 XF, H 75 XF - H 90 XF, XF 100 TRADITION, XF 90 TRADITION	2.2021.018.0	
<b>LUK410002600</b>	Cuscinetto volano 47 x 20 x 14 mm - Bearing 47 x 20 x 14 mm		H 361 - H 361 XF, H 362 - H 372, H 476 XF - H 481 XF, H 491 XF, H 55 XF - H 70 XF - H 90 XF		

**MECCANISMO + DISCO AVANZAMENTO ORIGINALE LUK RIF. 628313109**

MECANISME + DISQUE AVANCEMENT ORIGINAL LUK 628313109

COVER ASSEMBLY + ORIGINAL MAIN DRIVE LUK REF. 628313109

GETRIEBE + VORSCHLEIBE LUK 628313109

MECANISMO + DISCO DE AVANCE ORIGINAL LUK REF. 628313109

Art./Ref.	Note/Note	Brand	Applicazione/Application	Rif. Orig./Orig. Ref.	Immagine/Image
<b>LUK628313109</b>	Kit tutto originale LUK composto da - Kit all LUK original consists of: - Meccanismo/Clutch Ref. 128 0336 10 - Disco Avanzamento/Clutch Disc 328 0275 11	<b>HURLIMANN</b>	HURLIMANN H356, HURLIMANN H358 - H358 PRESTIGE, HURLI- MANN H358-4 CLUB, HURLIMANN H466 - H466-4, HURLIMANN H468 - H468 PRESTIGE, HURLIMANN H468-4 CLUB, HURLIMANN H468-4 CLUB BASSO, HURLIMANN XA56, HURLIMANN XA56 TRADITION, HURLIMANN XA606 - XA655, HURLIMANN XA656T, HURLIMANN XA66, HURLIMANN XA66 TRADITION, HURLIMANN XF55 - XF70, HURLIMANN XN706 - XN707, HURLIMANN XS70	0.015.9286.3 0.015.9287.3 0.270.2330.3/10	 



**MECCANISMO + DISCO AVANZAMENTO ORIGINALE LUK RIF. 631308219 - 631308209**

MECANISME + DISQUE AVANCEMENT ORIGINAL LUK 631308219 - 631308209  
 COVER ASSEMBLY + ORIGINAL MAIN DRIVE LUK REF. 631308219 - 631308209  
 GETRIEBE + VORSCHLEIBE LUK 631308219 - 631308209  
 MECANISMO + DISCO DE AVANCE ORIGINAL LUK REF. 631308219 - 631308209

Art./Ref.	Note/Note	Brand	Applicazione/Application	Rif. Orig./Orig. Ref.	Immagine/Image
<b>LUK631308219</b>	Kit tutto originale LUK composto da - Kit all LUK original consists of: - Meccanismo/Clutch Ref. 131 0228 10 - Disco Avanzamento a 6 pale/Clutch Disc 6 pairs of pads 331 0179 11	<b>HURLIMANN</b>	HURLIMANN H468 PRESTIGE, HURLIMANN H468-4 CLUB, HURLIMANN H468-4 CLUB BASSO, HURLIMANN H476 - H478, HURLIMANN H478 PRESTIGE, HURLIMANN H486T - H488T, HURLIMANN PRESTIGE 75TRADITION, HURLIMANN XA607 - XA655, HURLIMANN XA656T - XA657, HURLIMANN XA658 - XA76, HURLIMANN XA76 TRADITION, HURLIMANN XA86, HURLIMANN XA86 TRADITION, HURLIMANN XB75T - XB75TB, HURLIMANN XF100 - XF55 - XF70, HURLIMANN XF75 - XF90, HURLIMANN XN708 - XN709, HURLIMANN XS100 - XS70 - XS75, HURLIMANN XS90	0.015.9285.3, 0.015.9289.3	
<b>LUK631308209</b>	Kit tutto originale LUK composto da - Kit all LUK original consists of: - Meccanismo/Clutch Ref. 131 0228 10 - Disco Avanzamento/Clutch Disc 331 0179 10		HURLIMANN H468 PRESTIGE, HURLIMANN H468-4 CLUB, HURLIMANN H468-4 CLUB BASSO, HURLIMANN H476 - H478, HURLIMANN H478 PRESTIGE, HURLIMANN H486T - H488T, HURLIMANN PRESTIGE 75TRADITION, HURLIMANN XA607 - XA655, HURLIMANN XA656T - XA657, HURLIMANN XA658 - XA76, HURLIMANN XA76 TRADITION, HURLIMANN XA86, HURLIMANN XA86 TRADITION, HURLIMANN XB75T - XB75TB, HURLIMANN XF100 - XF55 - XF70, HURLIMANN XF75 - XF90, HURLIMANN XN708 - XN709, HURLIMANN XS100 - XS70 - XS75, HURLIMANN XS90	0.015.9285.3, 0.015.9288.3	

**MECCANISMO + DISCO AVANZAMENTO ORIGINALE LUK RIF. 633303109**

MECANISME + DISQUE AVANCEMENT ORIGINAL LUK 633303109  
 COVER ASSEMBLY + ORIGINAL MAIN DRIVE LUK REF. 633303109  
 GETRIEBE + VORSCHLEIBE LUK 633303109  
 MECANISMO + DISCO DE AVANCE ORIGINAL LUK 633303109

Art./Ref.	Note/Note	Brand	Applicazione/Application	Rif. Orig./Orig. Ref.	Immagine/Image
<b>LUK633303109</b>	Kit tutto originale LUK composto da - Kit all LUK original consists of: - Meccanismo/Clutch Ref. 133 0259 10 - Disco Avanzamento a 5 pale/Clutch Disc 5 pairs of pads 333 0186 10	<b>HURLIMANN</b>	HURLIMANN XB 100 T - XB 100 TB, HURLIMANN XB 105 - 105 T, HURLIMANN XB 85 - XB 95, HURLIMANN XB MAX 100, HURLIMANN XB MAX 100 TRADITION, HURLIMANN XB MAX 110, HURLIMANN XT 105 - XT 110, HURLIMANN XT 85 - XT 95	0.012.7094.3, 0.012.7095.3/10	

**MECCANISMO + DISCO AVANZAMENTO ORIGINALE LUK RIF. 635304509**

MECANISME + DISQUE AVANCEMENT ORIGINAL LUK 635304509  
 COVER ASSEMBLY + ORIGINAL MAIN DRIVE LUK REF. 635304509  
 GETRIEBE + VORSCHLEIBE LUK 635304509  
 MECANISMO + DISCO DE AVANCE ORIGINAL LUK 635304509

Art./Ref.	Note/Note	Brand	Applicazione/Application	Rif. Orig./Orig. Ref.	Immagine/Image
<b>LUK635304509</b>	Kit tutto originale LUK composto da - Kit all LUK original consists of: - Meccanismo/Clutch Ref. 135 0241 10 - Disco Avanzamento a 6 pale/Clutch Disc 6 pairs of pads 335 0186 10	<b>HURLIMANN</b>	HURLIMANN ELITE 6135 XB, HURLIMANN XT 115 - XT 130, HURLIMANN XT 913	0.008.5595.3, 0.008.5596.3	
<b>LUK500084630</b>	Cuscinetto reggispinta 90,60 x 55 x 22 mm / Thrust Bearing 90,60 x 55 x 22 mm		HURLIMANN ELITE 6115 XB, HURLIMANN ELITE 6135 XB, HURLIMANN H478 PRESTIGE, HURLIMANN H478-4, HURLIMANN H488 T PRESTIGE, HURLIMANN H6115 ELITE, HURLIMANN H6135 ELITE, HURLIMANN XT 115 - XT 130, HURLIMANN XT 908, HURLIMANN XT 909, HURLIMANN XT 910.4, HURLIMANN XT 910.6, HURLIMANN XT 913	2.2999.207.0, 2.2999.510.0	





**MECCANISMO + DISCO AVANZAMENTO ORIGINALE LUK RIF. 635351009**

MECANISME + DISQUE AVANCEMENT ORIGINAL LUK 635351009

COVER ASSEMBLY + ORIGINAL MAIN DRIVE LUK REF. 635351009

GETRIEBE + VORSCHLEIBE LUK 635351009

MECANISMO + DISCO DE AVANCE ORIGINAL LUK 635351009

Art./Ref.	Note/Note	Brand	Applicazione/Application	Rif. Orig./Orig. Ref.	Immagine/Image
<b>LUK635351009</b>	Kit tutto originale LUK composto da - Kit all LUK original consists of: - Meccanismo/Clutch Ref. 135 0279 10 - Disco Avanzamento a 7 pale/Clutch Disc 7 pairs of pads 335 0321 10	<b>HURLIMANN</b>	HURLIMANN H490 - H496T - H5110, HURLIMANN H5116T - H5160, HURLIMANN H6136 - H6160, HURLIMANN H6170T	0.014.0175.4, 0.014.0176.3	  
<b>LUK500059730</b>	Cuscinetto reggispinta completo 111 x 65 x 30 mm / Bearing + carrier assy 111 x 65 x 30 mm		H 6136, H 6170 T	0.250.6533.3, 0.264.6533.3/20	
<b>LUK500084630</b>	Cuscinetto reggispinta 90,60 x 55 x 22 mm / Thrust Bearing 90,60 x 55 x 22 mm		HURLIMANN ELITE 6115 XB, HURLIMANN ELITE 6135 XB, HURLIMANN H478 PRESTIGE, HURLIMANN H478-4, HURLIMANN H488 T PRESTIGE, HURLIMANN H6115 ELITE, HURLIMANN H6135 ELITE, HURLIMANN XT 115 - XT 130, HURLIMANN XT 908, HURLIMANN XT 909, HURLIMANN XT 910.4, HURLIMANN XT 910.6, HURLIMANN XT 913	2.2999.207.0, 2.2999.510.0	









**KIT FRIZIONE LUK 625300710**

KIT EMBRAYAGE LUK 625300710

KIT CLUTCH LUK 625300710

KIT KUPPLUNG LUK 625300710

KIT EMBRAGUE LUK 625300710

Art./Ref.	Note/Note	Brand	Applicazione/Application	Rif. Orig./Orig. Ref.	Immagine/Image
<b>LUK625300710</b>	Kit tutto originale LUK composto da - Kit all LUK original consists of: - Meccanismo/Clutch Ref. 225 0055 10 - Disco Pto/Disc Pto 323 0556 10 - Cuscinetto/Bearing Ref. 500 0459 00 - Cuscinetto/Bearing Ref. 500 0673 00 - Cuscinetto/Bearing Ref. 410 0026 00	<b>HURLIMANN</b>	HURLIMANN H351, HURLIMANN XE 55 TRADITION, HURLIMANN XE F 55 TRADITION	0.008.4743.4, 0.008.4744.3, 0.011.9063.3, 0.012.2564.4, 2.2021.018.0, 2.2999.153.0/10, 2.2999.478.0	    
<b>LUK500045900</b>	Cuscinetto reggispinta 90 x 50 x 21,60 mm / Thrust Bearing 90 x 50 x 21,60 mm		H 100 XF, H 306 XE - H 307 XE, H 361 XF - H 476 XF, H 481 XF - H 491 XF, H 55 XF - H 70 XF, H 75 XF - H 90 XF, H305XE, H306XE, H307XE, H375, HURLIMANN H351, HURLIMANN XE 55 TRADITION, HURLIMANN XE F 55 TRADITION, XF 100 TRADITION, XF 90 TRADITION	2.2999.153.0, 2.2999.153.0/10, 2.2999.478.0	
<b>LUK500067300</b>	Cuscinetto pto 100 x 65 x 18 mm / Pto Bearing 100 x 65 x 18 mm		HURLIMANN H351, HURLIMANN XE 55 TRADITION, HURLIMANN XE F 55 TRADITION	2.2021.017.0	
<b>LUK410002600</b>	Cuscinetto volano 47 x 20 x 14 mm - Bearing 47 x 20 x 14 mm		H 361 - H 361 XF, H 362 - H 372, H 476 XF - H 481 XF, H 491 XF, H 55 XF - H 70 XF - H 90 XF, HURLIMANN H351, HURLIMANN XE 55 TRADITION, HURLIMANN XE F 55 TRADITION		

**KIT FRIZIONE LUK 631107510**

KIT EMBRAYAGE LUK 631107510  
 KIT CLUTCH LUK 631107510  
 KIT KUPPLUNG LUK 631107510  
 KIT EMBRAGUE LUK 631107510

Art./Ref.	Note/Note	Brand	Applicazione/Application	Rif. Orig./Orig. Ref.	Immagine/Image
<b>LUK631107510</b>	Kit tutto originale LUK composto da - Kit all LUK original consists of: - Meccanismo/Clutch Ref. 131 0229 10 - Disco avanzamento/Disc clutch 331 0184 10 - Cuscinetto/Bearing Ref. 500 0076 11	<b>HURLIMANN</b>	HURLIMANN H 4105 ELITE, HURLIMANN H 468 PRESTIGE, HURLIMANN H 468-4 CLUB, HURLIMANN H 488 T PRESTIGE, HURLIMANN XA 606 - XA 607, HURLIMANN XN 706 - XN 707, HURLIMANN XN 708 - XN 709	0.014.9424.3, 0.014.9433.3, 2.2999.475.0	

**MECCANISMO + DISCO AVANZAMENTO ORIGINALE LUK RIF. 633312310 - 633312300**

MECANISME + DISQUE AVANCEMENT ORIGINAL LUK 633312310 - 633312300  
 COVER ASSEMBLY + ORIGINAL MAIN DRIVE LUK REF. 633312310 - 633312300  
 GETRIEBE + VORSCHLEIBE LUK 633312310 - 633312300  
 MECANISMO + DISCO DE AVANCE ORIGINAL LUK REF. 633312310 - 633312300

Art./Ref.	Note/Note	Brand	Applicazione/Application	Rif. Orig./Orig. Ref.	Immagine/Image
<b>LUK633312310</b>	Kit tutto originale LUK composto da - Kit all LUK original consists of: - Meccanismo/Clutch Ref. 133 0279 10 - Disco avanzamento a 6 pale/Disc clutch 6 pairs of pads 333 0116 10 - Cuscinetto/Bearing Ref. 500 0846 30	<b>HURLIMANN</b>	HURLIMANN H 478 PRESTIGE, HURLIMANN H 478-4, HURLIMANN H 488 T PRESTIGE, HURLIMANN XT 908 - XT 909, HURLIMANN XT 910.4 - XT 910.6	0.008.4184.3, 0.014.9423.3/10, 0.016.6105.3, 2.2999.207.0, 2.2999.510.0	
<b>LUK633312300</b>	Kit tutto originale LUK composto da - Kit all LUK original consists of: - Meccanismo/Clutch Ref. 133 0279 10 - Disco avanzamento/Disc clutch 333 0117 10 - Cuscinetto/Bearing Ref. 500 0846 30		HURLIMANN H 478 PRESTIGE, HURLIMANN H 478-4, HURLIMANN H 488 T PRESTIGE, HURLIMANN XT 908 - XT 909, HURLIMANN XT 910.4 - XT 910.6	0.008.4184.3, 0.014.9423.3/10, 0.014.9431.3, 2.2999.207.0, 2.2999.510.0	
<b>LUK500084630</b>	Cuscinetto reggispinta 90,60 x 55 x 22 mm / Thrust Bearing 90,60 x 55 x 22 mm		HURLIMANN ELITE 6115 XB, HURLIMANN ELITE 6135 XB, HURLIMANN H478 PRESTIGE, HURLIMANN H478-4, HURLIMANN H488 T PRESTIGE, HURLIMANN H6115 ELITE, HURLIMANN H6135 ELITE, HURLIMANN XT 115 - XT 130, HURLIMANN XT 908, HURLIMANN XT 909, HURLIMANN XT 910.4, HURLIMANN XT 910.6, HURLIMANN XT 913	2.2999.207.0, 2.2999.510.0	







**MECCANISMO + DISCO AVANZAMENTO ORIGINALE LUK RIF. 63353510 - 635353810**

MECANISME + DISQUE AVANCEMENT ORIGINAL LUK 635353510 - 635353810

COVER ASSEMBLY + ORIGINAL MAIN DRIVE LUK REF. 635353510 - 635353810

GETRIEBE + VORSCHLEIBE LUK 635353510 - 635353810

MECANISMO + DISCO DE AVANCE ORIGINAL LUK REF. 635353510 - 635353810

Art./Ref.	Note/Note	Brand	Applicazione/Application	Rif. Orig./Orig. Ref.	Immagine/Image
<b>LUK635353510</b>	Kit tutto originale LUK composto da - Kit all LUK original consists of: - Meccanismo/Clutch Ref. 135 0284 10 - Disco avanzamento 330 mm Z24/Disc clutch 330 mm Z24 333 0215 10 - Cuscinetto/Bearing Ref. 500 0076 11	<b>HURLIMANN</b>	HURLIMANN H 478 PRESTIGE, HURLIMANN H 478-4, HURLIMANN H 488 T PRESTIGE, HURLIMANN XT 908 - XT 909, HURLIMANN XT 910.4 - XT 910.6	0.015.6381.3, 0.015.6386.3, 2.2999.475.0	  
<b>LUK635353810</b>	Kit tutto originale LUK composto da - Kit all LUK original consists of: - Meccanismo/Clutch Ref. 135 0284 10 - Disco avanzamento 350 mm Z24/Disc clutch 350 mm Z24 335 0337 10 - Cuscinetto/Bearing Ref. 500 0076 11		HURLIMANN H 478 PRESTIGE, HURLIMANN H 478-4, HURLIMANN H 488 T PRESTIGE, HURLIMANN XT 908 - XT 909, HURLIMANN XT 910.4 - XT 910.6	0.015.6328.3, 0.015.6386.3, 2.2999.475.0	  



**MECCANISMO + DISCO AVANZAMENTO ORIGINALE LUK RIF. 635353910**

MECANISME + DISQUE AVANCEMENT ORIGINAL LUK 635353910

COVER ASSEMBLY + ORIGINAL MAIN DRIVE LUK REF. 635353910

GETRIEBE + VORSCHLEIBE LUK 635353910

MECANISMO + DISCO DE AVANCE ORIGINAL LUK REF. 635353910

Art./Ref.	Note/Note	Brand	Applicazione/Application	Rif. Orig./Orig. Ref.	Immagine/Image
<b>LUK635353910</b>	Kit tutto originale LUK composto da - Kit all LUK original consists of: - Meccanismo/Clutch Ref. 135 0284 10 - Disco avanzamento 350 mm Z21/Disc clutch 350 mm Z21 335 0338 10 - Cuscinetto/Bearing Ref. 500 0076 11	<b>HURLIMANN</b>	HURLIMANN ELITE 6115 XB, HURLIMANN XT 911	0.007.7930.3/10, 0.015.6386.3, 2.2999.475.0	  



**KIT FRIZIONE LUK ORIGINALE RIF. MECCANISMO 0.014.9017.3**

KIT EMBRAYAGE LUK ORIGINAL REF. 0.014.9017.3

KIT CLUTCH ORIGINAL LUK REF. 0.014.9017.3

KIT KUPPLUNG LUK REF. 0.014.9017.3

KIT EMBRAGUE LUK ORIGINAL REF. 0.014.9017.3

Art./Ref.	Note/Note	Brand	Applicazione/Application	Rif. Orig./Orig. Ref.	Immagine/Image
<b>LUK131031210</b>	Meccanismo Frizione 12" - Luk originale	<b>HURLIMANN</b>	HURLIMANN XA 70 - XA 80, HURLIMANN XA 90, HURLIMANN XB 85 T - XB 85 TB, HURLIMANN XB 90 - XB 90 T, HURLIMANN XB MAX 85, HURLIMANN XB MAX 85 TRADITION, HURLIMANN XF 100 - XF 110, HURLIMANN XF 70 - XF 75, HURLIMANN XF 80 - XF 90, HURLIMANN XS 100 - XS 110, HURLIMANN XS 80 - XS 90, HURLIMANN XS 90.3, HURLIMANN XV 100 - XV 110, HURLIMANN XV 80 - XV 90, HURLIMANN XV 90.3	0.014.9017.3	
<b>LUK331034610</b>	Disco avanzamento 310 mm a 6 pale Luk originale - Clutch Disc Diameter 310 mm 6 pairs of pads Original Luk		HURLIMANN XA 70 - XA 80, HURLIMANN XA 90, HURLIMANN XB 85 T - XB 85 TB, HURLIMANN XB 90 - XB 90 T, HURLIMANN XB MAX 85, HURLIMANN XB MAX 85 TRADITION, HURLIMANN XF 100 - XF 110, HURLIMANN XF 70 - XF 75, HURLIMANN XF 80 - XF 90, HURLIMANN XS 100 - XS 110, HURLIMANN XS 80 - XS 90, HURLIMANN XS 90.3, HURLIMANN XV 100 - XV 110, HURLIMANN XV 80 - XV 90, HURLIMANN XV 90.3	0.014.9016.3	

**KIT FRIZIONE LUK ORIGINALE RIF. MECCANISMO 0.016.6106.3**

KIT EMBRAYAGE LUK ORIGINAL REF. 0.016.6106.3

KIT CLUTCH ORIGINAL LUK REF. 0.016.6106.3

KIT KUPPLUNG LUK REF. 0.016.6106.3

KIT EMBRAGUE LUK ORIGINAL REF. 0.016.6106.3

Art./Ref.	Note/Note	Brand	Applicazione/Application	Rif. Orig./Orig. Ref.	Immagine/Image
<b>LUK135028510</b>	Meccanismo Frizione 14" - Luk originale	<b>HURLIMANN</b>	HURLIMANN ELITE 6115 XB, HURLIMANN PRESTIGE 95TRADITION, HURLIMANN XB 85 - XB 85 T, HURLIMANN XB 85 TB, HURLIMANN XB 95 - XB 95 T, HURLIMANN XB 95 TB, HURLIMANN XT 105 - XT 110, HURLIMANN XT 85, HURLIMANN XT 908 - XT 909, HURLIMANN XT 910.4 - XT 910.6, HURLIMANN XT 911, HURLIMANN XT 95	0.016.6106.3	
<b>LUK333011610</b>	Disco avanzamento 330 mm a 6 pale Luk originale - Clutch Disc Diameter 330 mm 6 pairs of pads Original Luk		HURLIMANN ELITE 6115 XB, HURLIMANN PRESTIGE 95TRADITION, HURLIMANN XB 85 - XB 85 T, HURLIMANN XB 85 TB, HURLIMANN XB 95 - XB 95 T, HURLIMANN XB 95 TB, HURLIMANN XT 105 - XT 110, HURLIMANN XT 85, HURLIMANN XT 908 - XT 909, HURLIMANN XT 910.4 - XT 910.6, HURLIMANN XT 911, HURLIMANN XT 95	0.016.6105.3	

**KIT FRIZIONE ADATTABILE RIF. 628302415 SDF**







KIT EMBRAYAGE ADAPTABLE REF. 628302415 SDF

KIT CLUTCH ADAPTABLE REF. 628302415 SDF

KIT KUPPLUNG PASSEND ZU REF. 628302415 SDF

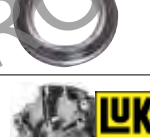
KIT EMBRAGUE ADAPTABLE REF. 628302415 SDF

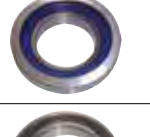
Art./Ref.	Note/Note	Brand	Applicazione/Application	Rif. Orig./Orig. Ref.	Immagine/Image
<b>85586</b>	Kit composto da - Kit consists of: - Meccanismo/Clutch Ref. 0.012.2574.4 With box Original SDF - Disco Pto/Disc Pto Ref. 0.014.9428.3 Not Original - Cuscinetto/Bearing Ref. 2.2999.478.0 Not Original - Cuscinetto/Bearing Ref. 2.2021.018.0 Not Original	<b>LAMBORGHINI</b>	600 - 660 F PLUS, 700 - 775 F PLUS, 880 F PLUS - 990 F PLUS, PLUS 100 F - 55 F - 70 F, PLUS 75 F - 90 F	0.012.2574.4, 0.012.2574.4/10, 0.014.9428.3, 0.020.3544.4, 2.2021.018.0, 2.2999.478.0	
<b>VO.012.2574.4</b>	Meccanismo Frizione 11" - Sdf originale		880 F PLUS - 990 F PLUS, CRONO 564-60, CRONO 574-70, CV 70 C - CV 70 N, CV 80 L - CV 80 M - CV 80 M, GRIMPER 555 L - N - ST, GRIMPER 560 L - N - ST - SST, GRIMPER 570 L - N - ST, PLUS 100 F, PLUS 55 F - 70 F, PLUS 75 F - 90 F	0.012.2574.4, 0.012.2574.4/10, 0.020.3543.4, 0.020.3544.4	
<b>85474</b>	Disco Pto Diametro 280 mm - Pto Disc Diameter 280 mm		880 F PLUS - 990 F PLUS, CRONO 564-60, CRONO 574-70, CV 70 C - CV 70 N, CV 80 L - CV 80 M - CV 80 M, GRIMPER 555 L - N - ST, GRIMPER 560 L - N - ST - SST, GRIMPER 570 L - N - ST, PLUS 100 F, PLUS 55 F - 70 F, PLUS 75 F - 90 F	0.014.9428.3	
<b>12841</b>	Cuscinetto reggispinta 90 x 50 x 21,60 mm / Thrust Bearing 90 x 50 x 21,60 mm		880 F PLUS - 990 F PLUS, CRONO 554-50, CRONO 564-60, CRONO 574-70, CRONO 574-75, CV 70 C - CV 70 N, CV 80 L - CV 80 M - CV 80 M, GRIMPER 555/560/570, PLUS 100 F, PLUS 55 F - 70 F, PLUS 75 F - 90 F	2.2999.153.0, 2.2999.153.0/10, 2.2999.478.0	
<b>14882</b>	Cuscinetto pto 110 x 70 x 20 mm / Pto Bearing 110 x 70 x 20 mm		880 F PLUS - 990 F PLUS, CRONO 564-60, CRONO 574-70, CV 70 C - CV 70 N, CV 80 L - CV 80 M - CV 80 M, GRIMPER 555 L - N - ST, GRIMPER 560 L - N - ST - SST, GRIMPER 570 L - N - ST, PLUS 100 F, PLUS 55 F - 70 F, PLUS 75 F - 90 F		

Art./Ref.	Note/Note	Brand	Applicazione/Application	Rif. Orig./Orig. Ref.	Immagine/Image
85587	Kit composto da - Kit consists of: - Meccanismo/Clutch Ref. 0.012.2574.4 With box Original LUK - Disco Pto/Disc Pto Ref. 0.014.9428.3 Not Original - Cuscinetto/Bearing Ref. 2.2999.478.0 Not Original Cuscinetto/Bearing Ref. 2.2021.018.0 Not Original	LAMBORGHINI	600 - 660 F PLUS, 700 - 775 F PLUS, 880 F PLUS - 990 F PLUS, PLUS 100 F - 55 F - 70 F, PLUS 75 F - 90 F	0.012.2574.4, 0.012.2574.4/10, 0.014.9428.3, 0.020.3544.4, 2.2021.018.0, 2.2999.478.0	   
85585	Meccanismo Frizione 11" - Luk originale		880 F PLUS - 990 F PLUS, CRONO 564-60, CRONO 574-70, CV 70 C - CV 70 N, CV 80 L - CV 80 M - CV 80 M, GRIMPER 555 L - N - ST, GRIMPER 560 L - N - ST - SST, GRIMPER 570 L - N - ST, PLUS 100 F, PLUS 55 F - 70 F, PLUS 75 F - 90 F	0.012.2574.4, 0.012.2574.4/10, 0.020.3543.4, 0.020.3544.4	
85474	Disco Pto Diametro 280 mm - Pto Disc Diameter 280 mm		880 F PLUS - 990 F PLUS, CRONO 564-60, CRONO 574-70, CV 70 C - CV 70 N, CV 80 L - CV 80 M - CV 80 M, GRIMPER 555 L - N - ST, GRIMPER 560 L - N - ST - SST, GRIMPER 570 L - N - ST, PLUS 100 F, PLUS 55 F - 70 F, PLUS 75 F - 90 F	0.014.9428.3	
12841	Cuscinetto reggispinta 90 x 50 x 21,60 mm / Thrust Bearing 90 x 50 x 21,60 mm		880 F PLUS - 990 F PLUS, CRONO 554-50, CRONO 564-60, CRONO 574-70, CRONO 574-75, CV 70 C - CV 70 N, CV 80 L - CV 80 M - CV 80 M, GRIMPER 555/560/570, PLUS 100 F, PLUS 55 F - 70 F, PLUS 75 F - 90 F	2.2999.153.0, 2.2999.153.0/10, 2.2999.478.0	
14882	Cuscinetto pto 110 x 70 x 20 mm / Pto Bearing 110 x 70 x 20 mm		880 F PLUS - 990 F PLUS, CRONO 564-60, CRONO 574-70, CV 70 C - CV 70 N, CV 80 L - CV 80 M - CV 80 M, GRIMPER 555 L - N - ST, GRIMPER 560 L - N - ST - SST, GRIMPER 570 L - N - ST, PLUS 100 F, PLUS 55 F - 70 F, PLUS 75 F - 90 F	2.2021.018.0	







**KIT FRIZIONE LUK 628302414**

KIT EMBRAYAGE LUK 628302414

KIT CLUTCH LUK 628302414

KIT KUPPLUNG LUK 628302414

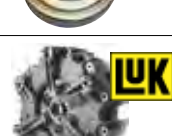
KIT EMBRAGUE LUK 628302414

Art./Ref.	Note/Note	Brand	Applicazione/Application	Rif. Orig./Orig. Ref.	Immagine/Image
LUK628302414	Kit tutto originale LUK composto da - Kit all LUK original consists of: - Meccanismo/Clutch Ref. 228 0209 11 - Disco Pto/Disc Pto 328 0377 11 - Cuscinetto/Bearing Ref. 500 0459 00 - Cuscinetto/Bearing Ref. 500 0058 10 - Cuscinetto/Bearing Ref. 410 0026 00	LAMBORGHINI	CV 70C - CV 70N, CV 80L - CV 80M, CV 80N, GRIMPER 555 L - N - ST, GRIMPER 560 L - N - SST - ST, GRIMPER 570 L - N - ST	0.012.2574.0, 0.012.2574.4, 0.012.2574.4/10, 0.014.9428.3, 0.020.3544.4, 2.2999.209.0, 2.2999.478.0	    
85585	Meccanismo Frizione 11" - Luk originale		880 F PLUS - 990 F PLUS, CRONO 564-60, CRONO 574-70, CV 70 C - CV 70 N, CV 80 L - CV 80 M - CV 80 M, GRIMPER 555 L - N - ST, GRIMPER 560 L - N - ST - SST, GRIMPER 570 L - N - ST, PLUS 100 F, PLUS 55 F - 70 F, PLUS 75 F - 90 F	0.012.2574.4, 0.012.2574.4/10, 0.020.3543.4, 0.020.3544.4	

Art./Ref.	Note/Note	Brand	Applicazione/Application	Rif. Orig./Orig. Ref.	Immagine/Image
LUK328037711	Disco Pto Diametro 280 mm Luk originale - Pto Disc Diameter 280 mm Original Luk	LAMBORGHINI	880 F PLUS - 990 F PLUS, CRONO 564-60, CRONO 574-70, CV 70 C - CV 70 N, CV 80 L - CV 80 M - CV 80 M, GRIMPER 555 L - N - ST, GRIMPER 560 L - N - ST - SST, GRIMPER 570 L - N - ST, PLUS 100 F, PLUS 55 F - 70 F, PLUS 75 F - 90 F	0.011.9073.3	
LUK500045900	Cuscinetto reggispinta 90 x 50 x 21,60 mm / Thrust Bearing 90 x 50 x 21,60 mm		880 F PLUS - 990 F PLUS, CRONO 554-50, CRONO 564-60, CRONO 574-70, CRONO 574-75, CV 70 C - CV 70 N, CV 80 L - CV 80 M - CV 80 M, GRIMPER 555/560/570, PLUS 100 F, PLUS 55 F - 70 F, PLUS 75 F - 90 F	2.2999.153.0, 2.2999.153.0/10, 2.2999.478.0	
LUK500005810	Cuscinetto pto 140 x 106 x 21 mm / Pto Bearing 140 x 106 x 21 mm		CV 70C - CV 70N, CV 80L - CV 80M, CV 80N, GRIMPER 555 L - N - ST, GRIMPER 560 L - N - SST - ST, GRIMPER 570 L - N - ST	2.2999.209.0	
LUK410002600	Cuscinetto volano 47 x 20 x 14 mm - Bearing 47 x 20 x 14 mm		600 - 660 F PLUS, 700 - 775 F PLUS, 880 F PLUS - 990 F PLUS, CV 70C - CV 70N, CV 80L - CV 80M, CV 80N, GRIMPER 555 L - N - ST, GRIMPER 560 L - N - SST - ST, GRIMPER 570 L - N - ST, PLUS 100 F - PLUS 55 F, PLUS 70 F - PLUS 75 F, PLUS 90 F		

**KIT FRIZIONE LUK 628302415**

KIT EMBRAYAGE LUK 628302415

KIT CLUTCH LUK 628302415

KIT KUPPLUNG LUK 628302415

KIT EMBRAGUE LUK 628302415

Art./Ref.	Note/Note	Brand	Applicazione/Application	Rif. Orig./Orig. Ref.	Immagine/Image
LUK628302415	Kit tutto originale LUK composto da - Kit all LUK original consists of: - Meccanismo/Clutch Ref. 228 0209 11 - Disco Pto/Disc Pto 328 0377 11 - Cuscinetto/Bearing Ref. 500 0459 00 - Cuscinetto/Bearing Ref. 500 0284 00 - Cuscinetto/Bearing Ref. 410 0026 00	LAMBORGHINI	600 - 660 F PLUS, 700 - 775 F PLUS, 880 F PLUS - 990 F PLUS, PLUS 100 F - PLUS 55 F, PLUS 70 F - PLUS 75 F, PLUS 90 F	0.012.2574.4, 0.012.2574.4/10, 0.014.9428.3, 0.020.3544.4, 2.2021.018.0, 2.2999.478.0	
85585	Meccanismo Frizione 11" - Luk originale		880 F PLUS - 990 F PLUS, CRONO 564-60, CRONO 574-70, CV 70 C - CV 70 N, CV 80 L - CV 80 M - CV 80 M, GRIMPER 555 L - N - ST, GRIMPER 560 L - N - ST - SST, GRIMPER 570 L - N - ST, PLUS 100 F, PLUS 55 F - 70 F, PLUS 75 F - 90 F	0.012.2574.4, 0.012.2574.4/10, 0.020.3543.4, 0.020.3544.4	
LUK328037711	Disco Pto Diametro 280 mm Luk originale - Pto Disc Diameter 280 mm Original Luk		880 F PLUS - 990 F PLUS, CRONO 564-60, CRONO 574-70, CV 70 C - CV 70 N, CV 80 L - CV 80 M - CV 80 M, GRIMPER 555 L - N - ST, GRIMPER 560 L - N - ST - SST, GRIMPER 570 L - N - ST, PLUS 100 F, PLUS 55 F - 70 F, PLUS 75 F - 90 F	0.011.9073.3	
LUK500045900	Cuscinetto reggispinta 90 x 50 x 21,60 mm / Thrust Bearing 90 x 50 x 21,60 mm		880 F PLUS - 990 F PLUS, CRONO 554-50, CRONO 564-60, CRONO 574-70, CRONO 574-75, CV 70 C - CV 70 N, CV 80 L - CV 80 M - CV 80 M, GRIMPER 555/560/570, PLUS 100 F, PLUS 55 F - 70 F, PLUS 75 F - 90 F	2.2999.153.0, 2.2999.153.0/10, 2.2999.478.0	
LUK500028400	Cuscinetto pto 110 x 70 x 20 mm / Pto Bearing 110 x 70 x 20 mm		880 F PLUS - 990 F PLUS, CRONO 564-60, CRONO 574-70, CV 70 C - CV 70 N, CV 80 L - CV 80 M - CV 80 M, GRIMPER 555 L - N - ST, GRIMPER 560 L - N - ST - SST, GRIMPER 570 L - N - ST, PLUS 100 F, PLUS 55 F - 70 F, PLUS 75 F - 90 F	2.2021.018.0	
LUK410002600	Cuscinetto volano 47 x 20 x 14 mm - Bearing 47 x 20 x 14 mm		600 - 660 F PLUS, 700 - 775 F PLUS, 880 F PLUS - 990 F PLUS, CV 70C - CV 70N, CV 80L - CV 80M, CV 80N, GRIMPER 555 L - N - ST, GRIMPER 560 L - N - SST - ST, GRIMPER 570 L - N - ST, PLUS 100 F - PLUS 55 F, PLUS 70 F - PLUS 75 F, PLUS 90 F		

**MECCANISMO + DISCO AVANZAMENTO ORIGINALE LUK RIF. 628313109**

MECANISME + DISQUE AVANCEMENT ORIGINAL LUK 628313109

COVER ASSEMBLY + ORIGINAL MAIN DRIVE LUK REF. 628313109

GETRIEBE + VORSCHLEIBE LUK 628313109

MECANISMO + DISCO DE AVANCE ORIGINAL LUK REF. 628313109

Art./Ref.	Note/Note	Brand	Applicazione/Application	Rif. Orig./Orig. Ref.	Immagine/Image
<b>LUK628313109</b>	Kit tutto originale LUK composto da - Kit all LUK original consists of: - Meccanismo/Clutch Ref. 128 0336 10 - Disco Avanzamento/Clutch Disc 328 0275 11	<b>LAMBORGHINI</b>	LAMBORGHINI 574-60 N CROSS, LAMBORGHINI 654-55 SPRINT, LAMBORGHINI 664-55 SPRINT, LAMBORGHINI 674-70 N CROSS, LAMBORGHINI 674-70 N CROSS BAS, LAMBORGHINI AGILE 660 S-V, LAMBORGHINI AGILE 770 S, LAMBORGHINI C635 - C65, LAMBORGHINI GRANDI PRIX 674-70, LAMBORGHINI LAMPO 55 W - 70 W, LAMBORGHINI R2.56, LAMBORGHINI R2.56 TARGET, LAMBORGHINI R2.66, LAMBORGHINI R2.66 TARGET, LAMBORGHINI R573 - R674, LAMBORGHINI RF.55 - RF.70, LAMBORGHINI RS.70 - RV.70, LAMBORGHINI SPRINT 664-60	0.015.9286.3, 0.015.9287.3, 0.270.2330.3/10	



**MECCANISMO + DISCO AVANZAMENTO ORIGINALE LUK RIF. 631308219 - 631308209**

MECANISME + DISQUE AVANCEMENT ORIGINAL LUK 631308219 - 631308209

COVER ASSEMBLY + ORIGINAL MAIN DRIVE LUK REF. 631308219 - 631308209

GETRIEBE + VORSCHLEIBE LUK 631308219 - 631308209

MECANISMO + DISCO DE AVANCE ORIGINAL LUK REF. 631308219 - 631308209

Art./Ref.	Note/Note	Brand	Applicazione/Application	Rif. Orig./Orig. Ref.	Immagine/Image
<b>LUK631308219</b>	Kit tutto originale LUK composto da - Kit all LUK original consists of: - Meccanismo/Clutch Ref. 131 0228 10 - Disco Avanzamento a 6 pale/Clutch Disc 6 pairs of pads 331 0179 11	<b>LAMBORGHINI</b>	LAMBORGHINI 654.55 SPRINT, LAMBORGHINI 664.55 SPRINT, LAMBORGHINI 674-70N, LAMBORGHINI 674-70N CROSS, LAMBORGHINI 674-70N CROSS BASS, LAMBORGHINI 774, LAMBORGHINI AGILE 660S - 770S, LAMBORGHINI AGILE 775V, LAMBORGHINI AGILE 880S - 990S, LAMBORGHINI C674-70 ERGOMATIC, LAMBORGHINI C75, LAMBORGHINI C774-80 ERGOMATIC, LAMBORGHINI C874-90 ERGOMATIC, LAMBORGHINI CF100L - CF100N, LAMBORGHINI CF78L - CF78ST, LAMBORGHINI CF78N, LAMBORGHINI CF80N - CF80ST, LAMBORGHINI CF88L - CF88N, LAMBORGHINI CF88ST, LAMBORGHINI CF90L - CF90N, LAMBORGHINI CF90ST, LAMBORGHINI CF98L - CF98N, LAMBORGHINI CF98ST, LAMBORGHINI CROSS 674-75N, LAMBORGHINI GRAND PRIX 674-70, LAMBORGHINI GRAND PRIX 75TARGE, LAMBORGHINI GRAND PRIX 774-80, LAMBORGHINI GRAND PRIX 874-90T, LAMBORGHINI R2.76 - R2.76TARGE, LAMBORGHINI R2.86 - R2.86TARGE, LAMBORGHINI R3.75, LAMBORGHINI R3.75T - R3.75TB, LAMBORGHINI RF.100 - RF.55, LAMBORGHINI RF.70 - RF.75, LAMBORGHINI RF.90, LAMBORGHINI RS.100 - RS.70, LAMBORGHINI RS.75 - RS.90, LAMBORGHINI RV.100 - RV.70, LAMBORGHINI RV.75 - RV.90, LAMBORGHINI SPRINT 674-70, LAMBORGHINI SPRINT 675-75, LAMBORGHINI SPRINT 684-85, LAMBORGHINI TRIUMPH 80 - 90	0.015.9285.3, 0.015.9289.3	
<b>LUK631308209</b>	Kit tutto originale LUK composto da - (it al LUK original consists of: - Meccanismo/Clutch Ref. 131 0228 10 - Disco Avanzamento/Clutch Disc 331 0179 10		LAMBORGHINI 654.55 SPRINT, LAMBORGHINI 664.55 SPRINT, LAMBORGHINI 674-70N, LAMBORGHINI 674-70N CROSS, LAMBORGHINI 674-70N CROSS BASS, LAMBORGHINI 774, LAMBORGHINI AGILE 660S - 770S, LAMBORGHINI AGILE 775V, LAMBORGHINI AGILE 880S - 990S, LAMBORGHINI C674-70 ERGOMATIC, LAMBORGHINI C75, LAMBORGHINI C774-80 ERGOMATIC, LAMBORGHINI C874-90 ERGOMATIC, LAMBORGHINI CF100L - CF100N, LAMBORGHINI CF78L - CF78ST, LAMBORGHINI CF78N, LAMBORGHINI CF80N - CF80ST, LAMBORGHINI CF88L - CF88N, LAMBORGHINI CF88ST, LAMBORGHINI CF90L - CF90N, LAMBORGHINI CF90ST, LAMBORGHINI CF98L - CF98N, LAMBORGHINI CF98ST, LAMBORGHINI CROSS 674-75N, LAMBORGHINI GRAND PRIX 674-70, LAMBORGHINI GRAND PRIX 75TARGE, LAMBORGHINI GRAND PRIX 774-80, LAMBORGHINI GRAND PRIX 874-90T, LAMBORGHINI R2.76 - R2.86TARGE, LAMBORGHINI R3.75, LAMBORGHINI R3.75T - R3.75TB, LAMBORGHINI RF.100 - RF.55, LAMBORGHINI RF.70 - RF.75, LAMBORGHINI RF.90, LAMBORGHINI RS.100 - RS.70, LAMBORGHINI RS.75 - RS.90, LAMBORGHINI RV.100 - RV.70, LAMBORGHINI RV.75 - RV.90, LAMBORGHINI SPRINT 674-70, LAMBORGHINI SPRINT 675-75, LAMBORGHINI SPRINT 684-85, LAMBORGHINI TRIUMPH 80 - 90	0.015.9285.3, 0.015.9288.3	



**MECCANISMO + DISCO AVANZAMENTO ORIGINALE LUK RIF. 633303109**

MECANISME + DISQUE AVANCEMENT ORIGINAL LUK 633303109

COVER ASSEMBLY + ORIGINAL MAIN DRIVE LUK REF. 633303109

GETRIEBE + VORSCHLEIBE LUK 633303109

MECANISMO + DISCO DE AVANCE ORIGINAL LUK 633303109

Art./Ref.	Note/Note	Brand	Applicazione/Application	Rif. Orig./Orig. Ref.	Immagine/Image
LUK633303109	Kit tutto originale LUK composto da - Kit all LUK original consists of: - Meccanismo/Clutch Ref. 133 0259 10 - Disco Avanzamento a 5 pale/Clutch Disc 5 pairs of pads 333 0186 10	LAMBORGHINI	LAMBORGHINI C.100 - C.105, LAMBORGHINI C.90 - C.95, LAMBORGHINI R3 EVO 100, LAMBORGHINI R3.75 - R3.85, LAMBORGHINI R3.95, LAMBORGHINI R4.105 - R4.110, LAMBORGHINI R4.85 - R4.95, LAMBORGHINI TRIUMPH 100	0.012.7094.3, 0.012.7095.3/10	

**MECCANISMO + DISCO AVANZAMENTO ORIGINALE LUK RIF. 635304509**

MECANISME + DISQUE AVANCEMENT ORIGINAL LUK 635304509

COVER ASSEMBLY + ORIGINAL MAIN DRIVE LUK REF. 635304509

GETRIEBE + VORSCHLEIBE LUK 635304509

MECANISMO + DISCO DE AVANCE ORIGINAL LUK 635304509

Art./Ref.	Note/Note	Brand	Applicazione/application	Rif. Orig./Orig. Ref.	Immagine/Image
LUK635304509	Kit tutto originale LUK composto da - Kit all LUK original consists of: - Meccanismo/Clutch Ref. 135 0241 10 - Disco Avanzamento a 6 pale/Clutch Disc 6 pairs of pads 335 0186 10	LAMBORGHINI	LAMBORGHINI FORMULA 135, LAMBORGHINI PREMIUM 1300, LAMBORGHINI R5.115 - R5.130	0.008.5595.3, 0.008.5596.3	
LUK500084630	Cuscinetto reggispinta 90,60 x 55 x 22 mm / Thrust Bearing 90,60 x 55 x 22 mm		LAMBORGHINI 1106, LAMBORGHINI 1306, LAMBORGHINI 1506, LAMBORGHINI 774-80N, LAMBORGHINI 956, LAMBORGHINI FORMULA 105, LAMBORGHINI FORMULA 115, LAMBORGHINI FORMULA 135, LAMBORGHINI GRAND-PRIX 774-80, LAMBORGHINI GRAND-PRIX 874-90T, LAMBORGHINI PREMIUM 1050, LAMBORGHINI PREMIUM 1060, LAMBORGHINI PREMIUM 1300, LAMBORGHINI PREMIUM 850, LAMBORGHINI PREMIUM 950, LAMBORGHINI R5.115 - R5.130	2.2999.207.0, 2.2999.510.0	

**MECCANISMO + DISCO AVANZAMENTO ORIGINALE LUK RIF. 635351009**

MECANISME + DISQUE AVANCEMENT ORIGINAL LUK 635351009

COVER ASSEMBLY + ORIGINAL MAIN DRIVE LUK REF. 635351009

GETRIEBE + VORSCHLEIBE LUK 635351009

MECANISMO + DISCO DE AVANCE ORIGINAL LUK 635351009

Art./Ref.	Note/Note	Brand	Applicazione/Application	Rif. Orig./Orig. Ref.	Immagine/Image
LUK635351009	Kit tutto originale LUK composto da - Kit all LUK original consists of: - Meccanismo/Clutch Ref. 135 0279 10 - Disco Avanzamento a 7 pale/Clutch Disc 7 pairs of pads 335 0321 10	LAMBORGHINI	LAMBORGHINI 1106 - 1306 - 1506, LAMBORGHINI 1706 - 956 - R1056, LAMBORGHINI R1106 - R1156, LAMBORGHINI R1256 - R1306, LAMBORGHINI R1356 - R1506, LAMBORGHINI R1556 - R906	0.014.0175.4, 0.014.0176.3	
LUK500059730	Cuscinetto reggispinta completo 111 x 65 x 30 mm / Bearing + carrier assy 111 x 65 x 30 mm		R 1306, R 1506	0.250.6533.3, 0.264.6533.3/20	
LUK500084630	Cuscinetto reggispinta 90,60 x 55 x 22 mm / Thrust Bearing 90,60 x 55 x 22 mm		LAMBORGHINI 1106, LAMBORGHINI 1306, LAMBORGHINI 1506, LAMBORGHINI 774-80N, LAMBORGHINI 956, LAMBORGHINI FORMULA 105, LAMBORGHINI FORMULA 115, LAMBORGHINI FORMULA 135, LAMBORGHINI GRAND-PRIX 774-80, LAMBORGHINI GRAND-PRIX 874-90T, LAMBORGHINI PREMIUM 1050, LAMBORGHINI PREMIUM 1060, LAMBORGHINI PREMIUM 1300, LAMBORGHINI PREMIUM 850, LAMBORGHINI PREMIUM 950, LAMBORGHINI R5.115 - R5.130	2.2999.207.0, 2.2999.510.0	

**KIT FRIZIONE LUK 625300710**

KIT EMBRAYAGE LUK 625300710

KIT CLUTCH LUK 625300710

KIT KUPPLUNG LUK 625300710

KIT EMBRAGUE LUK 625300710

Art./Ref.	Note/Note	Brand	Applicazione/Application	Rif. Orig./Orig. Ref.	Immagine/Image
<b>LUK625300710</b>	Kit tutto originale LUK composto da - Kit all LUK original consists of: - Meccanismo/Clutch Ref. 225 0055 10 - Disco Pto/Disc Pto 323 0556 10 - Cuscinetto/Bearing Ref. 500 0459 00 - Cuscinetto/Bearing Ref. 500 0673 00 - Cuscinetto/Bearing Ref. 410 0026 00	<b>LAMBORGHINI</b>	LAMBORGHINI CRONO 55 TARGET, LAMBORGHINI CRONO F 55 TARGET	0.008.4743.4 0.008.4744.3, 0.011.9063.3, 0.012.2564.4, 2.2021.018.0, 2.2999.153.0/10, 2.2999.478.0	
<b>LUK500045900</b>	Cuscinetto reggispira 90 x 50 x 21,60 mm / Thrust Bearing 90 x 50 x 21,60 mm		880 F PLUS - 990 F PLUS, CRONO 554-50, CRONO 564-60, CRONO 574-70, CRONO 574-75, CV 70 C - CV 70 N, CV 80 L - CV 80 M - CV 80 M, GRIMPER 555/560/570, LAMBORGHINI CRONO 55 TARGET, LAMBORGHINI CRONO F 55 TARGET, PLUS 100 F, PLUS 55 F - 70 F, PLUS 75 F - 90 F	2.2999.153.0, 2.2999.153.0/10, 2.2999.478.0	
<b>LUK500067300</b>	Cuscinetto pto 100 x 65 x 18 mm / Pto Bearing 100 x 65 x 18 mm		LAMBORGHINI CRONO 55 TARGET, LAMBORGHINI CRONO F 55 TARGET	2.2021.017.0	
<b>LUK410002600</b>	Cuscinetto volano 47 x 20 x 14 mm - Bearing 47 x 20 x 14 mm		600 - 660 F PLUS, 700 - 775 F PLUS, 880 F PLUS - 990 F PLUS, CV 70C - CV 70N, CV 80L - CV 80M, CV 80N, GRIMPER 555 L - N - ST, GRIMPER 560 L - N - SST - ST, GRIMPER 570 L - N - ST, LAMBORGHINI CRONO 55 TARGET, LAMBORGHINI CRONO F 55 TARGET, PLUS 100 F - PLUS 55 F, PLUS 70 F - PLUS 75 F - PLUS 90 F		

**KIT FRIZIONE LUK 631107510**

KIT EMBRAYAGE LUK 631107510

KIT CLUTCH LUK 631107510

KIT KUPPLUNG LUK 631107510

KIT EMBRAGUE LUK 631107510

Art./Ref.	Note/Note	Brand	Applicazione/Application	Rif. Orig./Orig. Ref.	Immagine/Image
<b>LUK631107510</b>	Kit tutto originale LUK composto da - Kit all LUK original consists of: - Meccanismo/Clutch Ref. 131 0229 10 - Disco avanzamento/Disc clutch 331 0184 10 - Cuscinetto/Bearing Ref. 500 0076 11	<b>LAMBORGHINI</b>	LAMBORGHINI 574-60 N CROSS, LAMBORGHINI 674-60 N, LAMBORGHINI 674-60 N CROSS, LAMBORGHINI 674-60 N CROSS BAS, LAMBORGHINI AGILE 660S, LAMBORGHINI AGILE 770S, LAMBORGHINI AGILE 880S, LAMBORGHINI AGILE 990S, LAMBORGHINI C874-90 ERGOMATIC, LAMBORGHINI FORMULA 105, LAMBORGHINI GRAND PRIX 674-70, LAMBORGHINI GRAND PRIX 874-90T, LAMBORGHINI SPRINT 664-60, LAMBORGHINI SPRINT 674-70	0.014.9424.3, 0.014.9433.3, 2.2999.475.0	

**MECCANISMO + DISCO AVANZAMENTO ORIGINALE LUK RIF. 633312310 - 633312300**

MECANISME + DISQUE AVANCEMENT ORIGINAL LUK 633312310 - 633312300

COVER ASSEMBLY + ORIGINAL MAIN DRIVE LUK REF. 633312310 - 633312300

GETRIEBE + VORSCHLEIBE LUK 633312310 - 633312300

MECANISMO + DISCO DE AVANCE ORIGINAL LUK REF. 633312310 - 633312300

Art./Ref.	Note/Note	Brand	Applicazione/Application	Rif. Orig./Orig. Ref.	Immagine/Image
<b>LUK633312310</b>	Kit tutto originale LUK composto da - Kit all LUK original consists of: - Meccanismo/Clutch Ref. 133 0279 10 - Disco avanzamento a 6 pale/Disc clutch 6 pairs of pads 333 0116 10 - Cuscinetto/Bearing Ref. 500 0846 30	<b>LAMBORGHINI</b>	LAMBORGHINI 774-80 N, LAMBORGHINI FORMULA 105 - 135, LAMBORGHINI GRAND PRIX 774-80, LAMBORGHINI GRAND PRIX 874-90T, LAMBORGHINI PREMIUM 1050, LAMBORGHINI PREMIUM 1060, LAMBORGHINI PREMIUM 850 - 950	0.008.4184.3, 0.014.9423.3/10, 0.016.6105.3, 2.2999.207.0, 2.2999.510.0	
<b>LUK633312300</b>	Kit tutto originale LUK composto da - Kit all LUK original consists of: - Meccanismo/Clutch Ref. 133 0279 10 - Disco avanzamento/Disc clutch 333 0117 10 - Cuscinetto/Bearing Ref. 500 0846 30		LAMBORGHINI 774-80 N, LAMBORGHINI FORMULA 105 - 135, LAMBORGHINI GRAND PRIX 774-80, LAMBORGHINI GRAND PRIX 874-90T, LAMBORGHINI PREMIUM 1050, LAMBORGHINI PREMIUM 1060, LAMBORGHINI PREMIUM 850 - 950	0.008.4184.3, 0.014.9423.3/10, 0.014.9431.3, 2.2999.207.0, 2.2999.510.0	
<b>LUK500084630</b>	Cuscinetto reggispinta 90,60 x 55 x 22 mm / Thrust Bearing 90,60 x 55 x 22 mm		LAMBORGHINI 1106, LAMBORGHINI 1306, LAMBORGHINI 1506, LAMBORGHINI 774-80N, LAMBORGHINI 956, LAMBORGHINI FORMULA 105, LAMBORGHINI FORMULA 115, LAMBORGHINI FORMULA 135, LAMBORGHINI GRAND-PRIX 774-80, LAMBORGHINI GRAND-PRIX 874-90T, LAMBORGHINI PREMIUM 1050, LAMBORGHINI PREMIUM 1060, LAMBORGHINI PREMIUM 1300, LAMBORGHINI PREMIUM 850, LAMBORGHINI PREMIUM 950, LAMBORGHINI R5.115 - R5.130	2.2999.207.0, 2.2999.510.0	

**MECCANISMO + DISCO AVANZAMENTO ORIGINALE LUK RIF. 635353510 - 635353810**

MECANISME + DISQUE AVANCEMENT ORIGINAL LUK 635353510 - 635353810

COVER ASSEMBLY + ORIGINAL MAIN DRIVE LUK REF. 635353510 - 635353810

GETRIEBE + VORSCHLEIBE LUK 635353510 - 635353810

MECANISMO + DISCO DE AVANCE ORIGINAL LUK REF. 635353510 - 635353810

Art./Ref.	Note/Note	Brand	Applicazione/Application	Rif. Orig./Orig. Ref.	Immagine/Image
<b>LUK635353510</b>	Kit tutto originale LUK composto da - Kit all LUK original consists of: - Meccanismo/Clutch Ref. 135 0284 10 - Disco avanzamento 330 mm Z24/Disc clutch 330 mm Z24 333 0215 10 - Cuscinetto/Bearing Ref. 500 0076 11	<b>LAMBORGHINI</b>	LAMBORGHINI 774-80N, LAMBORGHINI GRAND PRIX 774-80, LAMBORGHINI GRAND PRIX 874-90T, LAMBORGHINI PREMIUM 1050, LAMBORGHINI PREMIUM 1060, LAMBORGHINI PREMIUM 850 - 950	0.015.6381.3, 0.015.6386.3, 2.2999.475.0	
<b>LUK635353810</b>	Kit tutto originale LUK composto da - Kit all LUK original consists of: - Meccanismo/Clutch Ref. 135 0284 10 - Disco avanzamento 350 mm Z24/Disc clutch 350 mm Z24 335 0337 10 - Cuscinetto/Bearing Ref. 500 0076 11		LAMBORGHINI 774-80N, LAMBORGHINI GRAND PRIX 774-80, LAMBORGHINI GRAND PRIX 874-90T, LAMBORGHINI PREMIUM 1050, LAMBORGHINI PREMIUM 1060, LAMBORGHINI PREMIUM 850 - 950	0.015.6328.3, 0.015.6386.3, 2.2999.475.0	

**MECCANISMO + DISCO AVANZAMENTO ORIGINALE LUK RIF. 635353910**

MECANISME + DISQUE AVANCEMENT ORIGINAL LUK 635353910

COVER ASSEMBLY + ORIGINAL MAIN DRIVE LUK REF. 635353910

GETRIEBE + VORSCHLEIBE LUK 635353910

MECANISMO + DISCO DE AVANCE ORIGINAL LUK REF. 635353910

Art./Ref.	Note/Note	Brand	Applicazione/Application	Rif. Orig./Orig. Ref.	Immagine/Image
LUK635353910	Kit tutto originale LUK composto da - Kit all LUK original consists of: - Meccanismo/Clutch Ref. 135 0284 10 - Disco avanzamento 350 mm Z21/Disc clutch 350 mm Z21 335 0338 10 - Cuscinetto/Bearing Ref. 500 0076 11	LAMBORGHINI	LAMBORGHINI FORMULA 115, LAMBORGHINI PREMIUM 1100	0.007.7930.3/10, 0.015.6386.3, 2.2999.475.0	

**KIT FRIZIONE LUK ORIGINALE RIF. MECCANISMO 0.014.9017.3**

KIT EMBRAYAGE LUK ORIGINAL REF. 0.014.9017.3

KIT CLUTCH ORIGINAL LUK REF. 0.014.9017.3

KIT KUPPLUNG LUK REF. 0.014.9017.3

KIT EMBRAGUE LUK ORIGINAL REF. 0.014.9017.3

Art./Ref.	Note/Note	Brand	Applicazione/Application	Rif. Orig./Orig. Ref.	Immagine/Image
LUK131031210	Meccanismo Frizione 12" - Luk originale	LAMBORGHINI	LAMBORGHINI R 3 EVO 85	0.014.9017.3	
LUK331034610	Disco avanzamento 310 mm a 6 pale Luk originale - Clutch Disc Diameter 310 mm 6 pairs of pads Original Luk		LAMBORGHINI R 3 EVO 85	0.014.9016.3	

**KIT FRIZIONE LUK ORIGINALE RIF. MECCANISMO 0.016.6106.3**

KIT EMBRAYAGE LUK ORIGINAL REF. 0.016.6106.3

KIT CLUTCH ORIGINAL LUK REF. 0.016.6106.3

KIT KUPPLUNG LUK REF. 0.016.6106.3

KIT EMBRAGUE LUK ORIGINAL REF. 0.016.6106.3

Art./Ref.	Note/Note	Brand	Applicazione/Application	Rif. Orig./Orig. Ref.	Immagine/Image
LUK135028510	Meccanismo Frizione 14" - Luk originale	LAMBORGHINI	LAMBORGHINI CROSS 774-85 N, LAMBORGHINI CROSS 874-95 N, LAMBORGHINI FORMULA 115, LAMBORGHINI GRAND PRIX 95 TARG, LAMBORGHINI HIGH CLEARANCE 90, LAMBORGHINI PREMIUM 1100, LAMBORGHINI R3.75 - R3.85, LAMBORGHINI R3.85 T - R3.85 TB, LAMBORGHINI R3.95 - R3.95 T, LAMBORGHINI R3.95 TB, LAMBORGHINI R4.105, LAMBORGHINI R4.110 - R4.85, LAMBORGHINI R4.95	0.016.6106.3	
LUK333011610	Disco avanzamento 330 mm a 6 pale Luk originale - Clutch Disc Diameter 330 mm 6 pairs of pads Original Luk		LAMBORGHINI CROSS 774-85 N, LAMBORGHINI CROSS 874-95 N, LAMBORGHINI FORMULA 115, LAMBORGHINI GRAND PRIX 95 TARG, LAMBORGHINI HIGH CLEARANCE 90, LAMBORGHINI PREMIUM 1100, LAMBORGHINI R3.75 - R3.85, LAMBORGHINI R3.85 T - R3.85 TB, LAMBORGHINI R3.95 - R3.95 T, LAMBORGHINI R3.95 TB, LAMBORGHINI R4.105, LAMBORGHINI R4.110 - R4.85, LAMBORGHINI R4.95	0.016.6105.3	

**KIT FRIZIONE ADATTABILE RIF. 628302415 SDF**

KIT EMBRAYAGE ADAPTABLE REF. 628302415 SDF

KIT CLUTCH ADAPTABLE REF. 628302415 SDF

KIT KUPPLUNG PASSEND ZU REF. 628302415 SDF

KIT EMBRAGUE ADAPTABLE REF. 628302415 SDF

Art./Ref.	Note/Note	Brand	Applicazione/Application	Rif. Orig./Orig. Ref.	Immagine/Image
<b>85586</b>	Kit composto da - Kit consists of: - Meccanismo/Clutch Ref. 0.012.2574.4 With box Original SDF - Disco Pto/Disc Pto Ref. 0.014.9428.3 Not Original - Cuscinetto/Bearing Ref. 2.2999.478.0 Not Original - Cuscinetto/Bearing Ref. 2.2021.018.0 Not Original	SAME	ASTER 60 - 70, FRUTTETO II 100, FRUTTETO II 55, FRUTTETO II 60, FRUTTETO II 70, FRUTTETO II 75, FRUTTETO II 85, FRUTTETO II 90, SOLAR 60	0.012.2574.4, 0.012.2574.4/10 0.014.9428.3, 0.020.3544.4, 2.2021.018.0, 2.2999.478.0	   
<b>VO.012.2574.4</b>	Meccanismo Frizione 11" - Sdf originale		ARGON 60 - 70, FRUTTETO II 100, FRUTTETO II 55, FRUTTETO II 70, FRUTTETO II 75, FRUTTETO II 85, FRUTTETO II 90, FRUTTETO III 100 CLASSIC, FRUTTETO III 90 CLASSIC, KRYPTON V 70 C, KRYPTON V 70 N, KRYPTON V 80 L, KRYPTON V 80 M, KRYPTON V 80 N, ROCK 55, ROCK 60, ROCK 70	0.012.2574.4, 0.012.2574.4/10, 0.020.3543.4, 0.020.3544.4	
<b>85474</b>	Disco Pto Diametro 280 mm - Pto Disc Diameter 280 mm		ARGON 60 - 70, FRUTTETO II 100, FRUTTETO II 55, FRUTTETO II 70, FRUTTETO II 75, FRUTTETO II 85, FRUTTETO II 90, FRUTTETO III 100 CLASSIC, FRUTTETO III 90 CLASSIC, KRYPTON V 70 C, KRYPTON V 70 N, KRYPTON V 80 L, KRYPTON V 80 M, KRYPTON V 80 N, ROCK 55, ROCK 60, ROCK 70	0.014.9428.3	
<b>12841</b>	Cuscinetto reggispira 90 x 50 x 21,60 mm / Thrust Bearing 90 x 50 x 21,60 mm		ARGON 50/55/55F/60/70/75F/70CL, ASTER 60/70, FRUTTETO 60/75, FRUTTETO 60II/75II/85II, KRYPTON V70/V80, ROCK 55/60/70	2.299.153.0/1, 2.2999.153.0, 2.2999.153.0/1, 2.2999.153.0/10, 2.2999.478.0	
<b>14882</b>	Cuscinetto pto 110 x 70 x 20 mm / Pto Bearing 110 x 70 x 20 mm		ASTER 60 - 70, FRUTTETO II 100, FRUTTETO II 55, FRUTTETO II 70, FRUTTETO II 75, FRUTTETO II 85, FRUTTETO II 90, LEOPARD 85 C, SOLAR 50 - 55 C - 60 - 60 C, SOLAR 60 COMPACT HD	2.2021.018.0	
<b>85587</b>	Kit composto da - Kit consists of: - Meccanismo/Clutch Ref. 0.012.2574.4 With box Original LUK - Disco Pto/Disc Pto Ref. 0.014.9428.3 Not Original - Cuscinetto/Bearing Ref. 2.2999.478.0 Not Original - Cuscinetto/Bearing Ref. 2.2021.018.0 Not Original		SAME	ASTER 60 - 70, FRUTTETO II 100, FRUTTETO II 55, FRUTTETO II 60, FRUTTETO II 70, FRUTTETO II 75, FRUTTETO II 85, FRUTTETO II 90, SOLAR 60	0.012.2574.4, 0.012.2574.4/10, 0.014.9428.3, 0.020.3544.4, 2.2021.018.0, 2.2999.478.0

Art./Ref.	Note/Note	Brand	Applicazione/Application	Rif. Orig./Orig. Ref.	Immagine/Image
85585	Meccanismo Frizione 11" - Luk originale	SAME	ARGON 60 - 70, FRUTTETO II 100, FRUTTETO II 55, FRUTTETO II 70, FRUTTETO II 75, FRUTTETO II 85, FRUTTETO II 90, FRUTTETO III 100 CLASSIC, FRUTTETO III 90 CLASSIC, KRYPTON V 70 C, KRYPTON V 70 N, KRYPTON V 80 L, KRYPTON V 80 M, KRYPTON V 80 N, ROCK 55, ROCK 60, ROCK 70	0.012.2574.4, 0.012.2574.4/10, 0.020.3543.4, 0.020.3544.4	
85474	Disco Pto Diametro 280 mm / Pto Disc Diameter 280 mm		ARGON 60 - 70, FRUTTETO II 100, FRUTTETO II 55, FRUTTETO II 70, FRUTTETO II 75, FRUTTETO II 85, FRUTTETO II 90, FRUTTETO III 100 CLASSIC, FRUTTETO III 90 CLASSIC, KRYPTON V 70 C, KRYPTON V 70 N, KRYPTON V 80 L, KRYPTON V 80 M, KRYPTON V 80 N, ROCK 55, ROCK 60, ROCK 70	0.014.9428.3	
12841	Cuscinetto reggispinta 90 x 50 x 21,60 mm / Thrust Bearing 90 x 50 x 21,60 mm		ARGON 50/55/55F/60/70/75F/70CL, ASTER 60/70, FRUTTETO 60/75, FRUTTETO 60II/75II/85II, KRYPTON V70/V80, ROCK 55/60/70	2.299.153.0/1, 2.2999.153.0, 2.2999.153.0/1, 2.2999.153.0/10, 2.2999.478.0	
14882	Cuscinetto pto 110 x 70 x 20 mm / Pto Bearing 110 x 70 x 20 mm		ASTER 60 - 70, FRUTTETO II 100, FRUTTETO II 55, FRUTTETO II 70, FRUTTETO II 75, FRUTTETO II 85, FRUTTETO II 90, LEOPARD 85 C, SOLAR 50 - 55 C - 60 - 60 C, SOLAR 60 COMPACT HD	2.2021.018.0	

**KIT FRIZIONE LUK 628302414**

KIT EMBRAYAGE LUK 628302414

KIT CLUTCH LUK 628302414

KIT KUPPLUNG LUK 628302414

KIT EMBRAGUE LUK 628302414

Art./Ref.	Note/Note	Brand	Applicazione/Application	Rif. Orig./Orig. Ref.	Immagine/Image
LUK628302414	Kit tutto originale LUK composto da - Kit all LUK original consists of: - Meccanismo/Clutch Ref. 228 0209 11 - Disco Pto/Disc Pto 328 0377 11 - Cuscinetto/Bearing Ref. 500 0459 00 - Cuscinetto/Bearing Ref. 500 0058 10 - Cuscinetto/Bearing Ref. 410 0026 00	SAME	FRUTTETO 60 - 75, KRYPTON V 70 C - N, KRYPTON V 80 L - M - N, ROCK 55 - 60 - 70, VIGNERON 62 - 75	0.012.2574.0, 0.012.2574.4, 0.012.2574.4/10, 0.014.9428.3, 0.020.3544.4, 2.2999.209.0, 2.2999.478.0	   
85585	Meccanismo Frizione 11" - Luk originale		ARGON 60 - 70, FRUTTETO II 100, FRUTTETO II 55, FRUTTETO II 70, FRUTTETO II 75, FRUTTETO II 85, FRUTTETO II 90, FRUTTETO III 100 CLASSIC, FRUTTETO III 90 CLASSIC, KRYPTON V 70 C, KRYPTON V 70 N, KRYPTON V 80 L, KRYPTON V 80 M, KRYPTON V 80 N, ROCK 55, ROCK 60, ROCK 70	0.012.2574.4, 0.012.2574.4/10, 0.020.3543.4, 0.020.3544.4	
LUK328037711	Disco Pto Diametro 280 mm Luk originale - Pto Disc Diameter 280 mm Original Luk		ARGON 60 - 70, FRUTTETO II 100, FRUTTETO II 55, FRUTTETO II 70, FRUTTETO II 75, FRUTTETO II 85, FRUTTETO II 90, FRUTTETO III 100 CLASSIC, FRUTTETO III 90 CLASSIC, KRYPTON V 70 C, KRYPTON V 70 N, KRYPTON V 80 L, KRYPTON V 80 M, KRYPTON V 80 N, ROCK 55, ROCK 60, ROCK 70	0.011.9073.3	
LUK500045900	Cuscinetto reggispinta 90 x 50 x 21,60 mm / Thrust Bearing 90 x 50 x 21,60 mm		ARGON 50/55/55F/60/70/75F/70CL, ASTER 60/70, FRUTTETO 60/75, FRUTTETO 60II/75II/85II, KRYPTON V70/V80, ROCK 55/60/70	2.299.153.0/1, 2.2999.153.0, 2.2999.153.0/1, 2.2999.153.0/10, 2.2999.478.0	

Art./Ref.	Note/Note	Brand	Applicazione/Application	Rif. Orig./Orig. Ref.	Immagine/Image
LUK500005810	Cuscinetto pto 140 x 106 x 21 mm / Pto Bearing 140 x 106 x 21 mm	SAME	FRUTTETO 60 - 75, KRYPTON V 70 C - N, KRYPTON V 80 L - M - N, ROCK 55 - 60 - 70, VIGNERON 62 - 75	2.2999.209.0	
LUK410002600	Cuscinetto volano 47 x 20 x 14 mm - Bearing 47 x 20 x 14 mm		ASTER 60 - 70, FRUTTETO 60 - 75, FRUTTETO II 100, FRUTTETO II 55, FRUTTETO II 60, FRUTTETO II 70, FRUTTETO II 75, FRUTTETO II 85, FRUTTETO II 90, KRYPTON V 70 C - N, KRYPTON V 80 L - M - N, ROCK 55 - 60 - 70, SOLAR 60, VIGNERON 62 - 75		



**KIT FRIZIONE LUK 628302415**

- KIT EMBRAYAGE LUK 628302415
- KIT CLUTCH LUK 628302415
- KIT KUPPLUNG LUK 628302415
- KIT EMBRAGUE LUK 628302415

Art./Ref.	Note/Note	Brand	Applicazione/Application	Rif. Orig./Orig. Ref.	Immagine/Image
LUK628302415	Kit tutto originale LUK composto da - Kit all LUK original consists of: - Meccanismo/Clutch Ref. 228 0209 11 - Disco Pto/Disc Pto 328 0377 11 - Cuscinetto/Bearing Ref. 500 0459 00 - Cuscinetto/Bearing Ref. 500 0284 00 - Cuscinetto/Bearing Ref. 410 0026 00	SAME	ASTER 60 - 70, FRUTTETO II 100, FRUTTETO II 55, FRUTTETO II 60, FRUTTETO II 70, FRUTTETO II 75, FRUTTETO II 85, FRUTTETO II 90, SOLAR 60	0.012.2574.4, 0.012.2574.4/10, 0.014.9428.3, 0.020.3544.4, 2.2021.018.0, 2.2999.478.0	
85585	Meccanismo Frizione 11" - Luk originale		ARGON 60 - 70, FRUTTETO II 100, FRUTTETO II 55, FRUTTETO II 70, FRUTTETO II 75, FRUTTETO II 85, FRUTTETO II 90, FRUTTETO III 100 CLASSIC, FRUTTETO III 90 CLASSIC, KRYPTON V 70 C, KRYPTON V 70 N, KRYPTON V 80 L, KRYPTON V 80 M, KRYPTON V 80 N, ROCK 55, ROCK 60, ROCK 70	0.012.2574.4, 0.012.2574.4/10, 0.020.3543.4, 0.020.3544.4	
LUK328037711	Disco Pto Diametro 280 mm Luk originale - Pto Disc Diameter 280 mm Original Luk		ARGON 60 - 70, FRUTTETO II 100, FRUTTETO II 55, FRUTTETO II 70, FRUTTETO II 75, FRUTTETO II 85, FRUTTETO II 90, FRUTTETO III 100 CLASSIC, FRUTTETO III 90 CLASSIC, KRYPTON V 70 C, KRYPTON V 70 N, KRYPTON V 80 L, KRYPTON V 80 M, KRYPTON V 80 N, ROCK 55, ROCK 60, ROCK 70	0.011.9073.3	
LUK500045900	Cuscinetto reggispinta 90 x 50 x 21,60 mm / Thrust Bearing 90 x 50 x 21,60 mm		ARGON 50/55/55F/60/70/75F/70CL, ASTER 60/70, FRUTTETO 60/75, FRUTTETO 60II/75II/85II, KRYPTON V70/V80, ROCK 55/60/70	2.299.153.0/1, 2.2999.153.0, 2.2999.153.0/1, 2.2999.153.0/10, 2.2999.478.0	
LUK500028400	Cuscinetto pto 110 x 70 x 20 mm / Pto Bearing 110 x 70 x 20 mm		ASTER 60 - 70, FRUTTETO II 100, FRUTTETO II 55	2.2021.018.0	
LUK410002600	Cuscinetto volano 47 x 20 x 14 mm - Bearing 47 x 20 x 14 mm		ASTER 60 - 70, FRUTTETO 60 - 75, FRUTTETO II 100, FRUTTETO II 55, FRUTTETO II 60, FRUTTETO II 70, FRUTTETO II 75, FRUTTETO II 85, FRUTTETO II 90, KRYPTON V 70 C - N, KRYPTON V 80 L - M - N, ROCK 55 - 60 - 70, SOLAR 60, VIGNERON 62 - 75		





**MECCANISMO + DISCO AVANZAMENTO ORIGINALE LUK RIF. 628313109**

MECANISME + DISQUE AVANCEMENT ORIGINAL LUK 628313109  
 COVER ASSEMBLY + ORIGINAL MAIN DRIVE LUK REF. 628313109  
 GETRIEBE + VORSCHLEIBE LUK 628313109  
 MECANISMO + DISCO DE AVANCE ORIGINAL LUK REF. 628313109

Art./Ref.	Note/Note	Brand	Applicazione/Application	Rif. Orig./Orig. Ref.	Immagine/Image
<b>LUK628313109</b>	Kit tutto originale LUK composto da - Kit all LUK original consists of: - Meccanismo/Clutch Ref. 128 0336 10 - Disco Avanzamento/Clutch Disc 328 0275 11	<b>SAME</b>	SAME 65, SAME DORADO 55 - 56, SAME DORADO 56 CLASSIC, SAME DORADO 60 - 65 - 66, SAME DORADO 66 CLASSIC, SAME DORADO F55 - F70, SAME DORADO S70 - V70, SAME EXPLORER 55 - 60, SAME EXPLORER 60 SPECIAL, SAME EXPLORER 65 - 65C, SAME EXPLORER 65 SPECIAL, SAME EXPLORER 70, SAME EXPLORER II 60, SAME EXPLORER II 60 SPECIAL, SAME EXPLORER II 70, SAME EXPLORER II 70 SPECIAL, SAME GOLDEN 60 COMPATTO, SAME GOLDEN 60 V, SAME GOLDEN 65 COMPATTO, SAME ROLLER 55W - 70W	0.015.9286.3, 0.015.9287.3, 0.270.2330.3/10	 



**MECCANISMO + DISCO AVANZAMENTO ORIGINALE LUK RIF. 631308219 - 631308209**

MECANISME + DISQUE AVANCEMENT ORIGINAL LUK 631308219 - 631308209  
 COVER ASSEMBLY + ORIGINAL MAIN DRIVE LUK REF. 631308219 - 631308209  
 GETRIEBE + VORSCHLEIBE LUK 631308219 - 631308209  
 MECANISMO + DISCO DE AVANCE ORIGINAL LUK REF. 631308219 - 631308209

Art./Ref.	Note/Note	Brand	Applicazione/Application	Rif. Orig./Orig. Ref.	Immagine/Image
<b>LUK631308219</b>	Kit tutto originale LUK composto da - Kit all LUK original consists of: - Meccanismo/Clutch Ref. 131 0228 10 - Disco Avanzamento a 6 pale/Clutch Disc 6 pairs of pads 331 0179 11	<b>SAME</b>	SAME DORADO 55 - 56 - 65 - 66, SAME DORADO 70 - 75 - 76, SAME DORADO 76 CLASSIC, SAME DORADO 85 - 86, SAME DORADO 86 CLASSIC, SAME DORADO F100 - F55 - F70, SAME DORADO F75 - F90, SAME DORADO S100 - S70 - S75, SAME DORADO S90, SAME DORADO V100 - V70 - V75, SAME DORADO V90, SAME EXPLORER 70 SPECIAL, SAME EXPLORER 75, SAME EXPLORER 75 CLASSIC, SAME EXPLORER 75 SPECIAL, SAME EXPLORER 75 T - 75 TB, SAME EXPLORER 80, SAME EXPLORER 90 C TURBO, SAME EXPLORER 90 TURBO, SAME EXPLORER II 70, SAME EXPLORER II 70 SPECIAL, SAME EXPLORER II 70 SPECIAL BA, SAME EXPLORER II 75 SPECIAL, SAME EXPLORER II 80 - II 80 LP, SAME EXPLORER II 80 SPECIAL BA, SAME EXPLORER II 80 SPECIAL LP, SAME EXPLORER II 90 T, SAME GOLDEN 60 COMPATTO, SAME GOLDEN 60 V, SAME GOLDEN 65 COMPATTO, SAME GOLDEN 75 COMPATTO, SAME GOLDEN 75 V, SAME GOLDEN 85 COMPATTO, SAME KRYPTON 80 - 90, SAME KRYPTON F100 M-N, SAME KRYPTON F78 C-M-N, SAME KRYPTON F80 C-N, SAME KRYPTON F88 C-M-N, SAME KRYPTON F90 C-M-N, SAME KRYPTON F98 C-M-N	0.015.9285.3, 0.015.9289.3	 
<b>LUK631308209</b>	Kit tutto originale LUK composto da - Kit all LUK original consists of: - Meccanismo/Clutch Ref. 131 0228 10 - Disco Avanzamento/Clutch Disc 331 0179 10	<b>SAME</b>	SAME DORADO 55 - 56 - 65 - 66, SAME DORADO 70 - 75 - 76, SAME DORADO 76 CLASSIC, SAME DORADO 85 - 86, SAME DORADO 86 CLASSIC, SAME DORADO F100 - F55 - F70, SAME DORADO F75 - F90, SAME DORADO S100 - S70 - S75, SAME DORADO S90, SAME DORADO V100 - V70 - V75, SAME DORADO V90, SAME EXPLORER 70 SPECIAL, SAME EXPLORER 75, SAME EXPLORER 75 CLASSIC, SAME EXPLORER 75 SPECIAL, SAME EXPLORER 75 T - 75 TB, SAME EXPLORER 80, SAME EXPLORER 90 C TURBO, SAME EXPLORER 90 TURBO, SAME EXPLORER II 70, SAME EXPLORER II 70 SPECIAL, SAME EXPLORER II 70 SPECIAL BA, SAME EXPLORER II 75 SPECIAL, SAME EXPLORER II 80 - II 80 LP, SAME EXPLORER II 80 SPECIAL BA, SAME EXPLORER II 80 SPECIAL LP, SAME EXPLORER II 90 T, SAME GOLDEN 60 COMPATTO, SAME GOLDEN 60 V, SAME GOLDEN 65 COMPATTO, SAME GOLDEN 75 COMPATTO, SAME GOLDEN 75 V, SAME GOLDEN 85 COMPATTO, SAME KRYPTON 80 - 90, SAME KRYPTON F100 M-N, SAME KRYPTON F78 C-M-N, SAME KRYPTON F80 C-N, SAME KRYPTON F88 C-M-N, SAME KRYPTON F90 C-M-N, SAME KRYPTON F98 C-M-N	0.015.9285.3, 0.015.9288.3	 

**MECCANISMO + DISCO AVANZAMENTO ORIGINALE LUK RIF. 633303109**

MECANISME + DISQUE AVANCEMENT ORIGINAL LUK 633303109  
 COVER ASSEMBLY + ORIGINAL MAIN DRIVE LUK REF. 633303109  
 GETRIEBE + VORSCHLEIBE LUK 633303109  
 MECANISMO + DISCO DE AVANCE ORIGINAL LUK 633303109

Art./Ref.	Note/Note	Brand	Applicazione/Application	Rif. Orig./Orig. Ref.	Immagine/Image
<b>LUK633303109</b>	Kit tutto originale LUK composto da - Kit all LUK original consists of: - Meccanismo/Clutch Ref. 133 0259 10 - Disco Avanzamento a 5 pale/Clutch Disc 5 pairs of pads 333 0186 10	<b>SAME</b>	SAME EXPLORER 3 100 - 3 100 T, SAME EXPLORER 3 100 TB, SAME EXPLORER 75 - 85 - 95, SAME KRYPTON 100 - 105, SAME KRYPTON 90 - 95, SAME SILVER 105 - 110, SAME SILVER 85 - 95	0.012.7094.3, 0.012.7095.3/10	 





**MECCANISMO + DISCO AVANZAMENTO ORIGINALE LUK RIF. 635304509**

MECANISME + DISQUE AVANCEMENT ORIGINAL LUK 635304509

COVER ASSEMBLY + ORIGINAL MAIN DRIVE LUK REF. 635304509

GETRIEBE + VORSCHLEIBE LUK 635304509

MECANISMO + DISCO DE AVANCE ORIGINAL LUK 635304509

Art./Ref.	Note/Note	Brand	Applicazione/Application	Rif. Orig./Orig. Ref.	Immagine/Image
LUK635304509	Kit tutto originale LUK composto da - Kit all LUK original consists of: - Meccanismo/Clutch Ref. 135 0241 10 - Disco Avanzamento a 6 pale/Clutch Disc 6 pairs of pads 335 0186 10	SAME	SAME ANTARES 110 - 130, SAME ANTARES II 130, SAME SILVER 115 - 130	0.008.5595.3, 0.008.5596.3	
LUK500084630	Cuscinetto reggispinta 90,60 x 55 x 22 mm / Thrust Bearing 90,60 x 55 x 22 mm		SAME ANTARES 100, SAME ANTARES 110 - 130, SAME ANTARES II 110, SAME ANTARES II 130, SAME EXPLORER 100 SPECIAL LP, SAME EXPLORER 80 SPECIAL, SAME EXPLORER 80 SPECIAL LP, SAME EXPLORER 90 SPECIAL, SAME EXPLORER 90 SPECIAL LP, SAME EXPLORER II 80, SAME EXPLORER II 80 LP, SAME EXPLORER II 80 TOP, SAME EXPLORER II 90 T, SAME GALAXY 170, SAME LASER 170, SAME ROW CROP 90, SAME SILVER 100.4, SAME SILVER 100.6, SAME SILVER 115 - 130, SAME SILVER 80, SAME SILVER 90	2.2999.207.0, 2.2999.510.0	



**MECCANISMO + DISCO AVANZAMENTO ORIGINALE LUK RIF. 635351009**

MECANISME + DISQUE AVANCEMENT ORIGINAL LUK 635351009

COVER ASSEMBLY + ORIGINAL MAIN DRIVE LUK REF. 635351009

GETRIEBE + VORSCHLEIBE LUK 635351009

MECANISMO + DISCO DE AVANCE ORIGINAL LUK 635351009

Art./Ref.	Note/Note	Brand	Applicazione/Application	Rif. Orig./Orig. Ref.	Immagine/Image
LUK635351009	Kit tutto originale LUK composto da - Kit all LUK original consists of: - Meccanismo/Clutch Ref. 135 0279 10 - Disco Avanzamento a 7 pale/Clutch Disc 7 pairs of pads 335 0321 10	SAME	SAME 170, SAME GALAXY 170, SAME HERCULES 160, SAME JAGUAR 100 EXPORT, SAME JAGUAR 95 EXPORT, SAME LASER 100 - 110 - 130, SAME LASER 150 - 165 - 170, SAME LASER 85 TRANSPORTER, SAME LASER 90, SAME LEOPARD 90 T, SAME TAURUS 100 E, SAME TRIDENT 130	0.014.0175.4, 0.014.0176.3	
LUK500059730	Cuscinetto reggispinta completo 111 x 65 x 30 mm / Bearing + carrier assy 111 x 65 x 30 mm		BUFFALO 120, BUFFALO 130, LASER 110, LASER 130, LASER 150, LASER 165	0.250.6533.3, 0.264.6533.3/20	
LUK500084630	Cuscinetto reggispinta 90,60 x 55 x 22 mm / Thrust Bearing 90,60 x 55 x 22 mm		SAME ANTARES 100, SAME ANTARES 110 - 130, SAME ANTARES II 110, SAME ANTARES II 130, SAME EXPLORER 100 SPECIAL LP, SAME EXPLORER 80 SPECIAL, SAME EXPLORER 80 SPECIAL LP, SAME EXPLORER 90 SPECIAL, SAME EXPLORER 90 SPECIAL LP, SAME EXPLORER II 80, SAME EXPLORER II 80 LP, SAME EXPLORER II 80 TOP, SAME EXPLORER II 90 T, SAME GALAXY 170, SAME LASER 170, SAME ROW CROP 90, SAME SILVER 100.4, SAME SILVER 100.6, SAME SILVER 115 - 130, SAME SILVER 80, SAME SILVER 90	2.2999.207.0, 2.2999.510.0	

**KIT FRIZIONE LUK 625300710**

KIT EMBRAYAGE LUK 625300710

KIT CLUTCH LUK 625300710

KIT KUPPLUNG LUK 625300710

KIT EMBRAGUE LUK 625300710

Art./Ref.	Note/Note	Brand	Applicazione/Application	Rif. Orig./Orig. Ref.	Immagine/Image
<b>LUK625300710</b>	Kit tutto originale LUK composto da - Kit all LUK original consists of: - Meccanismo/Clutch Ref. 225 0055 10 - Disco Pto/Disc Pto 323 0556 10 - Cuscinetto/Bearing Ref. 500 0459 00 - Cuscinetto/Bearing Ref. 500 0673 00 - Cuscinetto/Bearing Ref. 410 0026 00	<b>SAME</b>	SAME ARGON 55 CLASSIC, SAME ARGON F 55 CLASSIC	0.008.4743.4, 0.008.4744.3, 0.011.9063.3, 0.012.2564.4, 2.202.018.0, 2.2999.153.0/10, 2.2999.478.0	
<b>LUK500045900</b>	Cuscinetto reggispinta 90 x 50 x 21,60 mm / Thrust Bearing 90 x 50 x 21,60 mm		ARGON 50/55/55F/60/70/75F/70CL, ASTER 60/70,FRUTTETO 60/75, FRUTTETO 60II/75II/85II, KRYPTON V70/V80, ROCK 55/60/70	2.299.153.0/1, 2.2999.153.0, 2.2999.153.0/1, 2.2999.153.0/10, 2.2999.478.0	
<b>LUK500067300</b>	Cuscinetto pto 100 x 65 x 18 mm / Pto Bearing 100 x 65 x 18 mm		SAME ARGON 55 CLASSIC, SAME ARGON F 55 CLASSIC	2.2021.017.0	
<b>LUK410002600</b>	Cuscinetto volano 47 x 20 x 14 mm - Bearing 47 x 20 x 14 mm		ASTER 60 - 70, FRUTTETO 60 - 75, FRUTTETO II 100, FRUTTETO II 55, FRUTTETO II 60, FRUTTETO II 70, FRUTTETO II 75, FRUTTETO II 85, FRUTTETO II 90, KRYPTON V 70 C - N, KRYPTON V 80 L - M - N, ROCK 55 - 60 - 70, SAME ARGON 55 CLASSIC, SAME ARGON F 55 CLASSIC, SOLAR 60, VIGNERON 62 - 75		

**KIT FRIZIONE LUK 631107510**

KIT EMBRAYAGE LUK 631107510

KIT CLUTCH LUK 631107510

KIT KUPPLUNG LUK 631107510

KIT EMBRAGUE LUK 631107510

Art./Ref.	Note/Note	Brand	Applicazione/Application	Rif. Orig./Orig. Ref.	Immagine/Image
<b>LUK631107510</b>	Kit tutto originale LUK composto da - Kit all LUK original consists of: - Meccanismo/Clutch Ref. 131 0229 10 - Disco avanzamento/Disc clutch 331 0184 10 - Cuscinetto/Bearing Ref. 500 0076 11	<b>SAME</b>	SAME ANTARES 100, SAME DORADO 60 - 70, SAME EXPLORER 70 C ERGOMATIC, SAME EXPLORER 70 SPECIAL, SAME EXPLORER 90 C TURBO, SAME EXPLORER II 60 SPECIAL, SAME EXPLORER II 70 SPECIAL, SAME EXPLORER II 70 SPECIAL BA, SAME EXPLORER II 70 TOP, SAME EXPLORER II 80 SPECIAL BA, SAME EXPLORER II 80 TOP, SAME EXPLORER II 90 T, SAME GOLDEN 60 - 65 COMPATTO, SAME GOLDEN 75 - 85 COMPATTO, SAME ROW CROP 90	0.014.9424.3, 0.014.9433.3, 2.2999.475.0	

**MECCANISMO + DISCO AVANZAMENTO ORIGINALE LUK RIF. 633312310 - 633312300**

MECANISME + DISQUE AVANCEMENT ORIGINAL LUK 633312310 - 633312300

COVER ASSEMBLY + ORIGINAL MAIN DRIVE LUK REF. 633312310 - 633312300

GETRIEBE + VORSCHLEIBE LUK 633312310 - 633312300

MECANISMO + DISCO DE AVANCE ORIGINAL LUK REF. 633312310 - 633312300

Art./Ref.	Note/Note	Brand	Applicazione/Application	Rif. Orig./Orig. Ref.	Immagine/Image
LUK633312310	<p>Kit tutto originale LUK composto da - Kit all LUK original consists of:</p> <ul style="list-style-type: none"> <li>- Meccanismo/Clutch Ref. 133 0279 10</li> <li>- Disco avanzamento a 6 pale/Disc clutch 6 pairs of pads 333 0116 10</li> <li>- Cuscinetto/Bearing Ref. 500 0846 30</li> </ul>		<p>SAME ANTARES 100, SAME EXPLORER 100 SPECIAL LP, SAME EXPLORER 80 SPECIAL, SAME EXPLORER 80 SPECIAL LP, SAME EXPLORER 90 SPECIAL, SAME EXPLORER 90 SPECIAL LP, SAME EXPLORER II 80, SAME EXPLORER II 80 LP, SAME EXPLORER II 80 SPECIAL LP, SAME EXPLORER II 80 TOP, SAME EXPLORER II 90 T, SAME ROW CROP 90, SAME SILVER 100.4 - 100.6, SAME SILVER 80 - 90</p>	<p>0.008.4184.3, 0.014.9423.3/10, 0.016.6105.3, 2.2999.207.0, 2.2999.510.0</p>	
LUK633312300	<p>Kit tutto originale LUK composto da - Kit all LUK original consists of:</p> <ul style="list-style-type: none"> <li>- Meccanismo/Clutch Ref. 133 0279 10</li> <li>- Disco avanzamento/Disc clutch 333 0117 10</li> <li>- Cuscinetto/Bearing Ref. 500 0846 30</li> </ul>	SAME	<p>SAME ANTARES 100, SAME EXPLORER 100 SPECIAL LP, SAME EXPLORER 80 SPECIAL, SAME EXPLORER 80 SPECIAL LP, SAME EXPLORER 90 SPECIAL, SAME EXPLORER 90 SPECIAL LP, SAME EXPLORER II 80, SAME EXPLORER II 80 LP, SAME EXPLORER II 80 SPECIAL LP, SAME EXPLORER II 80 TOP, SAME EXPLORER II 90 T, SAME ROW CROP 90, SAME SILVER 100.4 - 100.6, SAME SILVER 80 - 90</p>	<p>0.008.4184.3, 0.014.9423.3/10, 0.014.9431.3, 2.2999.207.0, 2.2999.510.0</p>	
LUK500084630	<p>Cuscinetto reggispinta 90,60 x 55 x 22 mm / Thrust Bearing 90,60 x 55 x 22 mm</p>		<p>SAME ANTARES 100, SAME ANTARES 110 - 130, SAME ANTARES II 110, SAME ANTARES II 130, SAME EXPLORER 100 SPECIAL LP, SAME EXPLORER 80 SPECIAL, SAME EXPLORER 80 SPECIAL LP, SAME EXPLORER 90 SPECIAL, SAME EXPLORER 90 SPECIAL LP, SAME EXPLORER II 80, SAME EXPLORER II 80 LP, SAME EXPLORER II 80 TOP, SAME EXPLORER II 90 T, SAME GALAXY 170, SAME LASER 170, SAME ROW CROP 90, SAME SILVER 100.4, SAME SILVER 100.6, SAME SILVER 115 - 130, SAME SILVER 80, SAME SILVER 90</p>	<p>2.2999.207.0, 2.2999.510.0</p>	







**MECCANISMO + DISCO AVANZAMENTO ORIGINALE LUK RIF. 633353510 - 635353810**

MECANISME + DISQUE AVANCEMENT ORIGINAL LUK 635353510 - 635353810

COVER ASSEMBLY + ORIGINAL MAIN DRIVE LUK REF. 635353510 - 635353810

GETRIEBE + VORSCHLEIBE LUK 635353510 - 635353810

MECANISMO + DISCO DE AVANCE ORIGINAL LUK REF. 635353510- 635353810

Art./Ref.	Note/Note	Brand	Applicazione/Application	Rif. Orig./Orig. Ref.	Immagine/Image
<b>LUK635353510</b>	Kit tutto originale LUK composto da - Kit all LUK original consists of: - Meccanismo/Clutch Ref. 135 0284 10 - Disco avanzamento 330 mm Z24/Disc clutch 330 mm Z24 333 0215 10 - Cuscinetto/Bearing Ref. 500 0076 11	SAME	SAME EXPLORER 80 SPECIAL, SAME EXPLORER 80 SPECIAL LP, SAME EXPLORER 90 SPECIAL, SAME EXPLORER 90 SPECIAL LP, SAME EXPLORER II 80, SAME EXPLORER II 80 LP, SAME EXPLORER II 90 T, SAME ROW CROP 100.6, SAME SILVER 100.4- 100.6, SAME SILVER 80 - 90	0.015.6381.3, 0.015.6386.3, 2.2999.475.0	  
<b>LUK635353810</b>	Kit tutto originale LUK composto da - Kit all LUK original consists of: - Meccanismo/Clutch Ref. 135 0284 10 - Disco avanzamento 350 mm Z24/Disc clutch 350 mm Z24 335 0337 10 - Cuscinetto/Bearing Ref. 500 0076 11		SAME EXPLORER 80 SPECIAL, SAME EXPLORER 80 SPECIAL LP, SAME EXPLORER 90 SPECIAL, SAME EXPLORER 90 SPECIAL LP, SAME EXPLORER II 80, SAME EXPLORER II 80 LP, SAME EXPLORER II 90 T, SAME ROW CROP 100.6, SAME SILVER 100.4- 100.6, SAME SILVER 80 - 90	0.015.6328.3, 0.015.6386.3, 2.2999.475.0	  



**MECCANISMO + DISCO AVANZAMENTO ORIGINALE LUK RIF. 635353910**

MECANISME + DISQUE AVANCEMENT ORIGINAL LUK 635353910

COVER ASSEMBLY + ORIGINAL MAIN DRIVE LUK REF. 635353910

GETRIEBE + VORSCHLEIBE LUK 635353910

MECANISMO + DISCO DE AVANCE ORIGINAL LUK REF. 635353910

Art./Ref.	Note/Note	Brand	Applicazione/Application	Rif. Orig./Orig. Ref.	Immagine/Image
<b>LUK635353910</b>	Kit tutto originale LUK composto da - Kit all LUK original consists of: - Meccanismo/Clutch Ref. 135 0284 10 - Disco avanzamento 350 mm Z21/Disc clutch 350 mm Z21 335 0338 10 - Cuscinetto/Bearing Ref. 500 0076 11	SAME	SAME ANTARES II 110, SAME SILVER 110	0.007.7930.3/10, 0.015.6386.3, 2.2999.475.0	  



**KIT FRIZIONE LUK ORIGINALE RIF. MECCANISMO 0.014.9017.3**

KIT EMBRAYAGE LUK ORIGINAL REF. 0.014.9017.3

KIT CLUTCH ORIGINAL LUK REF. 0.014.9017.3

KIT KUPPLUNG LUK REF. 0.014.9017.3

KIT EMBRAGUE LUK ORIGINAL REF. 0.014.9017.3

Art./Ref.	Note/Note	Brand	Applicazione/Application	Rif. Orig./Orig. Ref.	Immagine/Image
LUK131031210	Meccanismo Frizione 12" - Luk originale	SAME	SAME DORADO 3 70 - 80 - 90, SAME DORADO F 100 - F 70, SAME DORADO F 75 - F 90, SAME EXPLORER 3 85 - 85 T, SAME EXPLORER 3 85 TB, SAME FRUTTETO 3 100 - 3 100 S, SAME FRUTTETO 3 100 V, SAME FRUTTETO 3 110 - 3 110 S, SAME FRUTTETO 3 110 V, SAME FRUTTETO 3 80 - 3 80 S, SAME FRUTTETO 3 80 V, SAME FRUTTETO 3 90 - 3 90 S, SAME FRUTTETO 3 90 V, SAME FRUTTETO 3 90.3 S, SAME FRUTTETO 3 90.3 V	0.014.9017.3	
LUK331034610	Disco avanzamento 310 mm a 6 pale Luk originale - Clutch Disc Diameter 310 mm 6 pairs of pads Original Luk		SAME DORADO 3 70 - 80 - 90, SAME DORADO F 100 - F 70, SAME DORADO F 75 - F 90, SAME EXPLORER 3 85 - 85 T, SAME EXPLORER 3 85 TB, SAME FRUTTETO 3 100 - 3 100 S, SAME FRUTTETO 3 100 V, SAME FRUTTETO 3 110 - 3 110 S, SAME FRUTTETO 3 110 V, SAME FRUTTETO 3 80 - 3 80 S, SAME FRUTTETO 3 80 V, SAME FRUTTETO 3 90 - 3 90 S, SAME FRUTTETO 3 90 V, SAME FRUTTETO 3 90.3 S, SAME FRUTTETO 3 90.3 V	0.014.9016.3	



**KIT FRIZIONE LUK ORIGINALE RIF. MECCANISMO 0.016.6106.3**

KIT EMBRAYAGE LUK ORIGINAL REF. 0.016.6106.3

KIT CLUTCH ORIGINAL LUK REF. 0.016.6106.3

KIT KUPPLUNG LUK REF. 0.016.6106.3

KIT EMBRAGUE LUK ORIGINAL REF. 0.016.6106.3

Art./Ref.	Note/Note	Brand	Applicazione/Application	Rif. Orig./Orig. Ref.	Immagine/Image
LUK135028510	Meccanismo Frizione 14" - Luk originale	SAME	SAME ANTARES II 110, SAME EXPLORER 75, SAME EXPLORER 80 SPECIAL, SAME EXPLORER 80 SPECIAL LP, SAME EXPLORER 85 - 85 T, SAME EXPLORER 85 TB, SAME EXPLORER 90 SPECIAL, SAME EXPLORER 90 SPECIAL LP, SAME EXPLORER 95, SAME EXPLORER 95 CLASSIC, SAME EXPLORER 95 T, SAME EXPLORER 95 TB, SAME EXPLORER II 85 SPECIAL, SAME EXPLORER II 90 T, SAME EXPLORER II 95 SPECIAL, SAME ROW CROP 100, SAME ROW CROP 100.6, SAME ROW CROP 90, SAME SILVER 100.4 - 100.6, SAME SILVER 105 - 110, SAME SILVER 80 - 85 - 90 - 95	0.016.6106.3	
LUK333011610	Disco avanzamento 330 mm a 6 pale Luk originale - Clutch Disc Diameter 330 mm 6 pairs of pads Original Luk		SAME ANTARES II 110, SAME EXPLORER 75, SAME EXPLORER 80 SPECIAL, SAME EXPLORER 80 SPECIAL LP, SAME EXPLORER 85 - 85 T, SAME EXPLORER 85 TB, SAME EXPLORER 90 SPECIAL, SAME EXPLORER 90 SPECIAL LP, SAME EXPLORER 95, SAME EXPLORER 95 CLASSIC, SAME EXPLORER 95 T, SAME EXPLORER 95 TB, SAME EXPLORER II 85 SPECIAL, SAME EXPLORER II 90 T, SAME EXPLORER II 95 SPECIAL, SAME ROW CROP 100, SAME ROW CROP 100.6, SAME ROW CROP 90, SAME SILVER 100.4 - 100.6, SAME SILVER 105 - 110, SAME SILVER 80 - 85 - 90 - 95	0.016.6105.3	

**MECCANISMO + DISCO PTO ORIGINALE LUK RIF. 628313009**

MECANISME + DISQUE PTO ORIGINAL LUK 628313009

COVER ASSEMBLY + ORIGINAL PTO DISC LUK REF.628313009

GETRIEBE + ZAPFWELLENSCHEIBE LUK 628313009

MECANISMO + DISCO PTO ORIGINAL LUK REF. 628313009

Art./Ref.	Note/Note	Brand	Applicazione/Application	Rif. Orig./Orig. Ref.	Immagine/Image
<b>LUK628313009</b>	Kit tutto originale LUK composto da - Kit all LUK original consists of: - Meccanismo/Clutch Ref. 228 0067 11 - Disco Pto/Disc Pto 328 0127 16	<b>SAME LAMBORGHINI HURLIMANN</b>	LAMBORGHINI R613V, SAME CORSARO 70 FRUTTETO, SAME CORSARO 70 SYNCHRO, SAME FALCON 50, SAME MINITAURO 60 FRUTTETO, SAME MINITAURUS 60 FRUTTETO, SAME MINITAURUS 60 SYNCHRO, SAME TAURUS 60, SAME VIGNERON 60 - 70	0.194.2210.4/20, 0.194.2213.3/10	
<b>LUK500058810</b>	Cuscinetto reggispinta 102 x 65 x 26 mm / Thrust Bearing 102 x 65 x 26 mm	<b>SAME LAMBORGHINI HURLIMANN</b>	LAMBORGHINI R613V, SAME CORSARO 70 FRUTTETO, SAME CORSARO 70 SYNCHRO, SAME FALCON 50, SAME MINITAURO 60 FRUTTETO, SAME MINITAURUS 60 FRUTTETO, SAME MINITAURUS 60 SYNCHRO, SAME TAURUS 60, SAME VIGNERON 60 - 70	2.2999.003.0	

# 1.7.15 Frizioni sterzo

Steering Clutches



**ama**

**Ricambi & accessori per macchine agricole**  
SPARE PARTS & ACCESSORIES FOR AGRICULTURAL MACHINE

Tutti gli articoli della presente sezione, prodotti da AMA SPA e/o da terzi per conto di AMA, sono adattabili ("non originali") alle marche indicate ai sensi di quanto previsto dal REG. CE n. 1400/2002. I diritti sui marchi citati appartengono ai legittimi proprietari e il loro uso ha l'esclusiva finalità di consentire all'utilizzatore la comparazione dei diversi prodotti.  
All items of this section, manufactured by AMA SPA and/or any third party on behalf of AMA, are adaptable ("non-original") to the brands listed under the provisions of the REG. CE n. 1400/2002. The rights on the trademarks belong to their respective owners and their usage is only aimed to allow the user to compare different products.

**TAMBURI FRIZIONI STERZO ADATTABILI**

BARILLER EMBRAYAGE DE DIRECTION ADAPTABLE

DRUM STEERING CLUTCHES ADAPTABLE

KUPPLUNGSTROMMEL PASSEND ZU

TAMBOR DE LA FRICCION DE DIRECCION ADAPTABLE

Art./Ref.	Brand	Applicazione/Application	Rif. Orig./Orig. Ref.	Immagine/Image
10543	FIAT	55.46, 55.46 DT, 60.46, 60.46 DT, 640, 65.46, 65.46 DT	4980824	
14355		355C, 411C, 455C, 505C, 555C, 605C	4992428, 566522	
14773		450, 480S, 500S, 540S	596206	
14779		665C, 765C	5119536	
14779	NEW HOLLAND	TK 60.65, TK 60.65M, TK 60.65V, TK 60.75, TK 60.75M, TK 70.65, TK 70.65M, TK 70.75, TK 70.75M, TK 80.65, TK 80.75	5119536	
14335		TK 55-65F, TK 55-65M, TK 55-65V, TK 55-75F, TK 55-75M, TK 55-75V, TK 55-85F, TK 55-85M, TK 55-85V, TK 60-65, TK 60-65M, TK 60-65V, TK 60-75V, TK 60-85F, TK 60-85V, TK65F, TK65V, TK70FA, TK70VA, TK75F, TK75FA, TK75V, TK75VA	5119531, 5148334	



**MANICOTTI FRIZIONE COMPLETI**

MANCHON D'EMBRAYAGE  
 COMPLETE CLUTCHE SLEEVES  
 KUPPLUNGSHULSE  
 MANGUITO D'EMBRAGUE

Art./Ref.	Brand	Note/Note	Applicazione/Application	Rif. Orig./Orig. Ref.	Immagine/Image
05764	FIAT	Con foro ingrassatore/With greasing hole	355C, 411C, 455C, 505C, 605C	4974241, 574317, 599733	
35408			355C SUPER, 455C SUPER, 505C SUPER, 555C SUPER, 605C SUPER	4984282	

**ANELLI DENTATI STERZO ADATTABILI**

BAGUES DE DIRECTION CRANTEE ADAPTABLE  
 STEERING TOOTHED RINGS ADAPTABLE  
 LENNKUPPLUNGEN PASSEND ZU  
 EMBRAGUES DE DIRECCION ADAPTABLE

Art./Ref.	Brand	Applicazione/Application	Rif. Orig./Orig. Ref.	Note/Notes	Immagine/Image
10579	FIAT	25C, 311C	5163644, 568911	219,2 X 152 X 4,7	
10577		655C, 805C, FL6, OM 50	5104903, 5161597, 5170228, 568400	271 X 201 X 5	
10577	LANDINI	C7800, C7830, C8860	3300186M1	271 X 201 X 5	



**DISCHI FRIZIONE STERZO ADATTABILI**

DISQUE EMBRAYAGE DE DIRECTION ADAPTABLE

DISC OF STEERING CLUTCHES ADAPTABLE

KUPPLUNGSSCHEIBE PASSEND ZU

DISCO FRICCIÓN DE DIRECCIÓN ADAPTABLE

Art./Ref.	Brand	Applicazione/Application	Rif. Orig./Orig. Ref.	Note/Notes	Immagine/Image
10573	FIAT	312C, 355C, 455C, 465C, 505C, 605C, 665C, 765C, FL4	4981417, 4981418, 5104806, 5104894, 5109934, 5109935, 5109936, 5109937, 5109938, 5174442, 566520	Impasto normale colore rosso - Normal compound red colour 239x180x4,8	
37815	LANDINI	C4500, C4830, C5500, C5830, C6500, C6830, CF4830, CF5030, CF5830, CF6030, CF6060, CF6830, TREKKER: CF55, TREKKER: CF60, TREKKER: CF70	1423483M1	Impasto rinforzato ad alta resistenza - Strength compound with high resistance 239x180x4,8	
37815	NEW HOLLAND	SERIE 55.65 - 60.65 - 80.65, TK65F, TK65V, TK70FA, TK70VA, TK75F, TK75FA, TK75V, TK75VA	5197641	Impasto rinforzato ad alta resistenza - Strength compound with high resistance 239x180x4,8	

# 1.7.16 Frizioni per piccoli motori

Small Engine Clutches



**ama**

**Ricambi & accessori per macchine agricole**

SPARE PARTS & ACCESSORIES FOR AGRICULTURAL MACHINE

Tutti gli articoli della presente sezione, prodotti da AMA SPA e/o da terzi per conto di AMA, sono adattabili ("non originali") alle marche indicate ai sensi di quanto previsto dal REG. CE n. 1400/2002. I diritti sui marchi citati appartengono ai legittimi proprietari e il loro uso ha l'esclusiva finalità di consentire all'utilizzatore la comparazione dei diversi prodotti. All items of this section, manufactured by AMA SPA and/or any third party on behalf of AMA, are adaptable ("non-original") to the brands listed under the provisions of the REG. CE n. 1400/2002. The rights on the trademarks belong to their respective owners and their usage is only aimed to allow the user to compare different products.

**FRIZIONI PICCOLI MOTORI ADATTABILI**

EMBRAYAGES PETIT MOTEURS ADAPTABLE

SMALL ENGINE CLUTCHES ADAPTABLE

KUPPLUNGEN KLEINE MOTOREN PASSEND ZU

EMBRAGUES MOTORES PEQUENOS ADAPTABLE



Art./Ref.	Dimensioni/Sizes	Note/Note	Brand	Applicazione/Application	Rif. Orig./Orig. Ref.
05664	Ø 138 x 25 mm	Frizione monodisco con molle a diaframma //Single disc clutch with diaphragm spring	<b>BARBIERI</b>	MOTOZAPPA ZEBRA FB 210	
05660	Ø 104 x 97 mm	Frizione conica. Albero 22,5 mm, Conicita' 1:5, 8 cave/Tapered clutch, Shaft 22.5 mm, Taper 1:5 12x15EV, 8 splines	<b>BCS</b>	MOTOCOLTIVATORI SERIE 600/700, MOTOCOLTIVATORI SERIE 715/735, MOTOFALCIATRICI SERIE 600/700, MOTOFALCIATRICI SERIE 715/735	592.48106
05660	Ø 104 x 97 mm	Frizione conica. Albero 22,5 mm, Conicita' 1:5, 8 cave/Tapered clutch, Shaft 22.5 mm, Taper 1:5 12x15EV, 8 splines	<b>BENASSI</b>	MOTOZAPPA RL 300 (FRIZ. LUNGA)	
05662	Ø 104 x 66 mm	Frizione conica, Albero 22,5 mm, Conicita' 1:5, 8 cave/Tapered clutch, shaft 22.5 mm, Taper 1:5 12x15EV, 8 splines		MOTOZAPPA RL300 (FRIZ. CORTA)	
05660	Ø 104 x 97 mm	Frizione conica. Albero 22,5 mm, Conicita' 1:5, 8 cave/Tapered clutch, Shaft 22.5 mm, Taper 1:5 12x15EV, 8 splines	<b>BERTOLINI</b>	MOTOCOLT 307 (FRIZ. LUNGA)	
05664	Ø 138 x 25 mm	Frizione monodisco con molle a diaframma /Single disc clutch with diaphragm spring		MOTOCOLT 305	81.9220.00
09512	Ø 104 x 84,5 mm	Frizione conica, Albero 22,5 mm, Conicita' 1:5, 8 cave/Tapered clutch, Shaft 22.5 mm, Taper 1:5 12x15EV, 8 splines		MOTOCOLT 307-406 (FRIZ. CORTA), MOTOFALCIATRICE 134 - 140	120003
09514	Ø 104 x 87,5 mm	Frizione conica vite lunga, Albero 22,5 mm, Conicita' 1:5, 8 cave/Tapered clutch long screw, Shaft 22.5 mm, Taper 1:5 12x15EV, 8 splines		MOTOCOLT 406 (MOT ALN330)	
05664	Ø 138 x 25 mm	Frizione monodisco con molle a diaframma/Single disc clutch with diaphragm spring	<b>BRUMITAL</b>	MOTOZAPPA	
05664	Ø 138 x 25 mm	Frizione monodisco con molle a diaframma/Single disc clutch with diaphragm spring	<b>CARRARO</b>	CARRARINO SERIE MINI E SPECIAL	5.107.502
05664	Ø 138 x 25 mm	Frizione monodisco con molle a diaframma/Single disc clutch with diaphragm spring	<b>EUROGARDEN</b>	MOTOCOLTIVATORI TITANO	
05660	Ø 104 x 97 mm	Frizione conica. Albero 22,5 mm, Conicita' 1:5, 8 cave/ Frizione conica. Albero 22,5 mm, Conicita' 1:5, 8 cave/Tapered clutch. Shaft 22.5 mm, Taper 1:5 12x15EV, 8 splines/ Frizione conica. Albero 22,5 mm, Conicita' 1:5, 8 cave/ Frizione conica. Albero 22,5 mm, Conicita' 1:5, 8 cave	<b>EUROSYSTEMS</b>	MOTOZAPPA (BENZINA)	
05660	Ø 104 x 97 mm	Frizione conica. Albero 22,5 mm, Conicita' 1:5, 8 cave/Tapered clutch, Shaft 22.5 mm, Taper 1:5 12x15EV, 8 splines	<b>FERRARI</b>	MOTOCOLT 71 (2A SERIE)	
05664	Ø 138 x 25 mm	Frizione monodisco con molle a diaframma/Single disc clutch with diaphragm spring		MOTOCOLT 71 (1A SERIE)	81.9220.00
09545	Ø 215	Frizione monodisco a molle elicoidali/Single plate clutch with coil springs		TRATTORINI MT65 (2	7.15.208
09533	Piatto Ø 187 mm	Frizione monodisco a molle elicoidali/Single plate clutch with coil springs	<b>FIAT</b>	18 LA PICCOLA, 200, 211R, 213R, 215R, 215R (FINO A TELAIO 313566), 220C, 241R, 251D	4023341
09545	Ø 215	Frizione monodisco a molle elicoidali/Single plate clutch with coil springs		215R (DAL TELAIO 313667), 25 CI - CP - CSI (TIPO A PED), 25 R, 25 RS, 250, 255 C, 300, 311, 312, 315 N, 331 R	558106, 595731

Art./Ref.	Dimensioni/Sizes	Note/Note	Brand	Applicazione/Application	Rif. Orig./Orig. Ref.
05662	Ø 104 x 66 mm	Frizione conica, Albero 22,5 mm, Conicita' 1:5, 8 cave/ Tapered clutch, shaft 22.5 mm, Taper 1:5 12x15EV, 8 splines	FORT	MOTOZAPPA TIGROTTO-EL TIGRE	
05664	Ø 138 x 25 mm	Frizione monodisco con molle a diaframma/ Single disc clutch with diaphragm spring		MOTOZAPPA-MOTOFALCIA- TRICE	
05660	Ø 104 x 97 mm	Frizione conica, Albero 22,5 mm, Conicita' 1:5, 8 cave/ Tapered clutch, Shaft 22.5 mm, Taper 1:5 12x15EV, 8 splines	GRILLO	MOTOCOLTIVATORI GRILLINO 1100, MOTOCOLTIVATORI GRILLINO 127, MOTOFALCIA- TRICI BL / BC	
05664	Ø 138 x 25 mm	Frizione monodisco con molle a diaframma/ Single disc clutch with diaphragm spring	IMER	MOTOZAPPA SERIE 115	
05660	Ø 104 x 97 mm	Frizione conica, Albero 22,5 mm, Conicita' 1:5, 8 cave/ Tapered clutch, Shaft 22.5 mm, Taper 1:5 12x15EV, 8 splines	MAB	MOTOCOLTIVATORI PANDA 135 10HP	592431394
09533	Piatto Ø 187 mm	Frizione monodisco a molle elicoidali/Single plate clutch with coil springs	NIBBI	TRATTORINO G119-219- 520-521	
05664	Ø 138 x 25 mm	Frizione monodisco con molle a diaframma/ Single disc clutch with diaphragm spring	NIBBI DECIMO	MOTOCOLTIVATORI MAJOR	
05662	Ø 104 x 66 mm	Frizione conica, Albero 22,5 mm, Conicita' 1:5, 8 cave/ Tapered clutch, shaft 22.5 mm, Taper 1:5 12x15EV, 8 splines	PASQUALI	MOTOZAPPA 938-939- 952-953	939 183 0
09545	Ø 215	Frizione monodisco a molle elicoidali/Single plate clutch with coil springs	RAPID	MOTOFALCIATRICE ALLTRAC	
05664	Ø 138 x 25 mm	Frizione monodisco con molle a diaframma Single disc clutch with diaphragm spring	VALPADANA	MOTOCOLT VMC 12-160	109081

## DISCHI PER FRIZIONI MOTORI SINO A 14HP ADATTABILI

DISQUES D'EMBRAYAGES POUR MOTEUR JUSQU'À 14HP ADAPTABLE

CLUTCH DISCS FOR ENGINE UP TO 14HP ADAPTABLE

KUPPLUNGSSCHEIBE FÜR MOTOREN BIS 14HP PASSEND ZU

DISCOS DE EMBRAGUE PARA MOTORES HASTA 14HP ADAPTABLE



Art./Ref.	Dimensioni/Sizes	Note/Note	Brand	Applicazione/Application
02364	Ø 140 x 96mm, 17x15 EV, 20 cave/splines	Disco frizione rigido in ferodo/Rigid clutch disc lining	ADRIATICA	MINIMEC SUPERMEC 14 HP
02368	181x127mm, 23x20 EV, 20 cave/splines	Disco frizione rigido in ferodo/Rigid clutch disc lining		MASTERMEC L2 - R2 - S2 - L30, MOTOAGRICOLA MAJORMEC 1, MOTOAGRICOLA MAJORMEC 2
02365	160x110mm, 19x15,5x3, 10 cave/splines	Disco frizione rigido in ferodo/Rigid clutch disc lining	BARBIERI	MOTOCOLTIVATORI FB SERIE 1400, MOTOCOLTIVATORI LEOPARD, MOTOCOLTIVATORI PIONEER
02366	184x127mm, 19x15,5x3, 10 cave/splines	Disco frizione rigido in ferodo/Rigid clutch disc lining		TRATTORINI FB SERIE 1800, TRATTORINI PANTHER - DELFINO
02379	110x60mm, 15x12EV, 8 cave/splines	Disco frizione rigido in ferodo/Rigid clutch disc lining		MOTOZAPPE ZEBRA FB SERIE 210
02396	94x61mm, 15x12EV, 8 cave/ splines	Disco frizione rigido in ferodo/Rigid clutch disc lining		MOTOCOLT PUMA SERIE 310 - 900, MOTOCOLTIVATORI GAZZELLA
05665	110x75mm, 15x12EV, 8 cave/splines	Disco rigido sinterizzato/Sintered hard drive		MOTOCOLT GIAGUARO SERIE 1600

Art./Ref.	Dimensioni/Sizes	Note/Note	Brand	Applicazione/Application	Rif. Orig./Orig. Ref.
<b>01539</b>	178x133mm, 25x20EV, 15 cave/splines	Disco frizione rigido in ferodo/Rigid clutch disc lining	<b>BCS</b>	MOTOFALCIATRICE 622	590024260
<b>02363</b>	155x114mm, 16x13x3,5, 6 cave/splines	Disco frizione rigido in ferodo/Rigid clutch disc lining		MOTOCOLTIVATORI 705	581010091
<b>02372</b>	178x133mm, 23x18x3, 10 cave/splines	Disco frizione rigido in ferodo/Rigid clutch disc lining	<b>BEDOGNI</b>	MOTOFALCIATRICE OLIMPIA	12231
<b>02379</b>	110x60mm, 15x12EV, 8 cave/splines	Disco frizione rigido in ferodo/Rigid clutch disc lining		MOTOCOLTIVATORE COLIBRI', MOTOFALCIATRICE	60053
<b>05665</b>	110x75mm, 15x12EV, 8 cave/splines	Disco rigido sinterizzato/Sintered hard drive		MOTOCOLTIVATORI COLIBRI'	
<b>02379</b>	110x60mm, 15x12EV, 8 cave/splines	Disco frizione rigido in ferodo/Rigid clutch disc lining	<b>BENASSI</b>	MOTOCOLTIVATORI 421, MOTOZAPPA RL 95 - 100 - 634L	
<b>02364</b>	Ø 140 x 96mm, 17x15 EV, 20 cave/splines	Disco frizione rigido in ferodo/Rigid clutch disc lining	<b>BERTOLINI</b>	MOTOCOLTIVATORI 315	81.9033.00
<b>02368</b>	181x127mm, 23x20 EV, 20 cave/splines	Disco frizione rigido in ferodo/Rigid clutch disc lining		421 DIESEL 1C, 424 - 431 - 432 - DIESEL 2C, 428 - 450, 450 DIESEL 3 CILINDRI	81.9134.20
<b>02371</b>	184x127mm, 22x18x3,5, 10 cave/splines	Disco frizione rigido in ferodo/Rigid clutch disc lining		MOTOCOLTIVATORI BM 12, TRATTORINI 412T	81.9006.00
<b>02379</b>	110x60mm, 15x12EV, 8 cave/splines	Disco frizione rigido in ferodo/Rigid clutch disc lining		MOTOCOLTIVATORI 305	81.9221.00
<b>08093</b>	145x102mm, 26x21x3, 10 cave/splines	Disco frizione rigido in ferodo/Rigid clutch disc lining		MOTOFALCIATRICI BRF 58	81.9030.00
<b>08097</b>	178x134mm, 26x21x3, 10 cave/splines	Disco frizione rigido in ferodo/Rigid clutch disc lining		MOTOFALCIAT 124 - 125 - 126	81.9036.00
<b>02396</b>	94x61mm, 15x12EV, 8 cave/splines	Disco frizione rigido in ferodo/Rigid clutch disc lining	<b>BRUMITAL</b>	MOTOZAPPE SIMPLEX	
<b>05665</b>	110x75mm, 15x12EV, 8 cave/splines	Disco rigido sinterizzato/Sintered hard drive		MOTOZAPPE, MOTOZAPPE CON FRIZIONE DA 110MM	
<b>02368</b>	181x127mm, 23x20 EV, 20 cave/splines	Disco frizione rigido in ferodo/Rigid clutch disc lining	<b>CARON</b>	TRANSPORTER MC 20	
<b>09558</b>	160x110mm, 17x15EV, 20 cave/splines	Disco frizione rigido in ferodo/Rigid clutch disc lining		TRANSPORTER C 12	
<b>02379</b>	110x60mm, 15x12EV, 8 cave/splines	Disco frizione rigido in ferodo/Rigid clutch disc lining	<b>CARRARO</b>	CARRARINO SERIE MINI E SPECIAL, CARRARINO SERIE SUPER	5.108.501
<b>02396</b>	94x61mm, 15x12EV, 8 cave/splines	Disco frizione rigido in ferodo/Rigid clutch disc lining	<b>CARRARO ANTONIO</b>	MOTOCOLT SERIE 295 (2, MOTOCOLT SERIE 47 - 240, MOTOCOLTIVATORI 524 - 530	
<b>09558</b>	160x110mm, 17x15EV, 20 cave/splines	Disco frizione rigido in ferodo/Rigid clutch disc lining		TIGRE 2800	5.108.514
<b>02379</b>	110x60mm, 15x12EV, 8 cave/splines	Disco frizione rigido in ferodo/Rigid clutch disc lining	<b>DIESSE</b>	MT2 ERCOLE ORSETTO ERCOLINO	
<b>02396</b>	94x61mm, 15x12EV, 8 cave/splines	Disco frizione rigido in ferodo/Rigid clutch disc lining		MT2 ORSETTO	
<b>02368</b>	181x127mm, 23x20 EV, 20 cave/splines	Disco frizione rigido in ferodo/Rigid clutch disc lining	<b>DISALCAR</b>	TRANSPORTER 20H	
<b>02396</b>	94x61mm, 15x12EV, 8 cave/splines	Disco frizione rigido in ferodo/Rigid clutch disc lining	<b>EUROGARDEN</b>	MOTOZAPPA E MOTOCOL JOLLY	
<b>05665</b>	110x75mm, 15x12EV, 8 cave/splines	Disco rigido sinterizzato/Sintered hard drive		MOTOCOLTIVATORI TITANO	

Art./Ref.	Dimensioni/Sizes	Note/Note	Brand	Applicazione/Application	Rif. Orig./Orig. Ref.
<b>02364</b>	Ø 140 x 96mm, 17x15 EV, 20 cave/splines	Disco frizione rigido in ferodo/Rigid clutch disc lining	<b>FERRARI</b>	MOTOCOLTIVATORI 72 (1, MOTOCOLTIVATORI MC 68	81.9033.00
<b>02368</b>	181x127mm, 23x20 EV, 20 cave/splines	Disco frizione rigido in ferodo/Rigid clutch disc lining		MOTOCOLTIVATORI 74, TRATTORINI 74-75 1, TRATTORINO 75 2, TRATTORINO 76, TRATTORINO 94 - 95	81.9134.20
<b>02379</b>	110x60mm, 15x12EV, 8 cave/splines	Disco frizione rigido in ferodo/Rigid clutch disc lining		MOTOCOLTIVATORI 71 (1	81.9221.00
<b>09469</b>	140x96mm, 17x14x4, 6 cave/splines	Disco frizione rigido in ferodo/Rigid clutch disc lining		MOTOCOLTIVATORI MC 64	
<b>09558</b>	160x110mm, 17x15EV, 20 cave/splines	Disco frizione rigido in ferodo/Rigid clutch disc lining		MOTOCOLTIVATORI 72 2, TRATTORINI 72T	81.9304.20
<b>02367</b>	216x152mm, 22x18x3,5, 10 cave/splines	Disco frizione rigido in ferodo/Rigid clutch disc lining	<b>FIAT</b>	215R (DAL TELAIO 313667), 25CSI (TIPO A PEDALE), 25R - 25RS, 311-312-315N-331R	560446, 594614, 594916, 595725
<b>09554</b>	215x152, 25x22EV, 10 cave/splines	Disco frizione rigido in ferodo/Rigid clutch disc lining		250 - 255C - 300	4968661, 5134615, 5160429
<b>02365</b>	160x110mm, 19x15,5x3, 10 cave/splines	Disco frizione rigido in ferodo/Rigid clutch disc lining	<b>FORT</b>	CENTAURO	
<b>02379</b>	110x60mm, 15x12EV, 8 cave/splines	Disco frizione rigido in ferodo/Rigid clutch disc lining		MOTOCOLTIVATORI TIGROTTO, MOTOZAPPA MOTOFALCIATRICE	
<b>02396</b>	94x61mm, 15x12EV, 8 cave/splines	Disco frizione rigido in ferodo/Rigid clutch disc lining		MOTOCOLTIVATORI SERIE 180	
<b>02365</b>	160x110mm, 19x15,5x3, 10 cave/splines	Disco frizione rigido in ferodo/Rigid clutch disc lining	<b>GOLDONI</b>	MOTOCOLTIVATORI SPECIAL, MOTOCOLTIVATORI SPECIAL LUX, MOTOCOLTIVATORI SUPER SPECIAL	0007474
<b>02366</b>	184x127mm, 19x15,5x3, 10 cave/splines	Disco frizione rigido in ferodo/Rigid clutch disc lining		MOTOCOLTIVATORI EXPORT, MOTOCOLTIVATORI SERIE 500 700, TRATTORINI 926 - 933 RS/DT	6300045
<b>02367</b>	216x152mm, 22x18x3,5, 10 cave/splines	Disco frizione rigido in ferodo/Rigid clutch disc lining		MOTOAGR TRANSPOR EURO 40RS/SN, MOTOAGRICOLE TRANSCAR 38-40, MOTOAGRICOLE TRANSCAR 55, MOTOAGRICOLE TRANSPORTER 336, TRATTORI SERIE 1050 - 1055, TRATTORINI 1038 - 1045R - 834, TRATTORINI 236 - 238 - 240, TRATTORINI 945 RS/DT	6300038
<b>02371</b>	184x127mm, 22x18x3,5, 10 cave/splines	Disco frizione rigido in ferodo/Rigid clutch disc lining		TRATTORINI 926 - 933 RS/DT	6300048
<b>05665</b>	110x75mm, 15x12EV, 8 cave/splines	Disco rigido sinterizzato/Sintered hard drive		MOTOCOLT JOLLY PROFESSIONAL, MOTOCOLT SPECIAL LUX, MOTOCOLTIVATORI JOLLY JUNIOR, MOTOCOLTIVATORI JOLLY SUPER	6300063
<b>02363</b>	155x114mm, 16x13x3,5, 6 cave/splines	Disco frizione rigido in ferodo/Rigid clutch disc lining	<b>GRILLO</b>	MOTOCOLTIVATORI GRILLO 2	7052
<b>02379</b>	110x60mm, 15x12EV, 8 cave/splines	Disco frizione rigido in ferodo/Rigid clutch disc lining	<b>IMER</b>	MOTOZAPPA SERIE 115	
<b>02367</b>	216x152mm, 22x18x3,5, 10 cave/splines	Disco frizione rigido in ferodo/Rigid clutch disc lining	<b>ITMA</b>	4RM SIRIO - G 215 AC2	651814
<b>02370</b>	155x114mm, 17x14x4, 6 cave/splines	Disco frizione rigido in ferodo/Rigid clutch disc lining	<b>MAB</b>	MOTOCOLTIVATORE TALPA, TRATTORINO TALPA 4RM	
<b>02379</b>	110x60mm, 15x12EV, 8 cave/splines	Disco frizione rigido in ferodo/Rigid clutch disc lining	<b>NIBBI</b>	MOTOCOLTIVATORI MAJOR	
<b>05665</b>	110x75mm, 15x12EV, 8 cave/splines	Disco rigido sinterizzato/Sintered hard drive		MOTOCOLTIVATORI	
<b>02380</b>	184x127mm, 25x21EV, 15 cave/splines	Disco frizione rigido in ferodo/Rigid clutch disc lining	<b>NIBBI BRUNO-YABE</b>	TRATTORINI G119 - G219, TRATTORINI G520 - G521	NB4453

Art./Ref.	Dimensioni/Sizes	Note/Note	Brand	Applicazione/Application	Rif. Orig./Orig. Ref.
<b>02373</b>	160x108mm, 22x19x3,5, 10 cave/splines	Disco frizione rigido in ferodo/Rigid clutch disc lining	<b>PASQUALI</b>	MOTOCOLTIVATORI 921 - 922, MOTOCOLTIVATORI 923 - 924, MOTOCOLTIVATORI 933, MOTOCOLTIVATORI 934 - 917	424.002.0
<b>09457</b>	180x124mm, 29,5x23x4, 10 cave/splines	Disco frizione rigido in ferodo/Rigid clutch disc lining		MOTOCOLTIVATORE 945	945.215.0
<b>02367</b>	216x152mm, 22x18x3,5, 10 cave/splines	Disco frizione rigido in ferodo/Rigid clutch disc lining	<b>PGS</b>	TRATTORINI ROMA 500 - R55, TRATTORINI TRANSPORTER 450	02922
<b>02371</b>	184x127mm, 22x18x3,5, 10 cave/splines	Disco frizione rigido in ferodo/Rigid clutch disc lining		DUMPER 2096 - 3078, MOTOCOLTIVATORI ATTILA SUPER, MOTOCOLTIVATORI F13-F14-F16, MOTOCOLTIVATORI L15, TRATTORINI ROMA 38	
<b>02371</b>	184x127mm, 22x18x3,5, 10 cave/splines	Disco frizione rigido in ferodo/Rigid clutch disc lining	<b>POLENTES</b>	TRATTORINO PIERRE	
<b>02365</b>	160x110mm, 19x15,5x3, 10 cave/splines	Disco frizione rigido in ferodo/Rigid clutch disc lining	<b>RANDI</b>	MOTOCOLTIVATORE 2500 - 2500 SJ, MOTOCOLTIVATORE 3000-3500-4000, MOTOCOLTIVATORE 6000 JUNIOR	
<b>02366</b>	184x127mm, 19x15,5x3, 10 cave/splines	Disco frizione rigido in ferodo/Rigid clutch disc lining		MOTOCOLTIVATORI 3600Q, TRATTORINI R421 - R424	
<b>02396</b>	94x61mm, 15x12EV, 8 cave/splines	Disco frizione rigido in ferodo/Rigid clutch disc lining	<b>RAPID</b>	MOTOCOLTIVATORE EURO 3	
<b>02379</b>	110x60mm, 15x12EV, 8 cave/splines	Disco frizione rigido in ferodo/Rigid clutch disc lining	<b>SEP</b>	MOTOFALCIATRICE 150 - 200	210.962
<b>02367</b>	216x152mm, 22x18x3,5, 10 cave/splines	Disco frizione rigido in ferodo/Rigid clutch disc lining	<b>VALPADANA</b>	TRATTORINI 4RM 350 - 4RM 450	104951
<b>02370</b>	155x114mm, 17x14x4, 6 cave/splines	Disco frizione rigido in ferodo/Rigid clutch disc lining		MOTOCOLTIVATORI VMC 14	104337
<b>02371</b>	184x127mm, 22x18x3,5, 10 cave/splines	Disco frizione rigido in ferodo/Rigid clutch disc lining		MOTOCOLTIVATORI PADANO D12-D14, MOTOCOLTIVATORI PADANO VMC 18, TRATTORINI 4RM20	102770
<b>02379</b>	110x60mm, 15x12EV, 8 cave/splines	Disco frizione rigido in ferodo/Rigid clutch disc lining		MOTOCOLTIVATORI VMC160 - VMC12	108783



# 1.7.17 Dischi freno

Brake discs

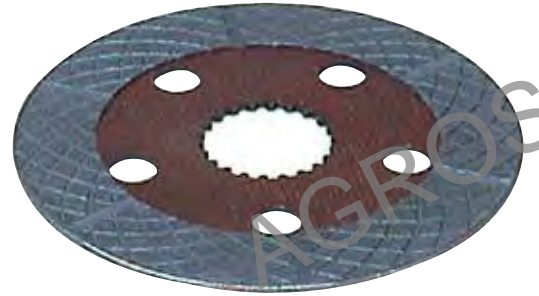

**ama**

**Ricambi & accessori per macchine agricole**  
SPARE PARTS & ACCESSORIES FOR AGRICULTURAL MACHINE

Tutti gli articoli della presente sezione, prodotti da AMA SPA e/o da terzi per conto di AMA, sono adattabili ("non originali") alle marche indicate ai sensi di quanto previsto dal REG. CE n. 1400/2002. I diritti sui marchi citati appartengono ai legittimi proprietari e il loro uso ha l'esclusiva finalità di consentire all'utilizzatore la comparazione dei diversi prodotti.  
All items of this section, manufactured by AMA SPA and/or any third party on behalf of AMA, are adaptable ("non-original") to the brands listed under the provisions of the REG. CE n. 1400/2002. The rights on the trademarks belong to their respective owners and their usage is only aimed to allow the user to compare different products.

**DISCHI FRENO ADATTABILI**

DISQUES FREIN ADAPTABLE  
BRAKE-DISCS ADAPTABLE TO  
BREMSSCHEIBEN PASSEND ZU  
PLATOS FRENO ADAPTABLE

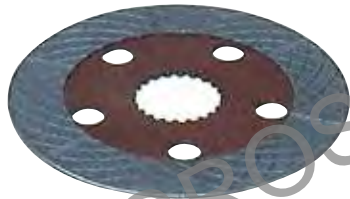

Art./Ref.	Brand	Applicazione/Application	Rif. Orig./Orig. Ref.	Note/Note
10580	FIAT	45.66, 45.66DT, 45.76, 50.66, 50.66DT, 55.66, 55.76, 55.86, 56.66S, 60.66, 60.76, 60.86, 65.66, 70.66, 70.76, 70.86, 72.86, 80.66, 80.76, 82.86	5159830	-
10581		45.66-45.66 DT, 45.66S-45.66S DT, 45.76 V, 50.66-50.66 DT, 50.66S-50.66S DT, 50.86 V, 50.86 V DT, 50.86S V, 50.86S V DT, 55.46-55.46 DT, 55.56-55.56 DT, 55.66 DT LP, 55.66 LP, 55.66-55.66 DT, 55.66S-55.66S DT, 55.76 F, 55.76 F DT, 55.76 V, 55.76 V DT, 55.86 F, 55.86 F DT, 55.86 V, 55.86 V DT, 55.86S V, 55.86S V DT, 56.66S-56.66S DT, 60.46-60.46 DT, 60.56-60.56 DT, 60.66 F DT, 60.66 LP, 60.66 LP DT, 60.66-60.66 DT, 60.66F, 60.66S-60.66S DT, 60.76 F, 60.76F DT, 60.86 F, 60.86 F DT, 60.86 V, 60.86 V DT, 60.86S V, 60.86S V DT, 62.86 F, 62.86 F DT, 65.46-65.46 DT, 65.56-65.56 DT, 65.66-65.66 DT, 65.66S-65.66S DT, 70.56-70.56 DT, 70.66 F, 70.66 V, 70.66-70.66 DT, 70.66S-70.66S DT, 70.76 F, 70.76 F DT, 70.76 LP, 70.76 LP DT, 70.76 V, 70.86 V, 70.86 V DT, 70.86S V, 70.86S V DT, 72.86 F, 72.86 F DT, 72.86 LP, 72.86 LP DT, 80.66 F DT, 80.66-80.66 DT, 80.66F DT, 80.66S-80.66S DT, 80.76 F, 80.76 F DT, 82.86 F, 82.86 F DT, 82.86 LP	5119327	-
12930		100.90, 100.90 DT, 110.90, 110.90 DT, 680, 780, 880, 90.90, 90.90 DT	4993584, 4993585	-
12931		55.88, 55.88 DT, 55.90, 55.90 DT, 60.88, 60.88 DT, 60.90, 60.90 DT, 60.93, 60.93 DT, 60.94, 60.94 DT, 65.88, 65.88 DT, 65.90, 65.90 DT, 65.93, 65.93 DT, 65.94, 65.94 DT, 680, 70.88, 70.88 DT, 70.90, 70.90 DT, 72.93, 72.93 DT, 72.94, 72.94 DT, 780, 80.88, 80.88 DT, 80.90, 80.90 DT, 82.93, 82.93 DT, 82.94, 82.94 DT, 85.90, 85.90 DT, 88.93, 88.93 DT, 88.94, 88.94 DT, 880	4997208, 4999494, 4999495	-
12932		115.90-115.90DT, 1180, 1580, 1380, 1880, 130.90-130.90DT, 140.90-140.90DT, 160.90-160.90DT, 180.90-180.90DT	5102783	-
12933		850 DTS-1000 DTS-1300 DTS	44011292, 8995071	-
12934		850 DTS-1000 DTS-1300 DTS	44011293, 8995072	-
14272		55.88, 55.88DT, 55.90, 55.90DT, 60.88, 60.88DT, 60.90, 60.90DT, 60.93, 60.93DT, 60.94, 60.94DT, 65.88, 65.88DT, 65.90, 65.90DT, 65.93, 65.93DT, 65.94, 65.94DT, 70.88, 70.88DT, 70.90, 70.90DT, 72.93, 72.93DT, 72.94, 72.94DT, 80.88, 80.88DT, 80.90, 80.90DT, 82.93, 82.93DT, 82.94, 82.94DT, 85.90, 85.90DT, 88.93, 88.93DT, 88.94, 88.94DT	5110138	-
15591		615, 715, 650, 750	44092218, 5160738, 9023259	-
26162		115.90-115.90 DT, 130.90-130.90 DT, 140.90-140.90 DT, 160.90-160.90 DT, 180.90-180.90 DT	5146315	-
36140	F100-F100DT, F110-F110DT, F115-F115DT, F120-F120DT, F130-F130DT, F140-F140DT	5154521	-	
42266	F100-F100 DT, F110-F110 DT, F115-F115 DT, F120-F120 DT, F130-F130 DT, F140-F140 DT	5146036	-	
10580	FORD	3010, 3435, 3830, 3935, 4010, 4030, 4135, 4230, 4430	5159830	-
10581		3010S-4010S-5010S, 3435, 3935, 4135, 3830-4030-4230-4430	5119327	-
12931		4635, 4835, 5635, 6635, 7635	4997208	-
12932		8430-8630-8830	5102783	-
14272		4635, 4835, 5635, 6635, 7635	5191349	-
22219		5000, 5110, 5600, 5610, 5900, 6410, 6600, 6610, 6700, 6710, 6810, 7000, 7600, 7610, 7700, 7710, 7810, 7910, 8210	81818854	Ø 9" - 228 mm > 5.88
26162		8430, 8630, 8830	5146315	-
36140		8160-8260-8360-8560	5154521	-
42266		8160, 8260, 8360, 8560	5146036	-
42521		MAJOR, SUPER MAJOR, POWER MAJOR	81717001	Freno a secco principale - Main dry brake disc
42528		2810, 2910, 3910, 4110, 4610, 3230, 3430, 3930, 4130, 4630, 4830, 5030, 3930H	83983209, C5N-N2A097B	-

Art./Ref.	Brand	Applicazione/Application	Rif. Orig./Orig. Ref.	Note/Note
16020	HURLIMANN	H362, H372, H466, H468, H476, H476.4, H478, H478.4, H488T, H496T, H5116, H6130, H6136, H6160, H6170T, HCLUB 468.4, HELITE 4105, 6115, 6135, HXB ELITE 6115, 6135, HXF 361, 476, 481, 491, MASTER 6165, 6190, MASTER HP/SX 1002, 1350, 1500, PRESTIGE 468, 478, 488, PRESTIGE H468, H478, H488, XT 908, 909, 910.4, 910.6, 911, XT 913	154.5459.0/10	Disco freno posteriore/ Rear brake disc
16074		H351, H355FR, H360 NOCAB	256.5434.0/10	Disco freno posteriore/ Rear brake disc
26692		H362, H372, HXF 361, 476, 481, 491	008.4661.0	Disco freno posteriore/ Rear brake disc
26694		HXE305	008.5267.2	Disco freno posteriore/ Rear brake disc
26699		ELITE 4105, H476, H478.4, H488T, HT 908, 909, PRESTIGE 478, 488	009.7067.2	
16020	LAMBORGHINI	1106, 1306, 1506, 1706, 674.70N, 674.5, 774.80N, 774.5, R674, 674.70, 674.70GP, R774, 774.80, 874.90GP, R965.100, RACING 150, 165, 190, RACING HI.PER	154.5459.0/10	Disco freno posteriore/ Rear brake disc
16074		583, 653, 653FR, 654, 660, 660DT, 660FR, 660V, R683, R684, R724, R684FR, R775 FR, R775V, R550, R 550DT	256.5434.0/10	Disco freno posteriore/ Rear brake disc
26692		700, 600	008.4661.0	Disco freno posteriore/ Rear brake disc
26694		CRONO 554.50	008.5267.2	Disco freno posteriore/ Rear brake disc
26699		FORMULA 105P, PREMIUM 774.5, R874.90T, PREMIUM 850, 950, R774 774.80, PREMIUM 874.90GP, 774.80N	009.7067.2	-
10580	LANDINI	ATLAS:100, ATLAS:75, ATLAS:80, ATLAS:85, ATLAS:90, GLOBUS: 75, GLOBUS:50, GLOBUS:55, GLOBUS:60, GLOBUS:65, GLOBUS:70, GLOBUS:80	3537089M1	-
41072	MASSEY FERGUSON	3070 (>B082009), 3075 (>B082009), 3080 (>B082009), 3085, 3090, 3095, 6150, 6160, 6170, 6180, 6190	3617652M91	Disco bronzo - Brake disc 13 Cave - Spline
41080		65, 155, 158, 165, 175, 178, 765	1753117M91, 3609098M1	Disco freno - Brake disc Secco - Dry type 7" / 180 mm
41087		2620, 2625, 2640, 2645, 2680, 2685, 3610, 3630, 3680, 6180, 3115 (<B126020), 3120 (<B126020), 3120T (<B126020), 3125 (<B126020), 3140 (<B126020), 3635 (<B126025), 3645 (<B126025), 3655 (<B126025), 3660 (<B126025), 3670 (<B126020), 8110, 8120, 8130, 8140, 8150	3386897M92	Disco freno - Brake disc 14 Cave - Spline 350 x 70 x 7,7 mm/Brake disc 14 Splines 350 x 70 x 7,7 mm
41088		3070 (<B126033), 3080, 3090, 3085 (<B126033), 3095 (<B126033)	3386896M92	Disco freno - Brake disc 13 Cave - Spline 355 x 64 x 7,7 mm/Brake disc 13 Spline 355 x 64 x 7,7 mm
10580	NEW HOLLAND	TD60, TD65, TD70, TD75, TD80, TD85, TD95	5159830	-
10581		665TL, L620-L630, T4.55-T4.65-T4.75, TD3.50, TD4020F-TD4030F-TD4040F, TD5010, TD5020, TD503, TD5040, TD5050, TD55D-TD60D-TD65D-TD70D-TD75D, TD60-TD70-TD80-TD90-TD95, TD65B, TD65F-TD75F-TD85F, TD80D-TD90D-TD95D, TD85D-TD85F, TK80.66 DT, TT55-TT65-TT65D-TT75	5119327	-
12931		L60, L65, L70, L75, L85, L95, TL100, TL55F, TL65, TL65A, TL65F, TL70, TL75F, TL80, TL90	4997208	-
14272		L60-L65-L75-L85-L95, T5030, T5040, T5050, T5060, T5070, TL100A, TL55F, TL55F-TL65F-TL75F, TL60E, TL65-TL70-TL80-TL90-TL100, TL65A, TL65F, TL70A, TL75E, TL75F, TL80A, TL85E, TL90A, TL95E	5110138, 5191349	-
36140		M100-M115-M135-M160, TM115-TM125-TM135-TM150-TM165	5154521	-
42266		M115, M135, M160, TM110, TM115, TM120, TM125, TM130, TM135, TM140, TM150, TM155, TM165, TM175, TM180, TM190, TM7010, TM7020, TM7030, TM7040	5146036	-
16020	SAME	ANTARES 100, 110, 130, ANTARES II 110, 130, ASTER 70, CENTAURO 70EX, 70SP, CENTURION 75EX, 750SP, EXPLORER 65.70, 65.70SP, EXPLORER 75.80, 75.80SP, 80SP, EXPLORER 90SP, 90SP/LP, 90T, EXPLORER II 70, 70SP, 80.90	154.5459.0/10	Disco freno posteriore/ Rear brake disc
16074		FRUTTETO 60, 75, SOLAR 50, 60, VIGNERON 62, 75	256.5434.0/10	Disco freno posteriore/ Rear brake disc
26692		ASTER 60, 70, FRUTTETO II 60, 75, 85, ROW CROP 80, SATURNO 80, 80 SINCR0, TAURUS 60, VIGNERON 60, 70	008.4661.0	Disco freno posteriore/ Rear brake disc
26694		ARGON 50	008.5267.2	Disco freno posteriore/ Rear brake disc
26699		ANTARES 100, 110, 130, EXPLORER 75.80, 75.80SP, EXPLORER 80.90II, 80.80SP/LP, EXPLORER 90.90SP/LP, 90T, SILVER 80.90	009.7067.2	-



# 1.7.18 Bandelle freno

Brake flaps



**ama**

**Ricambi & accessori per macchine agricole**  
SPARE PARTS & ACCESSORIES FOR AGRICULTURAL MACHINE

Tutti gli articoli della presente sezione, prodotti da AMA SPA e/o da terzi per conto di AMA, sono adattabili ("non originali") alle marche indicate ai sensi di quanto previsto dal REG. CE n. 1400/2002. I diritti sui marchi citati appartengono ai legittimi proprietari e il loro uso ha l'esclusiva finalità di consentire all'utilizzatore la comparazione dei diversi prodotti. All items of this section, manufactured by AMA SPA and/or any third party on behalf of AMA, are adaptable ("non-original") to the brands listed under the provisions of the REG. CE n. 1400/2002. The rights on the trademarks belong to their respective owners and their usage is only aimed to allow the user to compare different products.

**BANDELLE FRENO ADATTABILI**

SANGLES DE FREIN ADAPTABLE

BRAKE BANDS ADAPTABLE

BREMSBÄNDEN PASSEND ZU

CINCHO DE FRENO ADAPTABLE

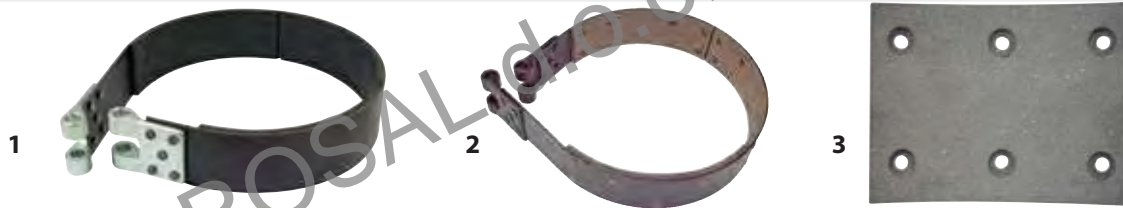

Art./Ref.	Pos	Dimensioni/Sizes	Tipo/Type	Modello/Model	Brand	Applicazione/Application	Rif. Orig./Orig. Ref.
08152	1	Ø int.227, h.56 - occhiello Ø est.25, Ø int.14	Impasto/Moulded	Incollata	AGRIFULL	55, 55DT, 55.60, 65, 65DT	-
26705	2	Ø int.261, h.50 - occhiello Ø est.22, Ø int.14	Tessuto/Woven	Rivettata		C60, C70	4965138, 4996577
85548	1	Ø int.261, h.50 - occhiello Ø est.22, Ø int.14	Impasto/Moulded	Incollata		60C, 70C, 70C SPECIAL	4965138, 4996577, 4996580
91015	2	Ø int.261, h.50 - occhiello Ø est.22, Ø int.14	Tessuto/Woven	Rivettata		80.50 C	-
08154	1	Ø int.261, h.50 - occhiello Ø est.25, Ø int.14	Impasto/Moulded	Incollata		55CV-CF, 70C SPECIAL, 80.50C	5155112, 5161640, 5162002
10564	3	210x50x6,0 - 7 fori	Tessuto/Woven	Forato		60C, 70C, 70C SPECIAL, 80.50C	-
91016	2	Ø int.261, h.60 - occhiello Ø est.25, Ø int.14	Tessuto/Woven	Rivettata		80.76C, 60C, 70C, 80C, 80C, 80.46C, 80.56C, 80.66C	-
91017	1	Ø int.261, h.60 - occhiello Ø est.25, Ø int.14	Impasto/Moulded	Incollata		80.76C, 60C, 70C, 80C, 80C, 80.46C, 80.56C, 80.66C	5161638
08155	1	Ø int.261, h.65 - occhiello Ø est.25, Ø int.14	Impasto/Moulded	Incollata		60C, 60CL, 70C, 70CL, 80C, 80.46C, 80.56C, 80.66C, 80.76C	5164940
91018	2	Ø int.261, h.65 - occhiello Ø est.25, Ø int.14	Tessuto/Woven	Rivettata		80.76C, 60C, 70C, 80C, 80C, 80.46C, 80.56C, 80.66C	-
91040	3	210x60x6,0 - 7 fori	Tessuto/Woven	Forato	80.76C, 60C, 70C, 80C, 80C, 80.46C, 80.56C, 80.66C	-	
91019	2	Ø int.274, h.90 - occhiello Ø est.25, Ø int.14	Tessuto/Woven	Rivettata	CARRARO	6300/655	101169
91041	3	203x90x6,0 - 12 fori	Tessuto/Woven	Forato		6300/655	101183
26705	2	Ø int.261, h.50 - occhiello Ø est.22, Ø int.14	Tessuto/Woven	Rivettata		450C, 450CL, 455C, 505C, 555C, 655C, 3500C, 4500C	86393
85548	1	Ø int.261, h.50 - occhiello Ø est.22, Ø int.14	Impasto/Moulded	Incollata		3500C, 4500C, 6300C, 450C, 450CL, 455C, 505C, 555C	83693
10564	3	210x50x6,0 - 7 fori	Tessuto/Woven	Forato		3500C, 4500C, 6300C, 450C, 450CL, 455C, 505C, 555C	-
91020	2	Ø int.241, h.50	Tessuto/Woven	Rivettata		50.5, 620.5 (L-M-N-S-V)	660188
91042	2	210x50x7,0 - 7 fori	Tessuto/Woven	Forato		50.5, 620.5 (L-M-N-S-V)	650988
91021	3	Ø int.157, h.38 - occhiello Ø est.17, Ø int.10	Tessuto/Woven	Rivettato		FIAT	200R, 211R, 215R, 221R, 231R, 241R, 220
91022	1	Ø int.157, h.38 - occhiello Ø est.17, Ø int.10	Impasto/Moulded	Incollata	200R, 211R, 215R, 221R, 231R, 241R, 220		-
91043	3	192x38x5,0 - 7 fori	Tessuto/Woven	Forato	200R, 211R, 215R, 221R, 231R, 241R, 220		559594
91023	2	Ø int.167, h.38 - occhiello Ø est.17, Ø int.10	Tessuto/Woven	Rivettata	250, 300, 300DT, 350, 350N, 350S, 350NS, 420, 420DT		-
08156	1	Ø int.167, h.38 - occhiello Ø est.17, Ø int.10	Impasto/Moulded	Incollata	250, 250, 300, 300DT, 350, 350N, 30, 40, 300, 350, 420, 350S, 350NS, 420, 420DT		4966601, 4967626, 4973446, 4977668, 4989321, 4989332, 4996426, 4996427, 4996601, 4996602, 5161240, 597873
91044	3	204x38x5,0 - 7 fori	Tessuto/Woven	Forato	250, 300, 300DT, 350, 350N, 350S, 350NS, 420, 420DT		597871, 597872
91024	2	Ø int.212, h.50 - occhiello Ø est.22, Ø int.14	Tessuto/Woven	Rivettata	311R, 312, 315, 331R, 411R-T, 418, 431R		582691
14867	3	Ø int.212, h.50 - occhiello Ø est.22, Ø int.14	Impasto/Moulded	Incollata	311R, 312, 315, 331R, 411R-T, 418, 431R		5161239
15321	3	171x50x6,0 - 7 fori	Tessuto/Woven	Forato	311R, 312, 315, 331R, 411R-T, 418, 431R		562286
91025	2	Ø int.227, h.50 - occhiello Ø est.22, Ø int.14	Tessuto/Woven	Rivettata	450 (DAL 04/80), 450DT (DAL 04/80), 480, 480S, 480 VIGNETO, 480.80, 480.80DT, 480.80 VIGNETO, 500, 500DT, 540, 540DT, 550, 550DT, 600, 600DT, 640, 640DT		4954030, 4963008
91026	1	Ø int.227, h.50 - occhiello Ø est.22, Ø int.14	Impasto/Moulded	Incollata	450 (DAL 04/80), 450DT (DAL 04/80), 480, 480S, 480 VIGNETO, 480.80, 480.80DT, 480.80 VIGNETO, 500, 500DT, 540, 540DT, 550, 550DT, 600, 600DT, 640, 640DT		4980314, 4996432, 5107956
15389	3	183x38x5,0 - 7 fori	Tessuto/Woven	Forato	450 (DAL 04/80), 450DT (DAL 04/80), 480, 480S, 480 VIGNETO, 480.80, 480.80DT, 480.80 VIGNETO, 500, 500DT, 540, 540DT, 550, 550DT, 600, 600DT, 640, 640DT		596209
91027	2	Ø int.227, h.56 - occhiello Ø est.22, Ø int.14	Tessuto/Woven	Rivettata	450 (DAL 04/80), 450DT (DAL 04/80), 480, 480S, 480 VIGNETO, 480.80, 480.80DT, 480.80 VIGNETO, 500, 500DT, 540, 540DT, 640, 640DT		-
91028	1	Ø int.227, h.56 - occhiello Ø est.22, Ø int.14	Impasto/Moulded	Incollata	450 (DAL 04/80), 450DT (DAL 04/80), 480, 480S, 480 VIGNETO, 480.80, 480.80DT, 480.80 VIGNETO, 500, 500DT, 540, 540DT, 640, 640DT		5107958
91045	3	183x56x6,0 - 7 fori	Tessuto/Woven	Forato	450 (DAL 04/80), 450DT (DAL 04/80), 480, 480S, 480 VIGNETO, 480.80, 480.80DT, 480.80 VIGNETO, 500, 500DT, 540, 540DT, 640, 640DT		-

Art./Ref.	Pos	Dimensioni/Sizes	Tipo/Type	Modello/Model	Brand	Applicazione/Application	Rif. Orig./Orig. Ref.
17744	1	Ø int.227, h.50 - occhio Ø est.25, Ø int.14	Impasto/Moulded	Incollata		440, 440DT, 440 VIGNETO, 450, 450DT, 480S, 480.8, 480.8DT, 480.8 VIGNETO, 550, 550DT, 600, 600DT	4954030, 4954120, 4963008, 4963274, 4965026, 4965029, 4973967, 4975221, 4980110, 4980111, 4980314, 4980315, 4996429, 4996430, 4996432, 4996433, 5102203, 5107956, 5112676, 5160713, 596207
08152	1	Ø int.227, h.56 - occhio Ø est.25, Ø int.14	Impasto/Moulded	Incollata		450, 450DT, 480S, 480.8, 480.8DT, 480.8V, 500, 500DT, 500S, 540, 540DT, 540S, 640, 640DT, 446, 446DT, 55.46DT, 55.46SUPER, 60.46DT, 65.46DT, 65.46	4996436, 5160714
91029	2	Ø int.241, h.50 - occhio Ø est.22, Ø int.16	Tessuto/Woven	Rivettata		25C, 25CL, 25CF, 25CS	44981752
26710	3	194x50x6,0 - 7 fori	Tessuto/Woven	Forato		25C, 25CL, 25CF, 25CS	536464
26705	2	Ø int.261, h.50 - occhio Ø est.22, Ø int.14	Tessuto/Woven	Rivettata		311C, 332C, 351C, 352C, 400C, 411C, 411CL, 451C, 455C SUPER, 455C, 505C, 505C SUPER, 555C, 605C, 605C SUPER	4965138, 4996577, 4996578, 593873
85548	1	Ø int.261, h.50 - occhio Ø est.22, Ø int.14	Impasto/Moulded	Incollata		311C, 332C, 351C, 352C, 355C, 400C, 411C, 411CL, 451C, 455C, 455C SUPER, 505C, 505C SUPER	4965138, 4996577
91030	2	Ø int.261, h.56 - occhio Ø est.22, Ø int.14	Tessuto/Woven	Rivettata		555C, 605C, 605C SUPER, FL4 C, FL4 C IDROVERT, FL4 D IDROVERT, FL4 D M, FL55	-
91031	1	Ø int.261, h.56 - occhio Ø est.22, Ø int.14	Impasto/Moulded	Incollata		555C, 605C, 605C SUPER, FL4 C, FL4 C IDROVERT, FL4 D IDROVERT, FL4 D M, FL55	-
91015	2	Ø int.261, h.50 - occhio Ø est.25, Ø int.14	Tessuto/Woven	Rivettata		355C, 400C, 411C, 411CL, 451C, 455C, 455C SUPER, 505C, 505C SUPER, 55.65 FRUTTETO, 55.65 MONTAGNA, 55.65 VIGNETO, 55.75 FRUTTETO, 55.75 MONTAGNA, 55.75 VIGNETO	-
08154	1	Ø int.261, h.50 - occhio Ø est.25, Ø int.14	Impasto/Moulded	Incollata		335C, 400C, 411C, 411CL, 451C, 455C, 455C SUPER, 505C, 505C SUPER, 55.65 FRUTTETO, 55.65 MONTAGNA, 55.65 VIGNETO, 55.75 FRUTTETO, 55.75 MONTAGNA, 55.75 VIGNETO, 60.65 VIGNETO, 60.75 VIGNETO	47134120, 4996580, 5155112, 5161640, 5162002
10564	3	210x50x6,0 - 7 fori	Tessuto/Woven	Forato		311C, 332C, 351C, 352C, 355C, 355C, 400C, 411C, 411CL, 451C, 400C, 411C, 411CL, 451C, 455C, 455C SUPER, 505C, 505C SUPER, 455C, 455C SUPER, 505C, 505C SUPER, 55.65 FRUTTETO, 55.65 MONTAGNA, 55.65 VIGNETO, 55.75 FRUTTETO, 55.75 MONTAGNA, 55.75 VIGNETO	569604, 76028900
91016	2	Ø int.261, h.60 - occhio Ø est.25, Ø int.14	Tessuto/Woven	Rivettata	FIAT	60.65 FRUTTETO, 60.65 MONTAGNA, 60.75 FRUTTETO, 60.75 MONTAGNA, 70.65, 70.65 MONTAGNA, 70.75, 70.75 MONTAGNA, 80.65, 80.75	-
91017	1	Ø int.261, h.60 - occhio Ø est.25, Ø int.14	Impasto/Moulded	Incollata		60.65 FRUTTETO, 60.65 MONTAGNA, 60.75 FRUTTETO, 60.75 MONTAGNA, 70.65, 70.65 MONTAGNA, 70.75, 70.75 MONTAGNA, 80.65, 80.75	5123188, 5161638
08155	1	Ø int.261, h.65 - occhio Ø est.25, Ø int.14	Impasto/Moulded	Incollata		60.65 FRUTTETO, 60.65 MONTAGNA, 60.75 FRUTTETO, 60.75 MONTAGNA, 70.65, 70.65 MONTAGNA, 70.75, 70.75 MONTAGNA, 80.65, 80.75	5164940
91018	2	Ø int.261, h.65 - occhio Ø est.25, Ø int.14	Tessuto/Woven	Rivettata		60.65 FRUTTETO, 60.65 MONTAGNA, 60.75 FRUTTETO, 60.75 MONTAGNA, 70.65, 70.65 MONTAGNA, 70.75, 70.75 MONTAGNA, 80.65, 80.75	-
91040	3	210x60x6,0 - 7 fori	Tessuto/Woven	Forato		60.65 FRUTTETO, 60.65 MONTAGNA, 60.75 FRUTTETO, 60.75 MONTAGNA, 70.65, 70.65 MONTAGNA, 70.75, 70.75 MONTAGNA, 80.65, 80.75	-
10560	2	Ø int.261, h.56 - occhio Ø est.25, Ø int.14	Tessuto/Woven	Rivettata		FL4 C, FL4 C IDROVERT, FL4 D IDROVERT, FL4 D M, FL55	4992432, 4992433, 4996583, 4996584, 76019960, 76028859, 76037913, 79020415, 79020416
08158	1	Ø int.261, h.56 - occhio Ø est.25, Ø int.14	Impasto/Moulded	Incollata		FL4 C, FL4 C IDROVERT, FL4 D IDROVERT, FL4 D M, FL55, FL4C, FL4C IDROVERT, FL4D IDROVERT, FL4 LM	4992432, 4992433, 4996583, 4996584, 76019960, 76028859, 76037913, 79020415, 79020416
91046	3	210x56x6,0 - 7 fori	Tessuto/Woven	Forato		555C, 605C, 605C SUPER, FL4 C, FL4 C IDROVERT, FL4 D IDROVERT, FL4 D M, FL55	-
91032	2	Ø int.309, h.92	Tessuto/Woven	Rivettata		100.55, 85.55, 855C, 95.55, 955C	-
91047	3	122x92x6,5 - 6 fori	Tessuto/Woven	Forato		100.55, 85.55, 855C, 95.55, 955C	-
10561	2	Ø int.294, h.90	Tessuto/Woven	Rivettata		805C, FL6, 655C, 805C	4954104, 4954131, 4956111, 5161595, 595485, 599217
16435	3	118x90x6,0 - 6 fori	Tessuto/Woven	Forato		FL6, 655C, 805C	-
15709	2	Ø int.343, h.92	Tessuto/Woven	Seminastro inferiore - Rivettata		80C, 90C, 100C, 120C, 1355C, FA100, FA150, FL8, FL8 C, 70C	76029182

Art./Ref.	Pos	Dimensioni/Sizes	Tipo/Type	Modello/Model	Brand	Applicazione/Application	Rif. Orig./Orig. Ref.
15710	2	Ø int.343, h.92	Tessuto/Woven	Seminastro superiore - Rivettato	FIAT	80C, 90C, 100C, 120C, 1355C, FA100, FA150, FL8, FL8 C, 70C	76028871
10565	3	234x92x6,5 - 6 fori	Tessuto/Woven	Forato		76028870	
91035	2	Ø int.341, h.90	Bagno d'olio/ Wet use	Rivettata		FL10 B, FL10 C, FL12, FL14 B, FL14 C, FL14 D, FD175	79004392, 79004393, 84146193
91048	3	171x90x6,5 - 10 fori	Tessuto/Woven	Forato		FL10 B, FL10 C, FL12, FL14 B, FL14 C, FL14 D, FD175	4970722, 84146194
91049	3	171x90x6,0 - 10 fori	Tessuto/Woven	Forato		FL10 B, FL10 C, FL12, FL14 B, FL14 C, FL14 D, FD175	76054807
91050	3	212x90x6,5 - 10 fori	Tessuto/Woven	Forato		10, 14, FD14, FD14 E, FD145, FD175, FL145, FL175, FL10, FL14, FA200, FP40, PL40, FD175	13852540, 13879740, 76029177, 76032297, 76040320, 76047410, 76048102, 79011420, 84146194
91051	3	153x120x8,0 - 10 fori	Tessuto/Woven	Forato		FD20, FL20, FP60	
12075	2	Ø int.261 - h.50	Tessuto/Woven	Rivettata	LANDINI	C4500, C4830, C5500, C5830, C6500, C6830, CF4830, CF5030, CF5830, CF6030, CF6060, CF6830	182.761M91
10564	3	210x50x6,0 - 7 fori	Tessuto/Woven	Forato		C14000, C4500, C4830 F, C5000, C5500, C5830 F, C6000, C6030F, C6500, C6830 F, CL5000 SPECIAL, CL6000, TL6 C	1423488M1, 3308991M91
12076	2	Ø int.294, h.60 - occhio Ø est.25, Ø int.14	Tessuto/Woven	Rivettata		C7800, C7830	3300299M93
91052	3	118x60x6,0 - 5 fori	Tessuto/Woven	Forato		C7800, C7830	3300302M2, 3309388M1
91038	2	Ø int.261, h.60	Tessuto/Woven	Rivettata		C7800, C7830	3308992M91
91040	3	210x60x6,0 - 7 fori	Tessuto/Woven	Forato		C7800, C7830	3549084M1
91037	2	Ø int.241, h.50	Tessuto/Woven	Rivettata	LAMBORGHINI	C230 S, C340	400.5005.5
26710	3	194x50x6,0 - 7 fori	Tessuto/Woven	Forato		C230 S, C340	431.5412.0
26707	2	Ø int.241, h.60	Tessuto/Woven	Rivettata		C483 C, C483 S, C503, C553, C554 COMPACT, C583, C603, C653, C664 COMPACT, C683	424.5411.4
26851	3	188x60x6,0 - 7 fori	Tessuto/Woven	Forato		C484 C, C483 S, C503, C553, C554 COMPACT, C583, C603, C653, C664 COMPACT, C683	424.5412.0
26703	2	Ø int.261, h.50	Tessuto/Woven	Rivettata		C483 L, C483, C503, C553 S, C553, C583, C603, C653	433.5411.4
10564	3	210x50x6,0 - 7 fori	Tessuto/Woven	Forato		C483 L, C483, C503, C553 S, C483C-C483S, C503-C533-C554 COMPACT, C553, C583, C603, C653, C583-C603-C653, C664 ERGOMATIC - C683, R230, R230 DT, R340, R340 DT	400.1815.7
12075	2	Ø int.261 - h.50	Tessuto/Woven	Rivettata	MASSEY FERGUSON	MF134C, MF144C, MF154C, MF164C, MF164, MF174C, MF234CF, MF254C, MF254CF, MF274C, MF274CF	1824761M91
10564	3	210x50x6,0 - 7 fori	Tessuto/Woven	Forato		MF134C, MF144C, MF154C, MF164C, MF164, MF174C, MF234CF, MF254C, MF254CF, MF274C, MF274CF	1423488M1, 3308991M91
12076	2	Ø int.294, h.60 - occhio Ø est.25, Ø int.14	Tessuto/Woven	Rivettata		MF194 C, MF294 C	3300299M93
91052	3	118x60x6,0 - 5 fori	Tessuto/Woven	Forato		MF194 C, MF294 C	3300302M2, 393354X1
91039	2	Ø int.261, h.60	Tessuto/Woven	Rivettata		MF200 C, MF244 C	1452972M91, 2739931M91
91040	3	210x60x6,0 - 7 fori	Tessuto/Woven	Forato		MF200 C, MF244 C	1452976M1, 2739942M1
26700	2	Ø int.261, h70	Tessuto/Woven	Rivettata	SAME	CENTAURO 55, CENTAURO 60, CENTAURO 65, CORSARO 70, CORSARO 70 SYNCRO	157.5411.3/10
26706	2	Ø int.261, h.60	Tessuto/Woven	Rivettata		CENTAURO 55, CENTAURO 60, CENTAURO 65, CORSARO 70	157.5411.3/10
26740	2	Ø int.228, h.70	Tessuto/Woven	Rivettata		FALCON, MINITAURO 50, MINITAURO 55, MINITAURO 60 FRUTTETO, MINITAURO 60 VIGNETO	146.5411.3/20
26741	3	210x60x6,0 - 7 fori	Tessuto/Woven	Forato		CENTAURO 55, CENTAURO 60, CENTAUARO 65, CORSARO 70, CORSARO 70 SYNCRO	135.5412.0
26742	3	178x60x6,0 - 7 fori	Tessuto/Woven	Forato		CENRTAURO 65, CORSARO 70, CENTAURO 55, CENTAURO 60, FALCON, MINITAURO 50, MINITAURO 55, MINITAURO 60 FRUTTETO, MINITAURO 60 VIGNETO	146.5412.0, 157.5412.0
26707	2	Ø int.241, h.60	Tessuto/Woven	Rivettata		CONDOR, FALCON C (DA TEL.4000), SOLAR 55C COMPACT, SOLAR 60C	424.5411.4
26851	3	188x60x6,0 - 7 fori	Tessuto/Woven	Forato		CONDOR, FALCON (DA TEL.4000), SOLAR 55C COMPACT, SOLAR 50C	424.5412.0
26705	3	Ø int.261, h.50 - occhio Ø est.22, Ø int.14	Tessuto/Woven	Rivettata		FALCON C, MINITAURUS 60C, TAURUS C	0.160.5411.2
10564	3	210x50x6,0 - 7 fori	Tessuto/Woven	Forato		FALCON (FINO TEL. 4000), MINITAURUS 60C, TAURUS C	255.2214.6



# 1.7.19 Alimentazione

Alimentation



**ama**

**Ricambi & accessori per macchine agricole**

**SPARE PARTS & ACCESSORIES FOR AGRICULTURAL MACHINE**

Tutti gli articoli della presente sezione, prodotti da AMA SPA e/o da terzi per conto di AMA, sono adattabili ("non originali") alle marche indicate ai sensi di quanto previsto dal REG. CE n. 1400/2002. I diritti sui marchi citati appartengono ai legittimi proprietari e il loro uso ha l'esclusiva finalità di consentire all'utilizzatore la comparazione dei diversi prodotti. All items of this section, manufactured by AMA SPA and/or any third party on behalf of AMA, are adaptable ("non-original") to the brands listed under the provisions of the REG. CE n. 1400/2002. The rights on the trademarks belong to their respective owners and their usage is only aimed to allow the user to compare different products.

**CORPO DISTRIBUTORE LEVA CORTA SINISTRA**

DISTRIBUTEUR LEVIER COURT, GAUCHE  
 SHORT LEFT LEVER DISTRIBUTOR  
 KURZE, LINKE HEBEL STEUERGERÄT  
 CUERPO DISTRIBUIDORE PALANCA CORTA IZQUIERDA



**Note:** Per prese a pressione supplementari del sollevatore adattabili a trattori FIAT "SERIE ORO".

**Notes:** Additional valve suitable FIAT tractor "SERIE ORO".

Art./Ref.	Note/Note	Brand	Applicazione/Application	Rif. Orig./Orig. Ref.
04281	Leva corta sinistra/Short left lever	FIAT	300, 400, 420, 450, 460, 480, 500, 540, 550, 605, 640	588771

**LEVA LUNGA DESTRA**

LEVIER LONG DROITE  
 LONG RIGHT LEVER  
 LANGE RECHTE HEBEL  
 PALANCA LARGA DERECHA



Art./Ref.	Note/Note	Brand
04867	Kit Ricambio leva lunga dx/Replacement long right lever	FIAT

**PROLUNGA DE - SE PER DISTRIBUTORI LEVA LUNGA E CORTA**

BOUCHON DE - SE POUR DISTRIBUTEUR  
 DE - SE EXTENSION FOR LONG AND SHORT LEVER DISTRIBUTORS  
 DE - SE STÖPSEL  
 PROLONGADOR PARA DISTRIBUIDORES PALANCA LARGA E CORTA



Art./Ref.	Note/Note	Brand
04866	Per distributori leva lunga e corta./For long and short lever distributors	FIAT

**RICAMBIO MOLLA PER DISTRIBUTORI LEVA LUNGA E CORTA**

RESSORT DE RECHANGE POUR DISTRIBUTEUR  
 REPLACEMENT SPRING FOR LONG AND SHORT LEVER DISTRIBUTORS  
 ERSATZFEDER STEUERGERÄT KURZEN - LANGE HEBEL  
 RECAMBIO MUELLE



Art./Ref.	Note/Note	Brand	Rif. Orig./Orig. Ref.
04865	Molla per distributori leva lunga e corta adattabile/for long and short lever distributors	FIAT	588779

**KIT COMPLETO PER L'APPLICAZIONE DEI DISTRIBUTORI ADATTABILE PER TRATTORI FIAT ""SERIE ORO"" LEVA SIN. E LEVA DX.**

KIT POUR L'APPLICATION DES DISTRIBUTEURS ADAPTABLE FIAT JUSQU'AU 640, LEVIERS DR. OU G.  
 HYDRAULIC COMPLETE SET FOR DISTRIBUTORS ADAPTABLE FIAT TRACTORS UP TO 640'S  
 KPL. HYDRAULIKSATZ MIT STEUERGERÄT PASSEND ZU FIAT SCHLEPPER BIS SERIE 640  
 KIT PARA APLICACIÓN DEL DISTRIBUIDOR ADAPTABLE TRACTORES ""FIAT""

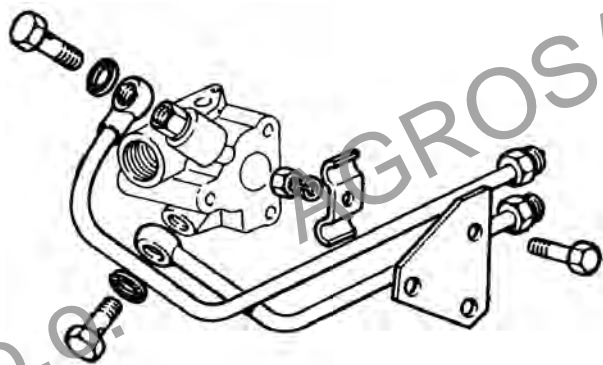

Art./Ref.	Note/Note	Brand
04280	Adattabile a trattori FIAT "Serie Oro" leva sx e leva dx /Adaptable to FIAT "Gold Series", left and right lever	FIAT

**CORPO DISTRIBUTORE KONTAK 1° ELEMENTO**

DISTRIBUTEUR KONTAK 1ER ELEMENT  
 1ST ELEMENT FOR KONTAK DISTRIBUTOR  
 1 ELEMENT KONTAK STEUERGERÄT  
 DISTRIBUIDOR KONTAK 1° ELEMENTO



**Note:** Per presa a pressione supplementare del sollevatore adattabile a trattori FIAT.  
**Notes:** Additional valve suitable for FIAT tractors.

Art./Ref.	Note/Note	Brand	Applicazione/Application	Rif. Orig./Orig. Ref.
04285	Corpo distributore, 1° elemento/First element for distributor.	FIAT	1000, 850	5112583

**SECONDO E TERZO ELEMENTO AGGIUNTIVO KONTAK ADATTABILE**

DEUXIEME ET TROISIEME ELEMENT KONTAK ADAPTABLE  
 SECOND AND THIRD KONTAK ELEMENTS SUITABLE  
 2 UND 3 ELEMENT KONTAK - STEUERGERÄT PASSEND ZU  
 DISTRIBUIDOR KONTAK 2° Y 3° ELEMENTO COMPATIBLE



Art./Ref.	Note/Note	Brand	Applicazione/Application	Rif. Orig./Orig. Ref.
<b>04290</b>	Doppio effetto/Double effect		55.65 F, 55.65 M, 55.65 V, 55.66, 55.66 DT, 55.66 DTLP, 60.65, 60.65 M, 60.65 V, 60.66, 60.66 DT, 65.66, 65.66 DT, 70.65, 70.65 DT, 70.66, 80.65, 80.66, 80.66 DT, 85.55, 95.55	5116876, 5146658
<b>08652</b>	Doppio effetto flottante/Flotating double effect	<b>FIAT</b>	100.55, 100.90-100.90DT, 110.90-110.90DT, 45.66-45.66DT, 45.66S-45.66S DT, 50.66-50.66DT, 50.66S-50.66S DT, 55.56-55.56DT, 55.65F-55.65M-55.65V-55.65 DT, 55.66S-55.66S DT, 55.66S-55.66S DT, 55.75F-55.75M-55.75V, 55.85F-55.85M-55.85V, 55.90-55.90DT, 60.56 DT, 60.65-60.65M, 60.66-60.66 DT-60.66S, 60.75-60.75M-60.75V, 60.76F DT, 60.85F-60.85V, 60.88-60.88 DT, 60.90-60.90 DT, 60.93, 60.94-60.94 DT, 62.85-62.85M, 62.86F-62.86F DT, 65.56-65.56 DT, 65.66-65.66 DT, 65.66S DT, 65.88-65.88 DT, 65.90-65.90 DT, 65.93-65.93 DT, 65.94-65.94 DT, 70.56-70.56 DT, 70.65M, 70.66-70.66V-70.66S, 70.75-70.75M, 70.76F DT, 70.88-70.88 DT, 70.90-70.90 DT, 72.85-72.85M, 72.86F DT, 72.93 DT, 72.94 DT, 80.65, 80.66-80.66 DT, 80.66S-80.66S DT, 80.75, 80.76F-80.76F DT, 80.88-80.88 DT, 80.90-80.90 DT, 82.86 DT, 82.93 DT, 82.94-82.94 DT, 85.55, 85.90 DT, 88.93-88.93 DT, 88.94-88.94 DT, 90.90-90.90 DT, 95.55, F100-F100 DT, F110-F110 DT, F115 DT, F120 DT, F130 DT, F140-F140 DT	5118355, 5136348, 5154669
<b>08652</b>	Doppio effetto flottante/Flotating double effect	<b>FORD</b>	3435 2WD, 3935 2WD, 4030 2WD, 4135 2WD, 4230 2WD, 4430 2WD, 4635, 4835, 5635, 6635, 7635, 8160, 8260	5118355, 5136348, 5154669
<b>08652</b>	Doppio effetto flottante/Flotating double effect	<b>NEW HOLLAND</b>	L60-L65-L75-L85-L95, M100-M115-M135, TK65F-TK75F, TK75M-TK75V, TK76-TK76M, TK85-TK85M, TK95M, TL70-TL80-TL90-TL100, TM115-TM120-TM125-TM130-TM140, TN55-TN55D-TN55S-TN55V, TN65-TN65D-TN65F-TN65N-TN65S, TN65V, TN70-TN70D-TN70F-TN70S, TN75-TN75D-TN75F-TN75N-TN75S, TN75V, TN80F, TN90F, TN95F	5118355, 5136348, 5154669

**INNESTO RAPIDO ORIGINALE FASTER ADATTABILE GRUPPO SDF**

CONNEXION RAPIDE FEMELE D'ORIGINE FASTER PUSH-PULL ADAPTABLE FIAT

QUICK CONNECTION FASTER ORIGINAL SUITABLE SDF BRAND

KUPPLUNG WEIBLICH, UNTER DRUCK KUPPELBAR, ORIGINAL FASTER

CONEXIÓN RAPIDA ORIGINAL FASTER HEMBRA DE VAIVÉN

**Faster**

**Note:** Connessione spingendo la parte maschio.  
 Disconnessione tirando la parte maschio.  
 Innestabile con maschio (ISO A) in pressione.  
 Disconnessione in pressione solo come manovra di emergenza.  
 Intercambiabilita' secondo norme ISO 7241-1 parte A.

**Notes:** Connection by pushing the male coupling.  
 Disconnection by pulling the male part.  
 Connectable with male part (ISO A) under pressure.  
 Disconnection under pressure only as breakaway.  
 Interchangeability according to ISO 7241-1 part A.

Art./Ref.	Descrizione/Description	Note/Note	Brand	Applicazione/Application	Rif. Orig./Orig. Ref.	
17091	Innesto rapido originale Faster femmina push-pull 1/2" - 1/2" BSP/ Original "Faster" female 1/2" - 1/2" BSP push-pull quick coupling	Faster ref. 3CFPV 12 GAS F	LAMBORGHINI - DEUTZ - HURLI- MANN - SAME	VARI MODELLI, VARI MODELLI, VARI MODELLI	-	
			FIAT	100.90-100.90 DT, 110.90-110.90 DT, 55.88-55.88 DT, 55.90-55.90 DT, 60.88-60.88 DT, 60.90-60.90 DT, 60.93-60.93 DT, 60.94-60.94 DT, 65.88, 65.90 DT, 65.93-65.93 DT, 65.94-65.94 DT, 70.76F DT, 70.76LP-70.76LP DT, 70.88-70.88 DT, 80.90-80.90 DT, F100 DT, F110-F110 DT, F115-F115 DT, F120-F120 DT, F130-F130 DT, F140-F140 DT	5152185, 5152194	
			FORD	5635-6635-4635-4835	-	
			NEW HOLLAND	L60-L65-L75-L85-L95, M100-M115-M135-M160, T5030-T5040-T5050-T5060-T5070, TK4020F-TK4020V, TK4030-TK4030F-TK4030V, TK4040-TK4040M, TK4050-TK4050M, TK4060	5152194	
75949	Innesto rapido originale Faster femmina push-pull M22x1,5/ Original "Faster" quick female push-pull coupling M22x1.5	Faster ref. 3CFPV 1/2215F	AGRITALIA	VARI MODELLI	-	
			NEW HOLLAND - CASE	VARI MODELLI, VARI MODELLI	-	
			CHALLENGER	MT425B-MT445B-MT455B, MT465B-MT475B, MT545B	3794298M2	
			JOHN DEERE	VARI MODELLI	-	
			LANDINI	VARI MODELLI	-	
			MASSEY FERGUSON	240-243-253-263-275-290, 2655-2855, 375-390, 410-420-430, 4215-4220, 4225-4235-4240, 4245-4255-4265, 4260-4270, 4265-4365, 4315-4320, 4325-4335, 4345-4355, 4360-4370, 6235-6245-6255, 6260-6265-6270-6280-6290, LT75A-LT85A-LT90A-LT95A, SERIE 5400, SERIE 6400, SERIE 7400	3794298M1, 3794298M2	
RENAULT	VARI MODELLI	-				
84442	Innesto rapido originale Faster femmina push-pull 1/2" - 1/2" NPT/Original "Faster" female push-pull 1/2" - 1/2" NPT quick coupling	Faster ref. 3CFPV 12 NPT F	NEW HOLLAND	VARI MODELLI	-	
84443	Innesto rapido originale Faster femmina push-pull 1/2" - 3/4" NPT/Original "Faster" female push-pull 1/2" - 3/4" NPT quick coupling	Faster ref. 3CFPV 34 UNF F	LANDINI	VARI MODELLI	-	

**FILTRO COMPLETO TIPO CAV CON SUPPORTO ADATTABILE**

COMPLETE FILTER TYPE CAV WITH SUPPORT  
 COMPLETE FILTER TYPE CAV WITH SUPPORT ADAPTABLE  
 CAV FILTER KPLT. MIT ANSCHLUSSPLATTE PASSEND ZU  
 FILTROS COMPLETOS TIPO "CAV" ADAPTABLE



Pos.1



Pos.2

Art./Ref.	Pos.	Tipo/Type	Filettatura/Thread	Brand	Applicazione/Application	Rif. Orig./Orig. Ref.
<b>06271</b>	1	Singolo/Single	1/2" UNF.	<b>FENDT</b>	VARI MODELLI	-
<b>11084</b>	2	Doppio/Double	1/2" UNF.			-
<b>06270</b>	1	Singolo/Single	Metrico M 14 x 1,5	<b>FIAT</b>	300-340-350, 500-550-640, 55.65 - 60.65, 55.66 - 60.66, 55.90 - 60.90 65.46, 65.66 - 70.66 - 80.66, 65.88 - 70.88 - 80.88, 70.65 - 80.65, 70.76 - 80.76, 1020-1120-2020-2120-3120, 1830-2030-2130	4612229, 4616707, 4776811, 9927913
<b>11085</b>	2	Doppio/Double				4659288
<b>06271</b>	1	Singolo/Single	1/2" UNF.	<b>FORD</b>	VARI MODELLI	-
<b>11084</b>	2	Doppio/Double				83929882, EBPN-9N166AA
<b>11084</b>	2	Doppio/Double	1/2" UNF.	<b>JOHN DEERE</b>	VARI MODELLI 1020-1120-2020-2120-3120, 1830-2030-2130	-
<b>11085</b>	2	Doppio/Double	Metrico M 14 x 1,5			AR66294, RE506253
<b>06271</b>	1	Singolo/Single	1/2" UNF.	<b>LANDINI</b>	VARI MODELLI	883786M91
<b>11084</b>	2	Doppio/Double				1446891M91, 894976M91
<b>06271</b>	1	Singolo/Single	1/2" UNF.	<b>MASSEY FERGUSON</b>	VARI MODELLI	883786M91
<b>11084</b>	2	Doppio/Double				1446891M91, 894976M91
<b>06271</b>	1	Singolo/Single	1/2" UNF.	<b>PERKINS</b>	VARI MODELLI	2656615
<b>11084</b>	2	Doppio/Double				2656804, 2656811

**RICAMBI PER FILTRI COMPLETI ADATTABILI**

RECHANGES POUR FILTRE TYPE ADAPTABLE

PARTS FOR COMPLETE FILTERS ADAPTABLE

ERSATZTEILE FILTER PASSEND ZU

RECAMBIOS PARA FILTROS COMPLETOS ADAPTABLE

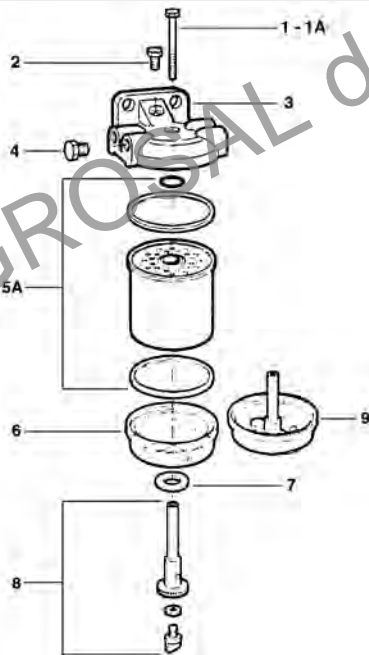

Art./Ref.	Pos.	Note/Note	Brand	Applicazione/Application	Rif. Orig./Orig. Ref.
02731	5	Tipo CAV 296 basso - rif. orig. CAV 7111-296/ Type CAV 296 short - orig. ref. CAV 7111-296	FENDT	108LSA, 108S, 200S, 201S, 203V, 204P, 205P, 240S, 250SA, 250VA, 275VA, 280PA	F278201060040
06272	3	Supporto per una vasca passo decimale - rif. orig. CAV 7111-353BV/ Support for decimal plug - orig. ref. CAV 7111-353BV		-	9918117, 9927918
06273	3	Supporto per una vasca passo pollice - rif. orig. CAV 7111-353AS/ Support for inch pluch - orig. ref. CAV 7111-353AS		-	9927916
02731	5	Tipo CAV 296 basso - rif. orig. CAV 7111-296/ Type CAV 296 short - orig. ref. CAV 7111-296	FIAT	3300 MIETITREBBIA LAVERDA, 3300AL MIETITREBBIA LAVERDA, 3300R MIETITREBBIA LAVERDA, 3400 MIETITREBBIA LAVERDA, 3400R MIETITREBBIA LAVERDA, 3500 MIETITREBBIA LAVERDA, 3500AL MIETITREBBIA LAVERDA, 3500R MIETITREBBIA LAVERDA, 3550 MIETITREBBIA LAVERDA, 3550R MIETITREBBIA LAVERDA, 355C, 3650 MIETITREBBIA LAVERDA, 3650R MIETITREBBIA LAVERDA, 3750 MIETITREBBIA LAVERDA, 3750R MIETITREBBIA LAVERDA, 455C, 465C, 465C/V/F, 505C, 555C, 565C, 605C, 765C, 805C, 80C, 855C, 90C, L517 MIETITREBBIA LAVERDA, SERIE 55 85.55.00, SERIE 65 80.65C, SERIE 65 60.65C, SERIE 65 70.65C, SERIE 66 65.66, SERIE 66 80.66, SERIE 66 80.66/F, SERIE 66 55.66, SERIE 66 60.66, SERIE 66 70.66, SERIE 66 70.66/LP-F, SERIE 66 55.66/LP, SERIE 75 70.75C, SERIE 75 80.75C, SERIE 76 70.76/LP-VF, SERIE 76 80.76/F, SERIE 85 88.85C, SERIE 85 72.85C, SERIE 85 82.85C, SERIE 88 70.88, SERIE 88 80.88, SERIE 90 115.90, SERIE 90 70.90, SERIE 90 85.90, SERIE 90 140.90, SERIE 90 55.90, SERIE 90 60.90, SERIE 90 65.90, SERIE 90 130.90, SERIE 90 80.90, SERIE 93 72.93, SERIE 93 88.93, SERIE 93 65.93, SERIE 93 82.93, SERIE 94 82.94, SERIE 94 88.94, SERIE 94 65.94, SERIE 94 72.94	1901687, 1909100, 4621740, 4651986, 4669551, 4669556, 4680444, 4787696, 70251397, 84535312, 9918114, 9924318
02742	5	Tipo Cav Lungo - rif. orig. CAV 7111-796/ Long cav type, - orig. ref. CAV 7111-796		555C - 655C TERNA GOMMATA, 555D - 575D - 655D TERNA GOMMA	1930277
02721	6	Vasca Decantatore Vetro - rif. orig. CAV 7111-429/ Glass Fuel Filter Bowl - orig. ref. CAV 7111-429		-	9918123
06275	6	Vasca decantatore in alluminio - rif. orig. CAV 7111-493/ Aluminum fuel fil er bowl - orig. ref. CAV 7111-493		-	9918123
08471	7	Gommino grande perno centrale/Large rubber center pin		-	9918124

Art./Ref.	Pos.	Note/Note	Brand	Applicazione/Application	Rif. Orig./Orig. Ref.
06273	3	Supporto per una vasca passo pollice - rif. orig. CAV 7111-353AS/Support for inch pluch - orig. ref. CAV 7111-353AS			83919133
02731	5	Tipo CAV 296 basso - rif. orig. CAV 7111-296/ Type CAV 296 short - orig. ref. CAV 7111-296	FORD	2000 BSD 326, 2310 BSD 326, 2600 BSD 326, 2610>01.81 BSD 329, 2610>01.82 BSD 329, 2810 BSD 326, 2910 BSD 329, 3000 BSD 329, 3055 BSD 331, 3230 BSD 332, 3430 BSD 332, 3435 8035.06, 3600 BSD 329, 3610>01.81 BSD 332, 3610>01.82 BSD 332, 3900 BSD 332, 3910 BSD 332, 3910 H BSD 332, 3930 BSD 333, 3930 H BSD 332, 3935 8035.06, 4000 BSD 333, 4100 BSD 331, 4110>01.81 BSD 333H, 4110>01.82 BSD 333H, 4130 BSD 333, 4130 H BSD 333, 4135 8035.06, 4330 BSD 333, 4600 BSD 333H, 4610 H BSD 333, 4610>01.81 BSD 333H, 4610>01.82 BSD 333H, 4630 BSD 333H, 4635 L60 8035.05, 4830 BSD 442, 4835 L65 8045.06, 5000 4/68< BSD 442, 5000 <3/68 BSD 348, 5030 BSD 442, 5110 BSD 444, 550 BSD 333H, 555 BSD 333H, 555 A BSD 333, 555 B BSD 333, 555 C BSD 444, 5600 10/80< BSD 444, 5600<09/80 BSD 442, 5610 BSD 444, 5635 L75 8045.06, 5640 P.S. 4.4, 5700 10/80< BSD 444, 5700<09/80 BSD 442, 5900 BSD 444, 6410 BSD 444, 655 BSD 444, 655 A BSD 444, 655 C BSD 444, 655 D BSD 444, 6600 10.80> BSD 444, 6600>09.80 BSD 444, 6610 BSD 444, 6635 L85 8045.25, 6640 P.S. 5.0, 6700 BSD 444, 6710>09.80 BSD 444, 6710>10.80 BSD 444, 6810 BSD 444TS, 7000 BSD 444T, 7410 BSD 444T, 7600 BSD 444TS, 7610 BSD 444TS, 7635 L95 8045.25, 7700 BSD 444TS, 7710 BSD 444TS, 7740 P.S. 5.0T, 7810 BSD 666, 7840 P.S. 6.6, 7910 BSD 666, 8000 BSD 666, 8100 BSD 380, 8160 M100 P.S. 7.5, 8200 BSD 666, 8210 BSD 666, 8240 P.S. 7.5, 8260 M115 P.S. 7.5, 8340 9/93< P.S. 7.5T, 8340<8/93 P.S. 7.5, 8360 M135 P.S. 7.5T, 8401 BSD 666, 8530 BSD 666, 8560 M160 P.S. 7.5TI, 8600 BSD 666, 8630 BSD 666T, 8670 G170 P.S. 7.5T, 8700 BSD 666, 8730 BSD 666T, 8770 G190 P.S. 7.5T, 8830 BSD 666TI, 8870 G210 P.S. 7.5TI, 8970 G240 P.S. 7.5TI, 9000 BSD 666T, 9200 BSD 666T, 9600 BSD 666T, 9700 BSD 666T, TW 10, TW 15, TW 20, TW 25, TW 30, TW 35, TW 5	83937061, 84535312
02742	5	Tipo Cav Lungo - rif. orig. CAV 7111-796/ Long cav type - orig. ref. CAV 7111-796		3230 - 3430, 3930, 3930H - 3930N - 3930NO, 4130 - 4130N - 4130NO, 4630 - 4630N - 4630NO, 4830 - 4830N - 4830NO, 5030 - 5030N, 5110 - 5610, 6410 - 6610 - 6710 - 6810, 66100 - 76100, 7410 - 7610 - 7710, TW10 - TW20 - TW30	1930277, 83917626, 86570171
06277	9	Vasca decantatore in alluminio con perno - rif. orig. CAV 7111-542A/ Aluminum fuel filter bowl with pin - orig. ref. CAV 7111-542A		-	83913800
02731	5	Tipo CAV 296 basso - rif. orig. CAV 7111-296/ Type CAV 296 short - orig. ref. CAV 7111-296	JOHN DEERE	1020, 1030, 1120, 1130, 1630, 2020, 2030, 3020, 3130, 4020, 820, 830, 920, 930	AT17387
02731	5	Tipo CAV 296 basso - rif. orig. CAV 7111-296/ Type CAV 296 short - orig. ref. CAV 7111-296	KUBOTA	15451-43560	-



Art./Ref.	Pos.	Note/Note	Brand	Applicazione/Application	Rif. Orig./Orig. Ref.
02731	5	Tipo CAV 296 basso - rif. orig. CAV 7111-296/ Type CAV 296 short - orig. ref. CAV 7111-296	LANDINI	ADVANTAGE CABINATO: 55F, ADVANTAGE CABINATO: 55GT, ADVANTAGE CABINATO: 55L, ADVANTAGE CABINATO: 60F, ADVANTAGE CABINATO: 60GT, ADVANTAGE CABINATO: 60L, ADVANTAGE CABINATO: 65F, ADVANTAGE CABINATO: 65GT, ADVANTAGE CABINATO: 65L, ADVANTAGE CABINATO: 75F, ADVANTAGE CABINATO: 75GT, ADVANTAGE CABINATO: 75L, ADVANTAGE CABINATO: 85F, ADVANTAGE CABINATO: 85GT, ADVANTAGE CABINATO: 85L, ADVANTAGE CABINATO: L95GT, ADVANTAGE F.S.: 55FP/LP/GT, ADVANTAGE F.S.: 60FP/LP/GT, ADVANTAGE F.S.: 65FP/LP/GT, ADVANTAGE F.S.: 75FP/LP/GT, ADVANTAGE F.S.: 85FP/LP/GT, ATLAS: 100, ATLAS: 70, ATLAS: 75, ATLAS: 80, ATLAS: 85, ATLAS: 90, BLIZZARD: 50, BLIZZARD: 60, BLIZZARD: 65, BLIZZARD: 75, BLIZZARD: 85, BLIZZARD: 95, CINGOLATI C: C4500, CINGOLATI C: C4830, CINGOLATI C: C5500, CINGOLATI C: C5830, CINGOLATI C: C6500, CINGOLATI C: C6830, CINGOLATI C: C7800, CINGOLATI C: C7830, CINGOLATI C: C8860, CINGOLATI C: C5000, CINGOLATI C: C6000, CINGOLATI C: CF4830, CINGOLATI C: CF6030, CINGOLATI C: CF5830, CINGOLATI C: CF6030, CINGOLATI C: CF6060, CINGOLATI C: CF6830, FRUTTETI 530 F/L/V: 4530V, FRUTTETI 530 F/L/V: 5530 F/L/V, FRUTTETI 530 F/L/V: 6030 F/L/V, FRUTTETI 530 F/L/V: 6530 F/L/V, FRUTTETI 530 F/L/V: 7530 F/L/V, FRUTTETI 560 F/L/V: 4560V, FRUTTETI 560 F/L/V: 5560 F/L/V, FRUTTETI 560 F/L/V: 6060 F/L/V, FRUTTETI 560 F/L/V: 6560 F/L/V, FRUTTETI 560 F/L/V: 7560 F/L/V, FRUTTETI 560 F/L/V: 8560 F/L/V, GHIBLI: 100, GHIBLI: 90, GHIBLI: 80, GLOBUS: 55, GLOBUS: 60, GLOBUS: 65, GLOBUS: 70, LARGE: 10000, LARGE: 10000S, LARGE: 12500, LARGE: 13000, LARGE: 14500, LEGEND N/G: 115, LEGEND N/G: 120, LEGEND N/G: 130, LEGEND N/G: 140, LEGEND N/G: 160, LEGEND N/G: 180, LEGEND: 105, LEGEND: 115, LEGEND: 130, LEGEND: 145, LEGEND: 165, MYTHOS: 110, PRIMI MODELLI 5000R-DT-S-N, PRIMI MODELLI 6000R-DT-S, PRIMI MODELLI 7000 SPECIAL, PRIMI MODELLI 7000R-DT, PRIMI MODELLI 8000R-DT-S, REX CABINATI: 100, REX CABINATI: 60, REX CABINATI: 70, REX CABINATI: 80, REX CABINATI: 90, REX FOOT STEP: 100FP-LP-GTP-GE, REX FOOT STEP: 60FP-LP-GE, REX FOOT STEP: 70FP-LP-GTP-GE, REX FOOT STEP: 80FP-LP-GTP-GE, REX FOOT STEP: 90FP-LP-GTP-GE, SERIE 30: 5830, SERIE 30: 6030, SERIE 30: 6830, SERIE 30: 7830, SERIE 30: 8830, SERIE 40: 5840, SERIE 40: 6040, SERIE 40: 6840, SERIE 500: 5500, SERIE 500: 6500, SERIE 500: 7500, SERIE 500: 8500, SERIE 500: 9500R-DT, SERIE 50: 6550, SERIE 50: 7550, SERIE 50: 8550, SERIE 60 NEW: 5860, SERIE 60 NEW: 6860, SERIE 60 NEW: 7860, SERIE 60 NEW: 8860, SERIE 60: 5860, SERIE 60: 6060, SERIE 60: 6860, SERIE 60: 7860-7860HC, SERIE 60: 8860-8860HC, SERIE 60: 9060, SERIE 70: 5870, SERIE 70: 6070, SERIE 70: 6870, SERIE 70: 7870, SERIE 70: 8870, SERIE 80: 6880, SERIE 80: 7880, SERIE 80: 8880-8880HC, SERIE 80: 9080-9080HC, SERIE 80: 9880-9880HC, TREKKER NEW 100C, TREKKER NEW 70 C/F/L, TREKKER NEW 80 C/F/L, TREKKER NEW 90 C/F/L, TREKKER: C75, TREKKER: C85, TREKKER: C95, TREKKER: CF55, TREKKER: CF60, TREKKER: CF65, TREKKER: CF70, TREKKER: CF75, TREKKER: CF85, VIGNETI CABINA V.Q: 55V, VIGNETI CABINA V.Q: 60V, VIGNETI CABINA V.Q: 65V, VIGNETI CABINA V.Q: 75V, VIGNETI F.S: 55V, VIGNETI F.S: 60V, VIGNETI F.S: 65V, VIGNETI FOOT STEP: 75V, VIGNETI REX CAB: 60V, VIGNETI REX CAB: 65V, VIGNETI REX CAB: 70V, VIGNETI REX CAB: 80V, VISION: 100, VISION: 80, VISION: 90	E3541160M1
02742	5	Tipo Cav Lungo - rif. orig. CAV 7111-796/ Long cav type - orig. ref. CAV 7111-796		CINGOLATI: C10500, LARGE: 16000, LARGE: 16500	1896287M91 E3541382M1
02731	5	Tipo CAV 296 basso - rif. orig. CAV 7111-296/ Type CAV 296 short - orig. ref. CAV 7111-296	LOMBARDINI	673, 825, LDA 670, SLD675	2175.042

Art./Ref.	Pos.	Note/Note	Brand	Applicazione/Application	Rif. Orig./Orig. Ref.
<b>02731</b>	5	Tipo CAV 296 basso - rif. orig. CAV 7111-296/ Type CAV 296 short - orig. ref. CAV 7111-296	<b>MASSEY FERGUSON</b>	1080 A4.318, 1100 A6.354.1, 1105 A6.354.4, 1135 A6.354.4, 1200 A6.354.1, 1250 A6.354.4, 135 AD3.152, 148 AD3.152, 155 AD4.203, 158 AD4.203, 165 A4.212, 165 AD4.203, 168 A4.236, 175 A4.236, 178 A4.248, 185 A4.248, 230 AD3.152, 235 AD3.152, 240 AD3.152, 250 AD3.152, 255 AD3.152, 260 AD4.203, 2620 A6.354.4, 2625 A6.354.4, 2640 A6.354.4, 2645 A6.354.4, 265 A4.236, 2680 AT6.354.4, 2685 AT6.354.4, 2720 AT6.354.4, 2725 AT6.354.4, 275 A4.236, 285 A4.248, 285 A4.318, 290 A4.248, 294 A4.248, 296, 298 A4.318, 3050 A4.236, 3060 A4.248, 3065 A4.236, 3070 A4.236, 3075 1004.4, 3075 A4.236, 3080 A6.354.4, 3085 1006.6, 3090 A6.354.4, 3095 1006.6, 3115 1006.6, 3120 1006.6T, 3120T 1006.6T, 3125 1006.6T, 3140 1006.6T, 340 AD3.152, 342 AD3.152, 35 A3.152, 350 AD3.152, 352 AT3.152, 355 AT3.152, 360 AT3.152, 3610 A6.354.4, 362 A4.236, 3630 AT6.534.4, 3635 1006.6T, 3645 1006.6T, 3645 AT6.354.4, 365 A4.236, 3650 AT6.354.4, 3655 1006.6T, 3660 1006.6T, 372 A4.236, 375 A4.236, 382 A4.248, 390 A4.248, 390T A4.236, 398 A4.236, 399 1006.6, 399 A6.354.4, 4225 1004.4, 4225 4.41, 4235 1004.4, 4235 4.41, 4245 1004.4T, 4255 1004.4T, 4255 4.41, 4260 1006.6, 4270 1006.6, 550 AD3.152, 560 AD4.203, 565 A4.236, 575 A4.236, 590 A4.248, 595 A4.318, 6110 4.41, 6120 4.41, 6130 1004.4T, 6140 1004.4T, 6150 1004.4T, 6160 1006.6, 6160 1006.6T, 6170 1006.6, 6170 1006.6T, 6180 1006.6T, 6190 1006.6T, 65 A4.203, 65 AD4.203, 675 A4.236, 690 A4.248, 698 A4.318, 698T A4.236, 699 A6.354.4, 765 AD4.203, 8110 1006.6T, 8120 1006.6T <F, 8120 1006.6T FO, 8130 1006.6T	1049939M91, 151890M1, 1640997M91, 1802271M1, 1841890M1, 1951890M1, 2871492M1, 3405418M1, 835994M92, 836218M91, 851890M1
<b>02742</b>	5	Tipo Cav Lungo - rif. orig. CAV 7111-796/ Long cav type orig. ref. CAV 7111-796		1080 A4.318, 1100 A6.354.1, 1105 A6.354.4, 1135 A6.354.4, 1200 A6.354.1, 1250 A6.354.4, 135 AD3.152, 148 AD3.152, 155 AD4.203, 158 AD4.203, 165 A4.212, 165 AD4.203, 168 A4.236, 175 A4.236, 178 A4.248, 185 A4.248, 230 AD3.152, 235 AD3.152, 240 AD3.152, 250 AD3.152, 255 AD3.152, 260 AD4.203, 2620 A6.354.4, 2625 A6.354.4, 2640 A6.354.4, 2645 A6.354.4, 265 A4.236, 2680 AT6.354.4, 2685 AT6.354.4, 2720 AT6.354.4, 2725 AT6.354.4, 275 A4.236, 285 A4.248, 285 A4.318, 290 A4.248, 294 A4.248, 298 A4.318, 3050 A4.236, 3060 A4.248, 3065 A4.236, 3070 A4.236, 3080 A6.354.4, 3090 A6.354.4, 340 AD3.152, 342 AD3.152, 350 AD3.152, 352 AT3.152, 355 AT3.152, 360 AT3.152, 3610 A6.354.4, 362 A4.236, 3630 AT6.534.4, 3645 AT6.354.4, 365 A4.236, 3650 AT6.354.4, 372 A4.236, 375 A4.236, 382 A4.248, 390 A4.248, 390T A4.236, 398 A4.236, 550 AD3.152, 560 AD4.203, 565 A4.236, 575 A4.236, 590 A4.248, 595 A4.318, 6110 4.41, 6120 4.41, 6130 1004.4T, 6140 1004.4T, 6150 1004.4T, 6160 1006.6, 6160 1006.6T, 6170 1006.6, 6170 1006.6T, 6180 1006.6T, 6190 1006.6T, 65 A4.203, 65 AD4.203, 675 A4.236, 690 A4.248, 698 A4.318, 698T A4.236, 699 A6.354.4, 765 AD4.203, 796, 8120 1006.6T FO	1896287M1, 3405419M1
<b>02721</b>	6	Vasca Decantatore Vetro - rif. orig. CAV 7111-429/ Glass Fuel Filter Bowl - orig. ref. CAV 7111-429		-	1039071M1
<b>02731</b>	5	Tipo CAV 296 basso - rif. orig. CAV 7111-296/ Type CAV 296 short - orig. ref. CAV 7111-296	<b>NEW HOLLAND</b>	L454 MINI PALE, L455 MINI PALE, L553 MINI PALE, L555 MINI PALE, L778 MINI PALE, L779 MINI PALE, L781 MINI PALE, L783 MINI PALE, L785 MINI PALE, L865 MINI PALE, LX865, LX885, SB33 BRAUD VENDEMMIATRICI, SB52 BRAUD VENDEMMIATRICI, SB53 BRAUD VENDEMMIATRICI, SB54 BRAUD VENDEMMIATRICI, SB56 BRAUD VENDEMMIATRICI, SB58 BRAUD VENDEMMIATRICI, TS 100, TS 110, TS 115, TS 80, TS 90	1909100, 84535312

Art./Ref.	Pos.	Note/Note	Brand	Applicazione/Application	Rif. Orig./Orig. Ref.
02731	5	Tipo CAV 296 basso - rif. orig. CAV 7111-296/ Type CAV 296 short - orig. ref. CAV 7111-296	PERKINS	1004.40, 1004.40T, 1004.42, 3.152.2, 3.152.4, 4.108, 4.236, 403D-11, 403D-15, 404D-22, 6.354.4, D3.152, T4.236, T6.354.4	26560017, 26561117
02742	5	Tipo Cav Lungo - rif. orig. CAV 7111-796/ Long cav type - orig. ref. CAV 7111-796		6.354 - T6.354, 6.354.4 - T6.354.4, V8.540 - TV8.540	26560602, 26566602
02721	6	Vasca Decantatore Vetro - rif. orig. CAV 7111-429/ Glass Fuel Filter Bowl - orig. ref. CAV 7111-429		-	26560111, 26560601
06275	6	Vasca decantatore in alluminio - rif. orig. CAV 7111-493/ Aluminum fuel filter bowl - orig. ref. CAV 7111-493		-	26560111

02731	5	Tipo CAV 296 basso - rif. orig. CAV 7111-296/ Type CAV 296 short - orig. ref. CAV 7111-296	RENAULT	103.12RS/TS/TX, 103.14RS/TX, 103.54TM/TX, 106-14SP, 110-14RE/TA/TE/TS/TX, 106.14RS/TX, 106.54TL, 110.54T, 106.54 MWM, 110-54TA/TE/TS/TX/TZ, 120-54TA, 113.14TX, 133.14TS/TX, 145.14T, 1151 1151-4, 1181 1181-4, 1451- 4 (R7694), 155.54TZ, 155.54TX/TZ/Nectra,, 301, 351M, 32-5032-60, 321-4, 451-4, 571-4, 42-70F/V, 44-70F/V, 421 M, 421M, 456 M, 460 M, 461, 461M/Spezial, 462 M, 466S, 480S/V, 486 M, 489 M, 490 (R7398-4-L), 496 M, 498 M, 50 (7211) MWN 325-2, 50 S/SV MWN D327-2, 50.12LB, 55.12LB, 58.32MX, 58., 501-4, 601-4, 51 (7256) 56 (7251), 53 (7213) MWN 325-2, 55 (7231) 57 (7241), 551 551-4, 551-43, 556 556S, 58-12LS, 58-14LS, 61-12RA/RS,, 58- 32MA/ME/MS/MX, 58-34MA/ME/M, 60 (7253) 61 (7254), 600M, 600MI, 60S MWN 325-3, 61.12RS, 61.14S/RS MWN 325-3, 65.12LS, 65.32MX, 65.34MX D22, 651, 651-4, 652, 656, 656S, 68, 68-12RA/RS, 68-14RA/RS, 75-12L, 68.12RS 68.14RS, 70 MWM D305-3R, 70 (7252) MWM, 70-12SP, 70- 14SP, 70-32PA/PE/PS/PX, 70-34PA/PE/P, 70.12LB, 70.14LB, 70.34PX/Trac, 700M/H, 720M/H, 704M/H, 724M/H, 701-4, 701-4F, 75-32MA/ME/MS/MX/TX, 75-34ME/M, 750MI, 745MI, 800M, 804M, 850M, 751 751, 751-4, 752, 781, 78, 80 MWM D305-3R, 80 MWM D325-3R, 80 (7282) 86 (7281), 80-12, 80-14, 85.34MX, 85.34TX, 80-12SP, 80-14SP, 80-12TX, 80-14TX, 80-32PA/PE/PS/PX, 80-34PA/PE/P, 80S/V MWN D327, 85-12LS/TS/TX, 85-14LS/TS/TX, 85- 32MA/ME/MS/MX/TX, 85-34MA/M, 85.12LS 85.14LS, 851, 851-4, 851-4S, 86, 88 598-, 89 MWM D226-3, 891, 891-4, 90.34MX/Tracfor, 90.34TX91TP91, 900MIH, 904MIH, 90S/V/ Conf., 92, 921 921-4, 95-12RE/RS/TS/TX, 95-14RE/RS/T, 95.12TX 95.14TX, 981 981-4, Ceres65, Ceres70, Ceres70X, Ce, Ceres85, Ceres85X, Ceres95, Ce, Master 1, Master 1 TP, Master, MWM D325-4R, 226-4, 325-4, D22, R301, R351M, R32-50EV-SV-V, R32-60F-V(A/B),, R361, R421-421M, R461, R461M,, R42-70V, R44-70F, R90S Verger,, R50, R51, R56, R60, R70, R80,, R50S, R53, R55, R551, R551S, R551-4, R551-4S,, R651, R651S, R651-4, R651-4S,, R751, R751S, R751-4, R751-4S,, R782, R782-4, R851, R851-4, R8, R89, R92, R489, R891, R891S, R891-4S, R951, R9, R91, R94, R96, R98, R496, R498, Super 5D, Super 7, Super 7D	6005000894, 6005007409
02742	5	Tipo Cav Lungo - rif. orig. CAV 7111-796/ Long cav type - orig. ref. CAV 7111-796		110-54TA/TE/TS/TX/TZ, 120-54TA, 133-12TS/TX, 133-14RE/ TA/TS/TX, 58-12LS, 58-14LS, 61-12RA/RS,, 58-32MA/ME/ MS/MX, 58-34MA/ME/M, 650MI	6005000895, 6005007410

02731	5	Tipo CAV 296 basso - rif. orig. CAV 7111-296/ Type CAV 296 short - orig. ref. CAV 7111-296	RUGGERINI	833	-
-------	---	---	-----------	-----	---

Art./Ref.	Pos.	Note/Note	Brand	Applicazione/Application	Rif. Orig./Orig. Ref.
<b>02731</b>	5	Tipo CAV 296 basso - rif. orig. CAV 7111-296/ Type CAV 296 short - orig. ref. CAV 7111-296	<b>SAME</b>	ANTARES 100, ASTER 60, ASTER 70, AURORA 45, BUFFALO 120, CENTAURO 70 EXPLORER, CENTAURO 70 SPECIAL, CENTURION 75, CENTURION 75 EXPLORER, CENTURION 75 SPECIAL, CONDOR 55, CONDOR C, CORSARO 70 FRUTTETO, CORSARO 70 SYNCRO, DELFINO 35, DELFINO 35 FRUTTETO, DRAGO 100, EXPLORER 70 C, EXPLORER 55, EXPLORER 60, EXPLORER 60 SPECIAL, EXPLORER 65, EXPLORER 65 C, EXPLORER 65 SPECIAL, EXPLORER 70, EXPLORER 70 SPECIAL, EXPLORER 75, EXPLORER 75 C, EXPLORER 75 SPECIAL, EXPLORER 80, EXPLORER 80 C, EXPLORER 90 C, EXPLORER 90 II SPECIAL, EXPLORER 90 SPECIAL, EXPLORER II 60, EXPLORER II 60 SPECIAL, EXPLORER II 70, EXPLORER II 70 SPECIAL, EXPLORER II 70 SPECIAL B, FRUTTETO 60, FRUTTETO 60 II, FRUTTETO 75, FRUTTETO 75 II, FRUTTETO 85 II, LEOPARD 85, LEOPARD 85 EXPLORER, LEOPARD C, MERCURY 85 EXPLORER, MERCURY 85 SPECIAL, MINITAURO 60, MINITAURO 60 FRUTTETO, MINITAURO C, MINITAURUS 60 FRUTTETO, MINITAURUS 60 SYNCRO, PANTHER 95, RANGER 45, RANGER 45 FRUTTETO, ROW CROP 80, ROW CROP 85, ROW CROP 90, SAME ROCK 55, SAME ROCK 60, SAME ROCK 70, SATURNO 80, SATURNO 80 SYNCRO, SOLAR 50, SOLAR 55 C, SOLAR 60, SOLAR 60 C	2.4319.060.1
<b>02742</b>	5	Tipo Cav Lungo - rif. orig. CAV 7111-796/ Naphtha, Cav long - orig. ref. CAV 7111-796	<b>SAME</b>	ANTARES 110 - 110 II, ANTARES 130 - 130 II, BUFFALO 3000, DRAGO 100 - 120, GALAXI 170, JAGUAR 95 - 100 EXPORT, LASER 100, LASER 110, LASER 125, LASER 130, LASER 150, LASER 90, LEOPARD 90 TURBO, PANTHER 90 - 95, SUPER-TITAN, TIGER 100, TIGER SIX 105 EXPORT, TITAN 145, TITAN 150, TITAN 160, TITAN 165, TITAN 190, TRIDENT 130 EXPORT	2.4319.130.1
<b>02742</b>		Tipo Cav Lungo - rif. orig. CAV 7111-796/ Naphtha, Cav long - orig. ref. CAV 7111-796	<b>STEYR</b>	M9078A, Valmet 420.81, 420., M9086 Valmet 420.81, 420.82., M9094 Valmet 420.81, 420.	P945X

**RICAMBI PER FILTRI COMPLETI ADATTABILI VARI BRAND**

RECHANGES POUR FILTRE TYPE ADAPTABLE MARQUES DIVERSES

PARTS FOR COMPLETE FILTERS ADAPTABLE VARIOUS BRANDS

ERSATZTEILE FILTER PASSEND ZU VIELZAHL VON MARKEN

RECAMBIOS PARA FILTROS COMPLETOS ADAPTABLE DIFERENTES MARCAS

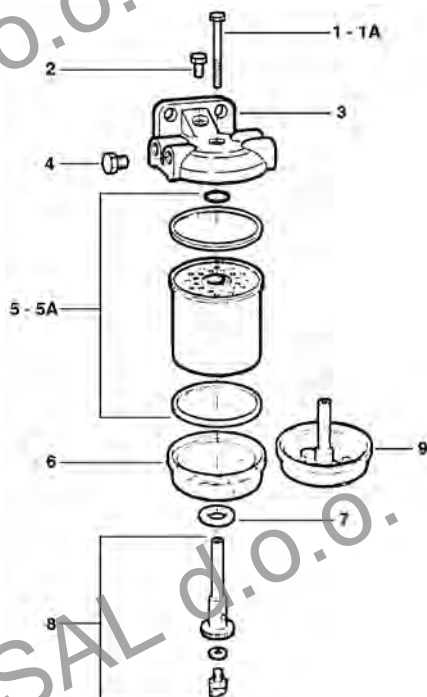

Art./Ref.	Pos.	Note/Note
<b>06281</b>	1	Prigioniero coperchio filt o tipo ""ALTO""/Filter head bolt ""HIGH"" type
<b>06279</b>	4	Tappo chiusura lat. coperchio passo decimale/Lat. closing decimal filter head bolt
<b>06280</b>	4	Tappo chiusura lat. coperchio passo pollice/Lat. Closing inch filter head bolt/plug
<b>40506</b>	10	Raccordo 1/2 Unf - Fitting 1/2 Unf
<b>40507</b>	11	Raccordo 90°-Fitting 90°/90° Fitting

**POMPE NAFTA A MEMBRANA ADATTABILI**

POMPES GASOIL A MEMBRANE ADAPTABLE  
 DIAPHRAGM FUEL PUMP ADAPTABLE  
 DIESELKRAFTSTOFFPUMPE PASSEND ZU  
 BOMBA NAFTA DE MEMBRANA ADAPTABLE



Art./Ref.	Tipo BCD/Tipo BCD	Brand	Applicazione/Application	Rif. Orig./Orig. Ref.
03612	1949/5	BRAUD	1214, SB52, SB54, SB56, SB58, SB60, SB62, SB64	4757884
02106	2567	CARRARO	600 MOT. PERKINS 4.236, 700 MOT. PERKINS 4.236, 800 MOT. PERKINS 4.248	910602, AK-063/0
03613	2558		315, 340, 425, 430, 452 DT, 454 455 C, 504, 515, 575, 604 MOT. 315, 655 CL MOT. 425, 704 MOT. 505, 954 MOT. 575, CARRO 4500 CS MOT. 285, MOT. 285, MOT. 450 DT, TR. 502, TR. 602, TR. 650 DT, TR. 702, TR. 952, VICTORY 7100 N & 4RM MOT. 425, VICTORY 7500 N & 4RM MOT. 505, VICTORY 8800N MOT 575, VICTORY 9800DF	30332, 30333
40431	2697	CASE	CX100, CX70, CX80, CX90	295976A1, 427309A1
03680	1662/7	DEUTZ	13006, 15, 2505, 2506, 2807, 30, 3005, 3006, 3006F, 3607, 3607F, 40, 40/2, 4005, 4006, 4006F/S, 4006U, 4007, 4007F, 4007U, 40964, 4505, 4506, 4506F, 4506US, 4507, 4507A, 4507C, 4507F, 4807, 4807A, 4807C, 4807F, 50, 5005, 5006, 5006F, 5006U, 5206, 5206F, 5206U, 5207, 5207A, 5207C, 5207F, 55, 5505, 5506, 5506F, 5506U, 6006, 6006F, 6006U, 6007, 6007A, 6007C, 6007F, 6206, 6206F, 6206U, 6207, 6207A, 6207C, 6207F, 6507, 6507A, 6507C, 6507F, 6806, 6806F, 6806U, 6807, 6807A, 6807C, 6907, 6907C, 7006, 7006F, 7006U, 7007, 7007A, 7007C, 7206, 7206A, 7206F, 7206U, 7207, 7207A, 7207C, 7505, 7505F, 7505U, 7506, 7506F, 7506U, 7807, 7807A, 7807C, 80, 9005, 9005F, 9005U, 9006, 9006A, 9006F, 9006U, AGROCOMPACT 3.30V/F, AGROCOMPACT 3.50S, AGROCOMPACT 3.50V/F, AGROCOMPACT 3.70V/F, AGROCOMPACT 3.90F, AGROCOMPACT 3.90S, AGROLUX 60, AGROLUX 70, AGROLUX 90, AGROPLUS 60, AGROPLUS 70, AGROPRIMA 4.31, AGROPRIMA 4.36, AGROPRIMA 4.46, AGROPRIMA 4.56, AGROPRIMA 6.06, AGROPRIMA 6.16, AGROSTAR 4.61, AGROSTAR 4.71, AGROSTAR 6.11, AGROSTAR 6.31, AGROSTAR 6.61, AGROSUN 100, AGROSUN 120, AGROSUN 140, AGROXTRA 3.57, AGROXTRA 4.07, AGROXTRA 4.17, AGROXTRA 4.47, AGROXTRA 4.57, AGROXTRA 6.07, AGROXTRA 6.17, BF4L 913, BF4L 913T, BF6L 912, BF6L 913, BF6L 913T, DX110, DX110A, DX120, DX120A, DX140, DX140A, DX145, DX145A, DX160, DX160A, DX230, DX230A, DX250, DX250A, DX250V, DX3, DX3.10SC, DX3.10V, DX3.10VC, DX3.3.50V/F, DX3.30SC, DX3.30VC, DX3.50S, DX3.50SC, DX3.50VC, DX3.60SC, DX3.60VC, DX3.65SC, DX3.65VC, DX3.70SC, DX3.70V/F, DX3.70VC, DX3.75VC, DX3.80SC, DX3.90F, DX3.90S, DX3.90SC, DX3.90VC, DX3500, DX36, DX3700, DX3900, DX4.10, DX4.11, DX4.30, DX4.31, DX4.50, DX4.51, DX4.61, DX4.70, DX4.71, DX50, DX55, DX6.05, DX6.06, DX6.10, DX6.30, DX6.50, DX7.10, DX80, DX80A, DX85, DX85A, DX86, DX86A, DX90, DX90A, DX92, DX92A, DXAB 110, DXAB 120, DXAB 145, DXAB 160, DXAB 80, DXAB 85, DXAB 86, DXAB 90, DXAB 92, DXBIS 110, DXBIS 120, DXBIS 140, DXBIS 145, DXBIS 160, DXBIS 85, DXBIS 90, F1L 812, F2L 812, F2L 912, F3L 812, F3L 812D MOT., F3L 812S, F3L 912/912W, F3L 913, F4L 812S, F4L 912, F4L 912/912W MOT., F4L 913, F4L 812D MOT., F5L 912/912W, F6L 812D MOT., F6L 912/912W, F6L 913, HOPFEN DX4.17, HOPFEN DX4.57, INTRAC 2002, INTRAC 2003, INTRAC 2004, INTRAC 2005, INTRAC 2006, INTRAC 6.30, INTRAC 6.30T, INTRAC 6.50	04231021, 2100087, 2134511, 2239550, 3363174, 4150197, 4157603, 4167698, 4230294, 4230566, 4231021, KZ0150-17, UC0150-17

Art./Ref.	Tipo BCD/Tipo BCD	Brand	Applicazione/Application	Rif. Orig./Orig. Ref.
<b>00754</b>	1947/5	<b>FIAT</b>	350, 355, 400, 420, 45-66, 45-66DT, 45-66S, 45-66SDT, 45-76V, 450, 450 DT, 455, 455C, 470, 480, 50-66, 50-66DT, 50-66S, 50-66SDT, 50-86SV, 50-86SVDT, 50-86V, 50-86VDT, 500, 500 DT, 500 DT SPECIAL, 505, 505C, 540, 55-46, 55-46DT, 55-56, 55-56DT, 55-65F, 55-65M, 55-65L, 55-66, 55-66DT LP, 55-66F, 55-66FDT, 55-66LP, 55-66S, 55-66SDT, 55-66V, 55-66VDT, 55-75F, 55-75M, 55-75V, 55-76F, 55-76FDT, 55-76V, 55-76VDT, 55-85F, 55-85M, 55-85V, 55-86F, 55-86FDT, 55-86SV, 55-86SVDT, 55-86V, 55-86VDT, 55-88, 55-88DT, 55-90, 55-90DT, 550, 550 DT, 555, 56-66S, 56-66SDT, 580, 60-46, 60-46DT, 60-56DT, 60-65, 60-65M, 60-65V, 60-66, 60-66DT, 60-66F, 60-66FDT, 60-66LP, 60-66LPDT, 60-66S, 60-66SDT, 60-75, 60-75M, 60-75V, 60-76F, 60-76FDT, 60-85F, 60-85V, 60-86F, 60-86FDT, 60-86SV, 60-86SVDT, 60-86V, 60-86VDT, 60-88, 60-88DT, 60-90, 60-90DT, 60-93, 60-93DT, 60-94, 60-94DT, 600 DT, 600 DT3, 605, 605C, 62-85, 62-85M, 62-86F, 62-86FDT, 640, 640 DT, 65-46, 65-46DT, 65-56, 65-56DT, 65-66, 65-66DT, 65-66S, 65-66SDT, 65-88, 65-88DT, 65-90, 65-90DT, 65-93, 65-93DT, 65-94, 65-94DT, 70-56, 70-56DT, 70-65, 70-65M, 70-66, 70-66DT, 70-66F, 70-66FDT, 70-66LP, 70-66LPDT, 70-66S, 70-66SDT, 70-66V, 70-75, 70-75M, 70-76F, 70-76FDT, 70-76LP, 70-76LPDT, 70-76V, 70-86SV, 70-86SVDT, 70-86V, 70-86VDT, 70-88, 70-88DT, 70-90, 70-90DT, 72-85, 72-85M, 72-86F, 72-86FDT, 72-86LP, 72-86LPDT, 72-93, 72-93DT, 72-94, 72-94DT, 80-65, 80-66, 80-66DT, 80-66F, 80-66FDT, 80-66S, 80-66SDT, 80-75, 80-76F, 80-76FDT, 80-88, 80-88DT, 80-90, 80-90DT, 82-85M, 82-86F, 82-86FDT, 82-86LP, 82-86LPDT, 82-93, 82-93DT, 82-94, 82-94DT, 85-55, 85-90, 85-90DT, 88-85M, 88-93, 88-93DT, 88-94, 88-94DT, OM CARRELLI DI12 - DI15 3 CIL, OM CARRELLI DI20 - DI25 3 CIL, OM CARRELLI DI20C 3 CIL, OM CARRELLI DI25C 3 CIL, OM CARRELLI DI30 - DI35 4 CIL, OM CARRELLI DI30C 3 CIL, OM CARRELLI DI30CH 4 CIL, OM CARRELLI DI35C - DI50 4 CIL, OM CARRELLI DI40 - DI40C 4 CIL, IDROVERT S60, IDROVERT SH 150 8045.25.380, IDROVERT TL5 - TL5H, AD4, FL4, FL4/C, FL4/C MOT. 8035.01.265, FL4/D, FL4/L, IDROVERT TL5, PALA MEC. FL4/D, S60, TL5H AD4, FL4, FL4/C, FL4/C MOT. 8035.01.265, FL4/D, FL4/L, IDROVERT TL5, PALA MEC. FL4/D, S60, TL5H	4609596, 4660068, 4667510, 4709283, 4740717, 4740718, 4756678, 4757883, 4757883, 4609596, 4660068, 4667510, 4709283, 4740717, 4740718, 4756678, 4757883
<b>03612</b>	1949/5		100-90, 100-90DT, 1000, 1000 SUPER, 1000DT, 1000N, 1000S, 110-90, 110-90DT, 1180, 1180DT, 1280, 1280DT, 666, 670, 680, 780, 805, 855 (6 CIL.), 880, 880-5, 90-90, 90-90DT, 95-55 CRAWLER TRACTOR, 955, 980	4673618, 4709284, 4740719, 4757884
<b>03629</b>	2591		35.66, 35.66 DT	9963402
<b>15395</b>	50043040		FL4	79047864, 8313527, 8331527, MOD763150
<b>00754</b>	1947/5		3010S, 3435, 3830, 3935, 4010S, 4030, 4135, 4230, 4430, 4635, 4835, 5010S, 5635, 6635, 7635	4757883
<b>03630</b>	1533/2A		D1000 SERIE V8.511 & 511, MOT. 4CIL. CON SIMMS P4594P463, MOT. 4CIL. CON SIMMS P4632/33/, TR. 3000, 5000, 8000, 9000, TR. SUPER DEXTA, SUPER MAJOR 5	510E9350
<b>03639</b>	1858	<b>FORD</b>	1118, 2150, 220, 3000, 3055, 3100, 3110, 3120, 3150, 3190, 3300, 3310, 333, 3330, 335, 3400, 3500, 3550, 3600, 5000, 5100, 5110, 5190, 5200, 5340, 5500, 5600, 5610, 5900, 6410, 655, 6550, 655A, 6600, 6600C, 66000, 6610, 66100, 6700, 6710, 6810, 7000, 7100, 7200, 7410, 7550, 7600, 7600C, 7610, 76100, 7700, 7710, 7810, 78100, 7910, 8000, 8200, 8210, 8530, 8600, 8630, 8700, 8730, 8830, 9000, 9200, 9600, 9700, BSD329, BSD438, BSD442, BSD442T, BSD444, BSD444T, BSD666, BSD666T, BSD666TI, MAJOR (DIESEL), POWER MAJOR (DIESEL), SUPER MAJOR (DIESEL), TW10, TW15, TW25, TW35, TW5	83991467, D8NN9350AB
<b>03655</b>	1796		1118, 2150, 220 ENGINE, 3000, 3100, 3120 INDUSTRIAL, 3150, 3150 RICE VERSION, 3190, 3300, 3310, 333 INDUSTRIAL, 3330, 335 INDUSTRIAL, 3400 INDUSTRIAL, 3500, 3500 INDUSTRIAL, 3550, 3600, 5000, 5100, 5110, 5190, 5200, 5340, 5500 BACKHOE LOADER, 5550 INDUSTRIAL, 5610, 5900, 6410, 655 INDUSTRIAL, 6550 INDUSTRIAL, 655A INDUSTRIAL, 6600, 6600C, 6610, 66100, 6700, 6710, 6810, 7000, 7100, 7200, 7410, 7550 INDUSTRIAL, 7600, 7600C, 7610, 76100, 7700, 7710, 7810, 78100, 7910, 8000, 8200, 8210, 8530, 8600, 8630, 8700, 8730, 8830, 9000, 9200, 9600, 9700, BSD329 ENGINE, BSD438 ENGINE, BSD442 ENGINE, BSD442T ENGINE, BSD444 ENGINE, BSD444T ENGINE, BSD666 ENGINE, BSD666T ENGINE, BSD666TI ENGINE, MAJOR, POWER MAJOR, SUPER MAJOR, TW10, TW15, TW20, TW25, TW30, TW35, TW5	510E9350, 81846098, 81859378, 83912071, 83991467, 84749024, D3NN9350A, D8NN9350A, D8NN9350AA, D8NN9350AB

Art./Ref.	Tipo BCD/Tipo BCD	Brand	Applicazione/Application	Rif. Orig./Orig. Ref.
02110	1930/5		H6160	2.4519.220.2, 2.4519.230/10, 2.4519.290.0
03674	1991/5 - 2625/1	HURLIMANN	H305XE, H306XE, H307XE, H356, H358, H358 PRESTIGE, H358.4 CLUB, H361, H361XF, H362, H372, H4105 ELITE, H466, H468, H468 PRESTIGE, H468.4 CLUB, H476, H476 XF, H478, H478 PRESTIGE, H478.4, H481 XF, H486, H488, H488T PRESTIGE, H491 XF, XA606, XA607, XT908, XT909, XT910.4, XT910.6	2.4519.300.0, 2.4519.310.0
03631	1780	INTERMOTOR	MOT. LA400 E DERIVATI, MOT. LA490 E DERIVATI	6585.006
00754	1947/5	IVECO	8045.06.200 TRATTORE, AIFO 8041.25.200, D.8031.05.30 INDUSTRIAL, D.8035.05.200 INDUSTRIAL, D.8035.05.208 INDUSTRIAL, D.8035.05.265 INDUSTRIAL, D.8035.05.308 INDUSTRIAL, D.8035.05.359 INDUSTRIAL, D.8035.06.240 INDUSTRIAL, D.8035.06.309 INDUSTRIAL, D.8035.06.340 INDUSTRIAL, D.8035.06.342 INDUSTRIAL, D.8035.06.343 INDUSTRIAL, D.8041.05.200 INDUSTRIAL, D.8041.05.206 INDUSTRIAL, D.8041.05.306 INDUSTRIAL, D.8045.05.200 INDUSTRIAL, D.8045.05.201 INDUSTRIAL, D.8045.05.204 INDUSTRIAL, D.8045.05.206 INDUSTRIAL, D.8045.05.207 INDUSTRIAL, D.8045.05.209 INDUSTRIAL, D.8045.05.307 INDUSTRIAL, D.8045.05.322 INDUSTRIAL, D.8045.05.346 INDUSTRIAL, D.8045.05.359 INDUSTRIAL, D.8045.05.370 INDUSTRIAL, D.8045.05.389 INDUSTRIAL, D.8045.06.206 INDUSTRIAL, D.8045.06.320 INDUSTRIAL, D.8045.25.305 INDUSTRIAL, D.8045.25.370 INDUSTRIAL, D.8045.25.375 INDUSTRIAL	4757883
03612	1949/5		8055.05.200 - 8065.05.200, 8055.25.200 (5 CIL.), 8061.25.200 (6 CIL.), 8065.06.200, 8065.25.200 TURBODIESEL, AIFO 8051.05.200	4757884
03632	1943	JOHN DEERE	1020 (MOT.3152D ->085099), 1020 (MOT.3164D 085100->), 1030VU, 1035, 1035EF, 1035EV, 1040V, 1130, 1140F, 1140V, 1350, 1445F, 1550, 16300U, 1630VU, 1635, 1635EF, 1635EV, 1640F, 1745F, 1750, 1750V, 1830, 1840F, 1845F, 1850F, 1850N, 1850V, 1950F, 1950N, 2020, 20300U, 2035, 2035EF, 2040F, 2120, 2135, 2150, 2155, 2255, 2345F, 2355, 2450F, 2550, 2555CS, 2555TSS, 2650, 2650CS, 2650F, 2650N, 2650TSS, 2750, 2755, 2840, 2855N, 2940, 2950, 2955, 3030, 3040, 3050, 3055, 3100, 3120, 3155, 3164D, 3179T, 3340, 3640, 3640S, 3650, 4040S, 4202D, 4239D, 510, 6359T, 710, 820, 840, 920, 930, 940V, MOT.3152D, MOT.4202D, MOT.4219D, MOT.6303D, MOT.6359D	461/66, 5507919, AJ52379, AR34415, AR76030, AR77914, AR92776, AR92777, DD13483, DD14195, DD14292, DE16748, DE17836, DE19070, RE37482, RE527115
02107	1910/5		C362, C453, C553, 6653 MOT. SAME 3 CIL., C684, C754, C784, R235 MOT. SAME 2 CIL., R654, R660, R854 MOT. SAME 4 CIL.	0.003.8319.6/10, 2.4519.160.0, 2.4519.190.0/10
02110	1930/5		R1056, R653, R754, R854	2.4519.220.2, 2.4519.230/10, 2.4519.290.0
03633	1911/5	LAMBORGHINI	R1056 MOT. SAME 6 CIL.	2.4519.140.0, 2.4519.150.0, 2.4519.180.0, 2.4519.200.0/10
03674	1991/5 - 2625/1		105 FORMULA, 1050 PREMIUM, 1060 PREMIUM, 574-60N CROSS, 660-F PLUS, 674-70, 674-70 CROSS, 674-70 GRAND PRIX, 674.5, 774-80, 774-80 GRAND PRIX, 775-F PLUS, 850 PREMIUM, 874-90T, 874-90T GRAND PRIX, 880-F PLUS, 950 PREMIUM, 956-100, 990-F PLUS, C674, C674-70 ERGOMATIC, C774-80 ERGOMATIC, C874-90 ERGOMATIC, CRONO 554-40, CRONO 564-60, CRONO 574-70, HIGH CLEARANCE 90, R1106, R1306, R600, R674, R700, R774, SPRINT 664-60, SPRINT 674-70	2.4519.300.0, 2.4519.310.0

Art./Ref.	Tipo BCD/Tipo BCD	Brand	Applicazione/Application	Rif. Orig./Orig. Ref.
02106	2567		6550, 6830, 6860, 7830, 7860, 8550, 8830, ADVANTAGE CAB E F.S.: 65, ADVANTAGE CAB E F.S.: 75, BLIZZARD: 65, BLIZZARD: 75, CINGOLATI: C7830, CINGOLATI: C6830, CINGOLATI: CF6830, FRUTTETI 530 F/L/V: 7530, FRUTTETI 530 F/L/V: 6530, FRUTTETI 530 F/L/V: 8530, FRUTTETI 560 F/L/V: 6560L/V, FRUTTETI 560 F/L/V: 7560L, R7500 MOT. PERKINS 4.236, TR. R6500, TR. R6550MOT. PERKINS 4.236, TREKKER: C75, TREKKER: CF65, TREKKER: CF70, TREKKER: CF75, VIGNETI CAB E F.S.: 65V, VIGNETI CAB E F.S.: 75V	3637290M91
02108	1812		4000/DT, 4000R, 4000S, 4500R, 5000/DT, 5000/N, 5000/S, 5000R, 5500, 5500 4RM MOT. PERKINS 3.152, 5830, 5840, 5860, 5870, 6030, 6040, 6060, 6070, ADVANTAGE CAB E F.S.: 55, ADVANTAGE CAB E F.S.: 60, BLIZZARD: 50, BLIZZARD: 60, C5000, CINGOLATI: C5000, CINGOLATI: C5500, CINGOLATI: C5830, CINGOLATI: CF4830, CINGOLATI: CF5830, CINGOLATI: CF6030, CINGOLATI: CF6060, CINGOLATI: C4500, CINGOLATI: CF5030, FRUTTETI 530/F/L/V: 4530, FRUTTETI 530/F/L/V: 5530, FRUTTETI 530/F/L/V: 6030, FRUTTETI 560 F/L/V: 4560, FRUTTETI 560 F/L/V: 5560, FRUTTETI 560 F/L/V: 6060, GLOBUS: 50, GLOBUS: 55, NEW SERIE 60: 5860, PERKINS D3.152 C5500, REX CAB E F.S.: 60, TR. 4500, TREKKER: CF55, TREKKER: CF60, VIGNETI CAB E F.S.: 55V, VIGNETI CAB E F.S.: 60V, VIGNETI REX CAB: 60V, VIGNETI REX CAB: 65V	3637307M91, 4222111M91
02111	1987		4530V-5530F-5530L-5530-5830, 5500, 5560F-5560L-5560V, 5840-6040, 5860, 5870-6070, 6030-6030F-6030L-6030V, 6060-6060F-6060L-6060V, ADVANTAGE55F-FP-GE-GT-GTP-L-LP, ADVANTAGE60F-FP-GE-GT-GTP-L-LP, BLIZZARD 60, C4830-CF4830, C6030F, CF5030, CF5830, CF6060, GLOBUS 55, TREKKER 60F, VIGNETI 60V	994183, 994295, ULPK0004
03634	1695/1		4000, 4000 SPECIAL, 4530V, 4560V, 5000, 5000 R-S, 5000 SPECIAL, 5000DT, 5000R-N, 5500, 5530F, 5530L, 5530V, 5560F, 5560L, 5560V, 5830, 5840, 5860, 5870, ADVANTAGE 55F, ADVANTAGE 55FP, ADVANTAGE 55GE, ADVANTAGE 55GT, ADVANTAGE 55GTP, ADVANTAGE 55L, ADVANTAGE 55LP, ADVANTAGE 55V, BLIZZARD 50, C4500, C4830, C5500, C5830, CF4830, CF5030, CF5830, GLOBUS 50, MF 244, TREKKER 50F, TREKKER 55F, TREKKER CF55	25061520, ULPK0018
03635	1752/1		6000, 6000 SPECIAL, 6500, 6505, C6000, TR. 6500 MOT. PERKINS 4.203, TR. TL16N MOT. PERKINS D4.203	ULPK0010
03638	1942/1	LANDINI	10000, 12500, 13000, 14500, 16500, 9500, LEGEND 105, LEGEND 115, LEGEND 130, LEGEND 130 BLU, LEGEND 145, LEGEND 160 BLU, LEGEND 165, LEGEND N/G: 115, LEGEND N/G: 120, LEGEND N/G: 130, LEGEND N/G: 180, MYTHOS 110, TR. 10500, 12500, 13500 MOT. P, TR. 12500, 14500, 14500 4RM MO, TR. MF 1100, 1134, 14500 MOT., TR. R9000 MK II, R9500 MK II 4	2641719, 2641720, 2641729, 2641A070, 3641400M91, ULPK0002
03639	1858		6500, 7000 SPECIAL, 8000/DT, 8000R, C6500, TR. 8000 MOT. PERKINS 4.248	ULPK0011
03643	1529/1		4A/203, 6000DT, 6000R, 6000S, 7000R, C6000, TR. 6000 MOT. PERKINS 4A/192	ULPK0009
03646	1687/1		LARGE 10000, TR. MF 1104, R9500 MOT. PERKIN, TR. TL19N/A, R9500 MOT. PERKIN	ULPK0007
03652	2522/5		-	ULPK0008
03659	2563		12500, 14500	ULPK0022
14239	1873/5		6500, 6530F, 6530L, 6530V, 6550, 6560L, 6560V, 65F, 65FP, 65GE, 65G, 65GTP, 65L, 65LP, 6840, 6860, 6870, 6880, 6880VM, 68CV, 7000S, 7500, 7505, 7530F, 7530L, 7550, 7560L, 7560V, 75F, 75FP, 75GE, 75GT, 75GTP, 75L, 75LP, 7830, 7860, 7860HC, 7870, 7880, 7880VM, 78CV, 8500, 8530L, 8550, 8560L, 85FP, 85GE, 85G, 85LP, 8830, 8860, 8870, 8880, 8880HC, 88CV, 9060, 9080, 9080HC, 9880, 9880HC, ADVANTAGE CAB: L95, ADVANTAGE CAB E F.S.: 85, BLIZZARD 65, BLIZZARD 75, BLIZZARD: 85, BLIZZARD: 95, C6830, C7830, CF6830, CINGOLATI: C8860, CINGOLATI: C7800, CINGOLATI: C6500, FRUTTETI 530 F/L/V: 8530F, FRUTTETI 560 F/L/V: 8560, FRUTTETI 560: 6560F, FRUTTETI 560: 7560F, GLOBUS 55, GLOBUS 60, GLOBUS 70, REX 90GE, TR. 6400, 6500 MKII, MKII 4RM,, TR. 6830, TR. 7500, TR. 7500 4RM, TR. 8500, TR. 85004RM, TREKKER 65F, TREKKER 70F, TREKKER 75F, TREKKER 80F, TREKKER C75, TREKKER C85, TREKKER CF60, TREKKER CF70, TREKKER CF75, TREKKER CF85, TREKKER: C 95, VIGNETO 65V, VIGNETO 75V	1447017M91, 1447688M91, 2641A053, 2641A073, ULPK0003
40431	2697		6860NG, 7860NG, 8860NG, ATLANTIS 100, ATLANTIS 70, ATLANTIS 75, ATLANTIS 80, ATLANTIS 85, ATLANTIS 90, ATLAS 100, ATLAS 70, ATLAS 75, ATLAS 80, ATLAS 85, ATLAS 90, GHIBLI 100, GHIBLI 80, GHIBLI 90, GLOBUS 65, GLOBUS 75, GLOBUS 80, MHYTOS 100, MHYTOS 90, REX 100FP, REX 100GE, REX 100GTP, REX 70FP, REX 70GE, REX 70GTP, REX 70LP, REX 70V, REX 80FP, REX 80GE, REX 80GTP, REX 80LP, REX 80V, REX 90FP, REX 90GE, REX 90GTP, REX CAB 100, REX CAB 70, REX CAB 80, REX CAB 90, TREKKER 100C, TREKKER 70C, TREKKER 70F, TREKKER 70L, TREKKER 80C, TREKKER 80F, TREKKER 80L, TREKKER 90C, TREKKER 90F, VIGNETI 70V CAB, VIGNETI 80V CAB, VISION 100, VISION 80, VISION 90	2641A052, 2641A067, ULPK0005, ULPK0034
03612	1949/5		3300AL, 3560AL	4757884
15395	50043040	LAVERDA	3300AL	MOD763150



Art./Ref.	Tipo BCD/Tipo BCD	Brand	Applicazione/Application	Rif. Orig./Orig. Ref.
<b>02109</b>	1927/5	<b>LOMBARDINI</b>	MOT. DIESEL (GR. 5, 7, 9, 10,, MOT. DIESEL LDA 672, LDA 673, MOT. DIESEL LDA 832, LDA 833	276.6585.11, 276.6585.30, 6416.6585.07, 6585.030, 672.6585.030
<b>03616</b>	1928/5		MOT. DIESEL 3LD 450, MOT. DIESEL 500, 503, 505, 507, MOT. DIESEL 520, 523, 525, 527, MOT. DIESEL LD450 GR. 3-4, MOT. DIESEL LDA 80, LDA 80B, M, MOT. DIESEL LDA 96	283.6585.031
<b>03640</b>	1899/5		MOT. DIESEL 8LD 600, 8LD 602 (, MOT. DIESEL 904 E DERIVATI	6585022, 904.6585.022, 904.6585.22
<b>03641</b>	1929/5		MOT. DIESEL 500, 520, 530, (GR, MOT. DIESEL 6LD 260 (GRUPPO 6)	500.6585.032, 6416.6585.27, 6585032

<b>02106</b>	2567	<b>MASSEY FERGUSON</b>	11 SHOVEL LOADER MOT. 4.248, 165 COMBINE MOT. 4.212, 168, 168 MK III/168F MOT. 4.236, 168 NARROW MOT. 4.236, 175 175S, 175/178 MOT. 4.236, 178 MOT. 4.248, 178/175S, 185/188 ENG. 248UA71961, 186 COMBINEMOT. 4.212 (, 188, 194 MOT. 4.248, 206, 265, 274, 275 MOT. 4.236, 285, 290 MOT. 4.248, 300, 307 COMB.HARVESTER MOT. 4.236, 33 MOT. 4.248 (2641725), 487 MOT. 4.248 (2641725), 50, 50 PHASE II SKIDMOT. 4., 50B INDUST. TDL, 565, 575 MOT. 4.236, 590 MOT. 4.248, 600 MOT. 4.236, 675, 690, ESCAVATORE MF350, INDUST. MF 30/50 MOT. 4.21, INDUST. MF50 MOT. 4.212, MF 184, MF 194 23 MOT. PERKINS 4.236, TR. MF 174, W350	1447688M91, 3637290M91, 3641402M91, 4222108M91
<b>02108</b>	1812		122, MF 133/135 VIGNETO MO, 134C, 134V, 135 MOT. 3.144, D3.152, 135, 135ET, 135MK III/1, 140, 140/140V/140 MK III/145, 145, 145S, 145V, 148 MK III/152152ET, 152, 148, MF 148/148V MOT. D, 150, 203, 2200 MOT. 3AD, 152, 152F, 152S, 154, 154C, 154F, 154S, 154V, 20, 205, 20B, 20C, 20D, 20E, 2135, 2203, 2205, 230, 233, 234C, 234CF, 234S, 235, 245, 255 MOT. D3.1, 240, 250, 550 MOT.D3. 15, 244CF, 253 ITALY, 254, 254C, 254CF, 254S, 30B, 30H, 35, DX35, DX40, IX210 MOT. 3AD., I.C.M. APRILIA MF100C MOT.	3637307M91, 4222111M91, 886062M1
<b>02111</b>	1987		122 MOT. D3. 152 O.E. N. 26, 133/135 MOT. D3.152, 135, MF135/2135 MOT. D3, 148 MOT. D3.152, 155, 158F, 158S, 158V, 235, 245, 255 MOT. D3.1, 244, 260, 40B INDUSTRIAL, 550 MOT. D3.152, 560, I.C.M. APRILIA MF 100C MOT, IND. MF 2203-7,2205-7 MOT., TR. MF 244 MOT. PERKINS D3.152	3637322M91, 4222090M91, 4222121M91
<b>03634</b>	1695/1		122 MOT. 3.152, 133, 135 MOT. 3.152, 152UA38570, 135, 203, 205 MOT. A3.152, 135/135ET135MK III/135V, 140, 145, 145S, 148, 150, 152, 152F, 152S, 152V, 154, 154C, 154F, 154S, 154V, 20 INDUSTRIAL, 2135 INDUSTRIAL, 2203 INDUSTRIAL, 2205, 30B INDUSTRIAL, 35, 35X, MF 244	3637288M91, 4222094M91, 885363M91, 890960M1
<b>03635</b>	1752/1		1004, 1080, 1085, 155 AD4.203, 155/158 MOT. 4.318, 158F, 158S, 158V, 165, 195 MOT.4A.318 TR.MF 26, 260, 298, 300, E302F 304, 365, 302, 304, MF 365 MOT. 4AD.20, 3165, 3303, MF3305 MOT. 4AD.20, 3305, 356, 40B, 50, 560 MOT. 4.203, 560 MOT. D4.203, 592 MOT. 4.318, 595 MOT. 4.318, 4.318.2, 598 MOT. 4.318, 65, 698, 70, 765 MOT. 4AD.203, 4AD203	1446155M91, 1447633M91, 2641328, 3637286M91, 3639013M1, 4222107M91, 886100M91
<b>03637</b>	1829/1		630 MOT. 4.107	2641702, 3637979M91
<b>03638</b>	1942/1		1014, 1024, 1114 (U711700L->), 1134, 1250, 2720, MF 350 MOT., 2620, MF 2640, MF 2680, 2625, 2645, 2675, 2685, 2705, 2725, 297, 299, 3080, 3085, 3090, 3095, 3115, 3120, 3120T, 3125, 3140, 3610, 3630, 3635, 3645, 3650, 3660, 396, 399, 4260, 4270, 4360, 6160, 6170, 6180, 6190, 6260, 6270, 6280, 6290, 699, 8110, 8120, 8130, 8220, RX8533C 530, 2620, 2680	1446951M91, 1447535M91, 3641400M91, 4222105M91
<b>03639</b>	1858		165 COMBINE MOT. 4.212, 178, MF185/188 MOT. 4.2, 487 COMBINE MOT. 4.248 MF 5, COMBINE MF 186 MOT. 4.212, DX65 MOT. 4A. 236, INDUST. MF 50 MOT. 4.212, MACCHINA AGRICOLA MF 33 MOT. 4, MACCHINA AGRICOLA MOT. 4.248	1447381M91, 3637287M91, 3637289M91, 4222104M91, 4223471M91
<b>03643</b>	1529/1		155, 158, 158F, 158S, 158V, 165 MOT. AD4 203, 30 INDUSTRIAL, 302 INDUSTRIAL, 304 INDUSTRIAL, 3165 INDUSTRIAL, 3303 INDUSTRIAL, 3305 INDUSTRIAL, 356 INDUSTRIAL, 50 INDUSTRIAL, 65, MK I-II MOT. P4-4.2, 765, 86-6 COMBINE MOT. 4AD 20, 865, CX65 MOT. 4AD/236	3637338M91, 4222121M91, 4222452M91, 890955M91, 892630M91, 986444
<b>03644</b>	1647/1		155, 158, 158F, 158S, 158V, 165, 30, 302, 304, 3165, 3303, 3305, 356, 400, 410, 50, 65, 765, 865, TR & COMBINES TE 20 MOT. 3.144	35275
<b>03645</b>	1660/1		130 MOT. PERKINS A4/107- A, 25, 30, 825	1446146M91, 1641103M91, 35205, 3637414M91, 4222174M91, 893159M91
<b>03646</b>	1687/1		1014, 1104, 1105, 1135, 1200, 500 COMBINE, 500, MF507, MF525MOT. 6., 515, 520, 620, 625, 740, 750, 760, D400C, MF1200 4 RUOTE MOTR, ESCAVATORE 450C MOT. 6354/1, ESCAVATORE MF 5400, 620/5, 336, MACCHINA AGRICOLA MF 400X/507,	3637309M91, 4222093M91, 892632M91
<b>03652</b>	2522/5		155, 158F, 158S, 158V, 260, 40B INDUSTRIAL, 560	3053177
<b>03655</b>	1796		309D SISU/VALMET, 310B SISU/VALMET, 310D SISU/VALMET, 311C SISU/VALMET, 311CS SISU/VALMET, 411AS SISU/VALMET, 411BS SISU/VALMET, 411C SISU/VALMET, 411CS SISU/VALMET, 411CX SISU/VALMET, 411DS SISU/VALMET	1446184M91, 1446681M91, 1447566M91, 3637289M91, 4223471M91

Art./Ref.	Tipo BCD/Tipo BCD	Brand	Applicazione/Application	Rif. Orig./Orig. Ref.
<b>03659</b>	2563	<b>MASSEY FERGUSON</b>	1114, MF 1134	2641701, 2641710, 2641715, 3637729M91, 4223583M91
<b>14239</b>	1873/5		1007, 168, 168F, 168S, 174, 174C, 174F, 174S, 174V, 175S, 184, 184F, 184S, 185, 188, 194, 194C, 194F, 194S, 273, 284, 284S, 285, 290, 373, 373LX, 373S, 374AP, 374AQ, 377, 383, 387, 393, 394, 396, 397, 50 INDUSTRIAL, 50B INDUSTRIAL, 50B MKII INDUSTRIAL, 50C INDUSTRIAL, 50E, 565, 575, 590, MF 175 DALLA SERIE 236UA57083, MF180 DALLA SERIE 236UA57265, MF184-4, MF255, MF265, MF270MF274-4 TR. SERIE 221N009, MF275, MF294-4 TR. SERIE 223000321, MF670, MF690; INDUSTRIALE: 31DALLA SER	1447017M91, 1447688M91, 3637300M91, 3641408M91, 4222091M91
<b>40418</b>			FE35, TEF20	826154M91
<b>40431</b>	2697		2230, 3075, 3220, 3330, 3330V, 3340, 3340GE, 3340S, 3340V, 3350, 3350F/FE, 3350GE, 3350S, 3355, 3355F/FE, 3355GE, 3355S, 374APX, 374FPX, 374GEX, 374SPX, 394APX, 394FPX, 394GEX, 394SPX, 4225, 4225HV, 4235, 4235HV, 4240, 4245, 4245HV, 4255, 4255HV, 4260, 4265, 4325, 4325HV, 4335, 4335HV, 4345, 4345HV, 4355, 4355HV, 4365, 5275, 5285, 5290, 6110, 6120, 6130, 6140, 6150, 6235, 6235HV, 6245, 6245HV, 6255, 6255HV, 6265, 750 FER- MEC, 760 FERMEC, 860 FERMEC, 8925 LOADER, 8925T LOADER, 8926 LOADER, 8926T LOADER, 8937 LOADER, 8937T LOADER, 8939 LOADER, 8939T LOADER, 960 FERMEC, 965 FERMEC	2010877, 3055623, 3639696M1, 3641308M91 422206M91, 4224451M91, 549553, 601824, 72081, 72111
<b>03638</b>	1942/1	<b>MCCORMICK</b>	MTX110, MTX125, MTX140, MTX155, MTX175, MTX200	ULPK0002
<b>40431</b>	2697			295976A1, ULPK0005, ULPK0034
<b>00754</b>	1947/5	<b>NEW HOLLAND</b>	L60, L65, L75, L85, L95, TD55D, TD65D, TD75D, TD85D, TD95D, TK65F, TK65V, TK75F, TK75M, TK75V, TK76, TK76M, TK85, TK85M, TK95M, TL100, TL65, TL70, TL80, TL90, TN55, TN55D, TN55S, TN55V, TN60A, TN60DA, TN60SA, TN65, TN65D, TN65F, TN65N, TN65S, TN65V, TN70D, TN70DA, TN70F, TN70SA, TN75, TN75A, TN75D, TN75DA, TN75F, TN75N, TN75S, TN75SA, TN75V, TN80F, TN90F, TN95F, TN95NA, TN95VA	4757883, 504090935
<b>03612</b>	1949/5		1214 BRAUD, SB52 BRAUD, SB54 BRAUD, SB56 BRAUD, SB58 BRAUD, SB60 BRAUD, SB62 BRAUD, SB64 BRAUD, TK100-55, TK95-55	4757884
<b>02108</b>	1812	<b>PERKINS</b>	3.152, 3AD.152, D3.152, 7 MOT. D3.152	2641309, 2641310, 2641311, 2641317, 2641A063, ULPK0006
<b>02111</b>	1987		AD4.203, D3.152, D3.152 INDUSTRIAL	2641704, 2641712, 2641808, ULPK0004
<b>03634</b>	1695/1		3A.144, 3.152.1, 3.152TA,, A3.144, A3.152, A4.236, AD3.152, MOT. PERKINS 3.152	2641406, 2641408, 35273, ULPK0018
<b>03635</b>	1752/1		A4.318, MOT.4.203, 4.203., A4.318.2, APPLICAZIONI VARIE	2641328, 2641333, 2641336, 32518, ULPK0010
<b>03637</b>	1829/1		4.108 MARINE, A4.108, 4.1	2641702, 2641A058
<b>03638</b>	1942/1		1006.6, 1006.60, 1006.60T, 1006.6T, 6.354.4 - T.6.354.4, A6.354.1	2641719, 2641720, 2641729, 2641A070, ULPK0002
<b>03639</b>	1858		11 MOT. 4.248, 4.212, 4.236, 4.243 (C/PO, APPLICAZIONI VARIE	2641338, 2641477, 2641478, 2641720, ULPK0011
<b>03643</b>	1529/1		A4.192, A4.203, A4.300, AD4.203	2641345, 2641346, 2641A065, 32589, ULPK0009
<b>03644</b>	1647/1		F3 CON SIMMS P4442, P4588, P46, MOT.A4.192, MOT.A4.203, MOT.A4.300, MOT.AD4.203, P3 CON SIMMS P4609 (SPAGNA), P3, P3/144, P3/144TA, 3B/152 V	25061501, 25066421, 258862, 2641A077, ULPK0031
<b>03645</b>	1660/1		4/99 A4/107	2641304, 2641305, 2641314, 2641A059, ULPK0017
<b>03646</b>	1687/1		4/99 MARINE, 6.288, 6.305, 6.354, 6.372, A4.248, A6.354.1, AT6.354.1, AT6.354.4	2641372, 2641374, 2641375, 2641377, 2641A064, ULPK0007
<b>03652</b>	2522/5		4.203.2, D4.203	2641722, 2641A054, ULPK0008
<b>03655</b>	1796		V8.510, V8.540, P710	2641469, 2641473 - 2641476, 2641479 - 2641507, 2641481, ULPK0013
<b>03658</b>	1941/5		4.165 (SPAGNA), 4.165 ALLESTIMENTO VOLKSW	2641706, 2641723, 2641809

Art./Ref.	Tipo BCD/Tipo BCD	Brand	Applicazione/Application	Rif. Orig./Orig. Ref.
03659	2563	PERKINS	6.354, 6.354.2, T6.354.3, A6.354.4, AT6.354.4	2641701, 2641710, 2641715, 2641A056, ULKP0022
03660	1796		V8.510, V8.540, P710	2641473 - 2641476, 2641479 - 2641507
14239	1873/5		A4.212, A4.236, 4.238, A4.248, AT3.152.4, AT4.236	2641711, 2641A053, 2641A073, 7990178, ULPK0003
40431	2697		1004 4.40	2641A052, 2641A057, 2641A067, ULPK0005, ULPK0034
03663	1966/5	RUGGERINI	MOT. RD/1, CRD/1, MOT. MOTORIZZATI "FIDO"	652.11, 652.24
03664	1967/5		MD350, MOT MOTORIZZATI "FIDO P.D.I.", MOT. RD/2, CRD/2, RD180, RD952	652.12, 652.25
02107	1910/5	SAME	AURORA 45, CENTURION 75 EXPORT, CORSARO 70, CORSARO 70 SYNCHRO, CORSARO 70F, DELFINO 32, DELFINO 35, FALCON, MINITAURO, MINITAURO 60, MINITAURO 60 C, SATURNO 80, SATURNO 80 SYNCHRO, SIRENETTA, SIRENETTA 32	0 003.8319.6/10, 2.4519.160.0, 2.4519.190.0/10
02110	1930/5		BUFFALO 130, CENTURION 75 EXPORT, CONDOR 55 - CONDOR 55 SYNCHRO, CONDOR C, CORSARO 70 - CORSARO 70 FRUTT, CORSARO 70 SYNCHRO, DRAGO 120, JAGUAR 95, LASER 90-100-110-130-150, LEOPARD 85 - LEOPARD 85 EXPORT, LEOPARD 90, MERCURY 85 - MERCURY 85SP, MINITAURO 60 - MINITAURO 60 C, MINITAURUS 60, PANTHER 90, TAURUS 60 - TAURUS C, TIGER SIX 105 - TIGER 100	2.4519.220.0, 2.4519.230.0/10, 2.4519.290.0
03633	1911/5		BUFFALO 120 - BUFFALO 130, CORSARO 70 - CORSARO 70 FRUTT, CORSARO 70 SYNCHRO, DRAGO 100 - DRAGO 120, LEOPARD 85 - LEOPARD 85 EXPORT, LEOPARD 90, MINITAURO - MINITAURO 60, MINITAURO 60 C, PANTHER 88 - PANTHER 90, PANTHER 95, SATURNO 80 - SATURNO 80 SY, TIGER 50 - TIGER 60, TIGER 70 - TIGER 100	2.4519.120.0, 2.4519.140.0, 2.4519.150.0, 2.4519.180.0, 2.4519.200.0/10
03670	1681/5		TR. ATLANTA 45, TR. CENTAURO 60, LEONE 70	2.4519.130.0
03671	1770/5		ATLANTA 45, CENTAURO 55 - 60, CENTAURO 70 EXPORT, CENTAURO 70 SPECIAL, ITALIA 35, LEONE 70 - 75	2.4519.010.0
03672	1771/5		TR. SAMETTO, SAMITALIA	2.4519.020.0
03674	1991/5 - 2625/1		ANTARES 110, ANTARES 110 II, ANTARES 130, ANTARES 130 II, ARGON 50, ARGON 60, ARGON 70, ASTER 60, ASTER 70, DORADO 60, DORADO 70, EXPLORER 55, EXPLORER 60, EXPLORER 60 II, EXPLORER 60 SPECIAL, EXPLORER 60SPECIAL II, EXPLORER 65, EXPLORER 65 SPECIAL, EXPLORER 70, EXPLORER 70 II, EXPLORER 70 SPECIAL, EXPLORER 70C, EXPLORER 70SPECIAL II, EXPLORER 75, EXPLORER 75 SPECIAL, EXPLORER 80, EXPLORER 80 II, EXPLORER 80 SPECIAL, EXPLORER 80C, EXPLORER 80SPECIAL II, EXPLORER 85, EXPLORER 90, EXPLORER 90 SPECIAL, EXPLORER 90C, EXPLORER 90T II, EXPLORER 95, FRUTTETO 60, FRUTTETO 60 II, FRUTTETO 75 II, FRUTTETO 85 II, GOLDEN 60, GOLDEN 65, GOLDEN 75, GOLDEN 85, MOT. 916.A-W, 065.1600.0, ROWCROP 100, ROWCROP 100.6, ROWCROP 90, RUBIN 120, RUBIN 135, RUBIN 150, RUBIN 160, RUBIN 180, RUBIN 200, SILVER 100.4, SILVER 100.6, SILVER 80, SILVER 90, TITAN 150, TITAN 160, TITAN 165, TITAN 190, VIGNERON 62, VIGNERON 75	2.4519.300.0, 2.4519.310.0
03675	1666/5		SLANZI	DVA 1000
03676	1837/5	DVA 1550, DVA 460		4850.030, 4850.037
03677	1838/5	DVA 1550 S2, 1750S, 2700,, DVA 3600 TB, 2350, DVA 460, 515, 1500, 1750		4850.034, 4850.038, 4850.041, 4850.046, 4850.34 - 4850.38, 4850.41 - 4850.46
03678	1839/5	DVA 700, 790, 920, 1030		4850.036, 4850.039, 4850.042
03675	1666/5	VMMOTORI	MOT. 100 SL, MOT. 104, 106 SU, MOT. 954, 956 SU	1.518.004, 3.518.0002A, 3.518.001
03681	1860/5		MOT. 295 E DERIVATI, MOT. 395 E DERIVATI, MOT. 395 INDUSTRIALE	1.518.0007, 1.518.0009, 1.518.007, 1.518.009, 8.500.128
03682	1861/5		MOT. 102 SU-103 SU, MOT. 104 SU/T, 2, 3, 4 CIL., MOT. 952 SU, 953 SU	1.518.0010, 1.518.003, 1.518.006, 1.518.010, 8.500.121
03683	1920/5		MOT. HR 488, HR 488H, HR 488HT, MOT. HR 588, HR 588H, HR 588 H, MOT. HR494HPT,494HID,494HT	1.518.0015A, 1.518.014, 1.518.015
03684	1921/5		MOT. HR 292, HR 392H, HR 288,	1.518.0016A, 1.518.012, 1.518.016
03685	2521/5		MOT. HR 292, HR 292H, HR 292HT, MOT. HR 294, HR 294H, HR 294HT	1.518.2001A
03691	1958/5		MOT. 298 S.U.	1.518.0018A
03692	1959/5		MOT. 2, 3, 4 CIL. S.U. -SUN	1.518.0017A
03693	1971/5		MOT. HR 388, HR 388H, HR 388HT, MOT. HR 392, HR 392H, HR 392HT, MOT. HR 492 LEYLAND	1.518.0019A

**POMPE NAFTA ALTA QUALITA'**

POMPE GASOIL HAUTE QUALITE'

NAPHTHA PUMP HIGH QUALITY

DIESELKRAFTSTOFFPUMPE HIGH QUALITY

BOMBA NAFTA ALTA CALIDAD



Art./Ref.	Descrizione estesa/Descrizione estesa	Note/Note
<b>00754TOP</b>	Pompa nafta a membrana adattabile al rif. Fiat 4757883 ad alta qualità	Riferimenti originali e applicazioni vedere codice ama 00754/ Original references and applications see ama code 00754
<b>02106TOP</b>	Pompa nafta a membrana adattabile al rif. Massey Ferguson 3637290M91 ad alta qualità	Riferimenti originali e applicazioni vedere codice ama 02106/ Original references and applications see ama code 02106
<b>02107TOP</b>	Pompa nafta a membrana adattabile al rif. Same 0.003.8319.6/10 ad alta qualità	Riferimenti originali e applicazioni vedere codice ama 02107/ Original references and applications see ama code 02107
<b>02108TOP</b>	Pompa nafta a membrana adattabile Perkins 2641311 alta qualità	Riferimenti originali e applicazioni vedere codice ama 02108/ Original references and applications see ama code 02108
<b>02109TOP</b>	Pompa nafta a membrana adattabile Lombardini 6585.030 alta qualità	Riferimenti originali e applicazioni vedere codice ama 02109/ Original references and applications see ama code 02109
<b>02110TOP</b>	Pompa nafta a membrana adattabile al rif. Same 2.4519.230.0/10 ad alta qualità	Riferimenti originali e applicazioni vedere codice ama 02110/ Original references and applications see ama code 02110
<b>02111TOP</b>	Pompa nafta a membrana adattabile Perkins 2641311 alta qualità	Riferimenti originali e applicazioni vedere codice ama 02111/ Original references and applications see ama code 02111/
<b>03612TOP</b>	Pompa nafta a membrana adattabile al rif. Fiat 4757884 ad alta qualità	Riferimenti originali e applicazioni vedere codice ama 03612/ Original references and applications see ama code 03612
<b>03613TOP</b>	Pompa nafta a membrana adattabile al rif. Carraro 30332/30333 ad alta qualità	Riferimenti originali e applicazioni vedere codice ama 03613/ Original references and applications see ama code 03613
<b>03616TOP</b>	Pompa nafta a membrana adattabile Lombardini 6585.031 alta qualità	Riferimenti originali e applicazioni vedere codice ama 03616/ Original references and applications see ama code 03616
<b>03629TOP</b>	Pompa nafta a membrana adattabile a Fiat rif. 9963402 alta qualità	Riferimenti originali e applicazioni vedere codice ama 03629/ Original references and applications see ama code 03629
<b>03630TOP</b>	Pompa nafta a membrana adattabile a Ford rif. 510E350 alta qualità	Riferimenti originali e applicazioni vedere codice ama 03630/ Original references and applications see ama code 03630
<b>03631TOP</b>	Pompa nafta a membrana adattabile a Intermotor rif. 6585.006 alta qualità	Riferimenti originali e applicazioni vedere codice ama 03631/ Original references and applications see ama code 03631
<b>03632TOP</b>	Pompa nafta a membrana adattabile J.Deere AR92777 alta qualità	Riferimenti originali e applicazioni vedere codice ama 03632/ Original references and applications see ama code 03632
<b>03633TOP</b>	Pompa nafta a membrana adattabile Same 2.4519.120.0 alta qualità	Riferimenti originali e applicazioni vedere codice ama 03633/ Original references and applications see ama code 03633
<b>03634TOP</b>	Pompa nafta a membrana adattabile Perkins 2641406 alta qualità	Riferimenti originali e applicazioni vedere codice ama 03634/ Original references and applications see ama code 03634
<b>03635TOP</b>	Pompa nafta a membrana adattabile Perkins 2641328 alta qualità	Riferimenti originali e applicazioni vedere codice ama 03635/ Original references and applications see ama code 03635
<b>03637TOP</b>	Pompa nafta a membrana adattabile Perkins 2641702 alta qualità	Riferimenti originali e applicazioni vedere codice ama 03637/ Original references and applications see ama code 03637
<b>03638TOP</b>	Pompa nafta a membrana adattabile Perkins 2641720 alta qualità	Riferimenti originali e applicazioni vedere codice ama 03638/ Original references and applications see ama code 03638
<b>03639TOP</b>	Pompa nafta a membrana adattabile a Perkins rif. 2641478 alta qualità	Riferimenti originali e applicazioni vedere codice ama 03639/ Original references and applications see ama code 03639
<b>03640TOP</b>	Pompa nafta a membrana adattabile Lombardini 6585.022 alta qualità	Riferimenti originali e applicazioni vedere codice ama 03640/ Original references and applications see ama code 03640
<b>03641TOP</b>	Pompa nafta a membrana adattabile Lombardini 6585.032 alta qualità	Riferimenti originali e applicazioni vedere codice ama 03641/ Original references and applications see ama code 03641
<b>03643TOP</b>	Pompa nafta a membrana adattabile Perkins ULPK0009 alta qualità	Riferimenti originali e applicazioni vedere codice ama 03643/ Original references and applications see ama code 03643
<b>03644TOP</b>	Pompa nafta a membrana adattabile Perkins ULPK0031 alta qualità	Riferimenti originali e applicazioni vedere codice ama 03644/ Original references and applications see ama code 03644
<b>03645TOP</b>	Pompa nafta a membrana adattabile Massey F: 35205 alta qualità	Riferimenti originali e applicazioni vedere codice ama 03645/ Original references and applications see ama code 03645

Art./Ref.	Descrizione estesa/Descrizione estesa	Note/Note
<b>03646TOP</b>	Pompa nafta a membrana adattabile Perkins ULPK0007 alta qualità	Riferimenti originali e applicazioni vedere codice ama 03646/ Original references and applications see ama code 03646
<b>03652TOP</b>	Pompa nafta a membrana adattabile Perkins 2641722 alta qualità	Riferimenti originali e applicazioni vedere codice ama 03652/ Original references and applications see ama code 03652
<b>03655TOP</b>	Pompa nafta a membrana adattabile a Perkins rif. ULPK0013 alta qualità	Riferimenti originali e applicazioni vedere codice ama 03655/ Original references and applications see ama code 03655
<b>03658TOP</b>	Pompa nafta a membrana adattabile Perkins 2641809 alta qualità	Riferimenti originali e applicazioni vedere codice ama 03658/ Original references and applications see ama code 03658
<b>03659TOP</b>	Pompa nafta a membrana adattabile Perkins 2641710 alta qualità	Riferimenti originali e applicazioni vedere codice ama 03659/ Original references and applications see ama code 03659
<b>03663TOP</b>	Pompa nafta a membrana adattabile Lombardini 652.11 alta qualità	Riferimenti originali e applicazioni vedere codice ama 03663/ Original references and applications see ama code 03663
<b>03664TOP</b>	Pompa nafta a membrana adattabile Ruggerini 652.12 alta qualità	Riferimenti originali e applicazioni vedere codice ama 03664/ Original references and applications see ama code 03664
<b>03670TOP</b>	Pompa nafta a membrana adattabile Same 2.4519.130.0 alta qualità	Riferimenti originali e applicazioni vedere codice ama 03670/ Original references and applications see ama code 03670
<b>03671TOP</b>	Pompa nafta a membrana adattabile Same 2.4519.010.0 alta qualità	Riferimenti originali e applicazioni vedere codice ama 03671/ Original references and applications see ama code 03671
<b>03672TOP</b>	Pompa nafta a membrana adattabile Same 2.4519.020.0 alta qualità	Riferimenti originali e applicazioni vedere codice ama 03672/ Original references and applications see ama code 03672
<b>03674TOP</b>	Pompa nafta a membrana adattabile a rif. Same 2.4519.310.0 ad alta qualità	Riferimenti originali e applicazioni vedere codice ama 03674/ Original references and applications see ama code 03674
<b>03675TOP</b>	Pompa nafta a membrana adattabile VM 3.518.00002A alta qualità	Riferimenti originali e applicazioni vedere codice ama 03675/ Original references and applications see ama code 03675
<b>03676TOP</b>	Pompa nafta a membrana adattabile al rif. Slanzi 4850.037 ad alta qualità	Riferimenti originali e applicazioni vedere codice ama 03676/ Original references and applications see ama code 03676
<b>03677TOP</b>	Pompa nafta a membrana adattabile Slanzi 4850.041 alta qualità	Riferimenti originali e applicazioni vedere codice ama 03677/ Original references and applications see ama code 03677
<b>03678TOP</b>	Pompa nafta a membrana adattabile Slanzi 4850.039 alta qualità	Riferimenti originali e applicazioni vedere codice ama 03678/ Original references and applications see ama code 03678
<b>03680TOP</b>	Pompa nafta a membrana adattabile al rif. VM 1.518.2005A alta qualità	Riferimenti originali e applicazioni vedere codice ama 03680/ Original references and applications see ama code 03680
<b>03681TOP</b>	Pompa nafta a membrana adattabile VM 1.518.0009 alta qualità	Riferimenti originali e applicazioni vedere codice ama 03681/ Original references and applications see ama code 03681
<b>03682TOP</b>	Pompa nafta a membrana adattabile VM 1.518.0010 alta qualità	Riferimenti originali e applicazioni vedere codice ama 03682/ Original references and applications see ama code 03682
<b>03683TOP</b>	Pompa nafta a membrana adattabile VM 1.518.0015a alta qualità	Riferimenti originali e applicazioni vedere codice ama 03683/ Original references and applications see ama code 03683
<b>03684TOP</b>	Pompa nafta a membrana adattabile VM 1.518.0016A alta qualità	Riferimenti originali e applicazioni vedere codice ama 03684/ Original references and applications see ama code 03684
<b>03685TOP</b>	Pompa nafta a membrana adattabile VM 1.5182001A alta qualità	Riferimenti originali e applicazioni vedere codice ama 03685/ Original references and applications see ama code 03685
<b>03691TOP</b>	Pompa nafta a membrana adattabile VM 1.518.0018A alta qualità	Riferimenti originali e applicazioni vedere codice ama 03691/ Original references and applications see ama code 03691
<b>03692TOP</b>	Pompa nafta a membrana adattabile VM 1.518.0017A alta qualità	Riferimenti originali e applicazioni vedere codice ama 03692/ Original references and applications see ama code 03692
<b>03693TOP</b>	Pompa nafta a membrana adattabile VM 1.518.0019A alta qualità	Riferimenti originali e applicazioni vedere codice ama 03693/ Original references and applications see ama code 03693/
<b>14239TOP</b>	Pompa nafta a membrana adattabile Perkins 2641A053 alta qualità	Riferimenti originali e applicazioni vedere codice ama 14239/ Original references and applications see ama code 14239
<b>40431TOP</b>	Pompa nafta a membrana adattabile al rif. Massey Ferguson 4222106M91 ad alta qualità	Riferimenti originali e applicazioni vedere codice ama 40431/ Original references and applications see ama code 40431

**VASCHETTA ALIMENTAZIONE CARBURANTE GRUPPO FILTRANTE ADATTABILE**

RESERVOIR ALIMENTATION GASOIL GROUPE FILTRANT ADAPTABLE  
 FUEL INJECTION TANK FOR FILTERING GROUP ADAPTABLE  
 KRAFTSTOF SPEISUNGS BECHER FUER FILTER TYP CAV PASSEND ZU  
 SUMIDERO ALIMENTACION CARBURANTE PARA FILTRO ADAPTABLE



Art./Ref.	Brand	Applicazione/Application	Rif. Orig./Orig. Ref.
<b>03064</b>	<b>FIAT</b>	1000, 1100, 1300, 1355, 1380, 1580, 160.90-160.90 DT, 650, 655, 700, 750, 800, 850, 900	705599, 75204389, 766875, 772163, 79047888
	<b>FORD</b>	8630	772163
	<b>LAVERDA</b>	3300AL-3400-3400R, 3500-3500R-3550-3550R, 3550AL - MX240 - MX240R, 3650-3650R-3750-3750R	766875, 772163
	<b>NEW HOLLAND</b>	TK160-55	772163

**TAPPO SERBATOIO CARBURANTE ADATTABILE**

BUCHON RESERVOIR CARBURANT ADAPTABLE  
 FUEL TANK PLUG ADAPTABLE TO  
 KRAFTSTOFFTANK PFROPFEN PASSEND ZU  
 TAPON DEPOSITO CARBURANTE ADAPTABLE

Art./Ref.	Brand	Applicazione/Application	Rif. Orig./Orig. Ref.	Immagine/Image
<b>08485</b>		1000, 215, 315, 415, 446, 465, 466, 55.46-55.46 DT, 55.56-55.56 DT, 55.66-55.66 DT, 55.66S-55.66S DT, 565, 566, 60.46-60.46 DT, 60.56-60.56 DT, 60.66-60.66 DT, 60.66S-60.66S DT, 615, 65.46-65.46 DT, 65.56-65.56 DT, 65.66-65.66 DT, 65.66S-65.66S DT, 665, 666, 70.56-70.56 DT, 70.66-70.66 DT, 70.66S-70.66S DT, 715, 765, 766, 80.66-80.66 DT, 80.66S-80.66S DT, 850	5123779, 5139618, 588974, 592145	
<b>08486</b>		300, 440, 450, 455, 480, 500, 505, 540, 605, 640, 650, 655, 750, 805	4062251, 4062252, 4117122, 44901657, 4988782, 5118532	
<b>08488</b>	<b>FIAT</b>	100, 110, 115, 1180, 1280, 130, 1300, 1380, 140, 1580, 160, 180, 1880, 446, 565, 570, 580, 665, 670, 680, 72.86, 765, 780, 855, 880, 955, 980, SERIE 66, SERIE 76, SERIE 86, SERIE 88, SERIE 90, SERIE 93, SERIE 94	4181662, 5105346, 700706814, 9960827, 5105346	
<b>15108</b>		211, 250, 300, 311C, 355C, 411, 411C, 450, 480, 500, 540, 550, 555C, 605C, 640, 640.DT, 650, 655C, 750	4117122, 563366	
<b>27571</b>		115.90-115.90 DT, 130.90-130.90 DT, 140.90-140.90 DT, 160.90-160.90 DT, 180.90-180.90 DT, 35.66-35.66 DT	5115440, 5115440	

08488	FORD	4030-4230-4430	5105346	
17187		2000,2310,2600,2610,2810,2910, 3000,3055,3600,3610,3900,3910, 4100,4110 SENZA CABINA, 5000,5600,5610,5900,6600,6610, 7000,7600,7610 SENZA CABINA	83961128, E7NN9030AA	
71433	LANDINI	10000, 13000, 6550, 7550, 8550 (DAL 22500086), 8550 (FINO A 22500085), CINGOLATI: C4830, CINGOLATI: C5830, CINGOLATI: C6830, CINGOLATI: C7830, CINGOLATI: C8860, CINGOLATI: CF4830, CINGOLATI: CF5030, CINGOLATI: CF5830, CINGOLATI: CF6030, CINGOLATI: CF6060, CINGOLATI: CF6830, FRUTTETI 530 F/L/V: 7530F PRIM, FRUTTETI 530 F/L/V: 5530F PRIMA, FRUTTETI 530 F/L/V: 6530F PRIMA, FRUTTETI 530 F/L/V: 8530F PRIMA	3300019M91	
11276	MASSEY FERGUSON	1100 A6.354, 1200 A6.354.1, 135,148,230,240 AD3.152, 155,158,165 AD4.203, 165 A4.212, 168,175,265,275,565, A4.236, 178,185,188,285, A4.248, 250,550 AD3.152, 285,290,590,960 A4.248, 293,595,698 A4.138, 35 A3.152, 399 A6.354.4, 575,675 A4.236, 65,765 A4.192, 65,765 A4.203, 698T A4.236	16098042M91, 1698042M91, 828583M91	
08488	NEW HOLLAND	SERIE TK 55 - 65 - 75 - 85	5105346	
27571		SERIE TK, T4020-T4030-T4040-T4050, TN55, TN55D, TN55S, TN65, TN65D, TN65S, TN70, TN70D, TN70S, TN75, TN75D, TN75S	5115440	

**RUBINETTO CARBURANTE ADATTABILE**

ROBINET CARBURANT ADAPTABLE

FUEL FIAT TAP ADAPTABLE

PASSEND ZU KRÄFTSTOFFHAHN

LLAVE CARBURANTE ADAPTABLE



Art./Ref.	Brand	Applicazione/Application	Rif. Orig./Orig. Ref.
03480	FIAT	1300, 311C, 312, 350, 355C, 411, 411C, 420, 450, 455C, 480, 500, 540, 550, 555c, 605C, 615, 640, 650, 655C	4970881, 4998702, 5109270, 551464, 576071, 591659
15461	NEW HOLLAND	TK160-55	4966618

**RACCORDO AD OCCHIELLO E VITE FORATA**
*RACCORD BANJO ET VIS*
*EYED CONNECTION*
*AUGEANSCHLUSS*
*RACOR EN OJO Y TORNILLO TALADRADO*

Art./Ref.	Diametro Occhiello/ Diametro Occhiello	Diametro Tubo/ Diametro Tubo	Note/Note
<b>06740</b>	12	6	Vite forata art. <b>01805</b> filet o M12x1,5/Driller screw ref. 01805 thread M12x1,5
<b>06741</b>	12	8	Vite forata art. <b>01805</b> filet o M12x1,5/Driller screw ref. 01805 thread M12x1,5
<b>06742</b>	12	10	Vite forata art. <b>01805</b> filet o M12x1,5/Driller screw ref. 01805 thread M12x1,5
<b>06743</b>	14	8	Vite forata art. <b>01831</b> filet o M14x1,5/Driller screw ref. 01831 thread M14x1,5
<b>06744</b>	14	10	Vite forata art. <b>01831</b> filet o M14x1,5/Driller screw ref. 01831 thread M14x1,5
<b>06745</b>	16	10	Vite forata art. <b>01814</b> filet o M16x1,5/Driller screw ref. 01814 thread M16x1,5

**TUBO SPECIALE IN GOMMA PER MISCELA**
*TUYAU SPECIAL POUR MELANGE CARBURANT*
*SPECIAL RUBBER HOSE FOR MIXTURE*
*BESONDERER GUMMIROHR FÜR BENZIN*
*TUBO ESPECIAL EN GOMA PARA MEZCLA*

Art./Ref.	Diametro Tubo/Diametro Tubo	Note/Note
<b>F07188</b>	Ø 3,2 x 6,4	Nero/Black
<b>00740</b>	Ø 4 x 7	Trasparente/Transparent
<b>00723</b>	Ø 5 x 9	Trasparente/Transparent
<b>F07189</b>	Ø 4,8 x 8,4	Nero/Black
<b>00719</b>	Ø 7 x 12	Trasparente/Transparent



**TUBO IN GOMMA PER CARBURANTE**

TUBE EN CAOUTCHOUC POUR CARBURANT  
 RUBBER HOSE FOR FUELS  
 ROHR MIT GUMMI FÜR KRAFTSTOFF  
 TUBO DE CAUCHO PARA CARBURANTE



**Note:** # Tubo idoneo per adduzione di olii minerali, diesel e benzine ecologiche e compatibile con fluidi a cordo alle norme EN 590: 2010. Utilizzabile a una temperatura da -20°C a +80°C. Struttura: A) Sottostrato liscio in gomma nera NBR resistente ai prodotti petroliferi con contenuto aromatico non superiore al 40%; B) Rinforzo con inserzioni di fili sintetici ad alta resistenza; C) Copertura in gomma nera nitrilica antistatica resistente all'abrasione, ai carburanti, agli olii e agli agenti atmosferici; D) Superficie liscia estrusa. Pressione esercizio: 10 bar; pressione scoppio 30 bar.

**Notes:** # Hose suitable for loading of mineral oils, diesel and unleaded fuel, and compatible with fluids according to EN 590: 2010. Temperature range: -20°C a +80°C. Construction: A) Tube black, smooth NBR rubber, petroleum products up to 40% aromatic content resistance; B) Reinforcement with high strength synthetic textile yarn; C) Cover black nitrilic antistatic rubber, abrasion, fuels, oils and weathering resistant; D) Surface smooth extruded. Working pressure 10 bar; burst pressure 30 bar.

Art./Ref.	Diametro Interno/ Diametro Interno	Diametro Esterno/ Diametro Esterno	Pollici/Pollici	Pressione d'esercizio BAR/ Working pressure BAR	Pressione scoppio BAR/ Burst pressure BAR
89161	5 mm	12 mm	3/16"	10 bar	30 bar
02158	6 mm	13 mm	1/4"		
02159	8 mm	15 mm	5/16"		
02160	10 mm	17 mm	3/8"		
89162	13 mm	20 mm	1/2"		
89163	15 mm	23 mm	19/32"		
89164	19 mm	27 mm	3/4"		
89165	25 mm	35 mm	1"		

**BOCCOLE IN ALLUMINIO PER TUBO TRECCIATO**

DOUILLES ALUMINIUM POUR TUBE TRESSE  
 ALLUMINIUM BUSHES FOR BRAIDED HOSE  
 ALUMINIUM BÜCHSEN FÜR ROHR MIT TEXTILFLECHTE  
 CASQUILLO DE ALUMINIO PARA TUBO CON TRENZA

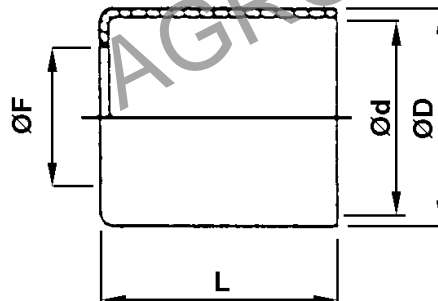

Art./Ref.	Diametro interno mm/ Inside diameter mm	Diametro esterno mm/ Outside diameter mm	Larghezza mm/ Width mm
06688	13	15	21
06689	15	17	23
06690	17.5	19	23

**COPERCHIO PER FILTRI CAV 296 796 CON ADESCATORE**

CAPOT POUR FILTRE CAV 296 ET 796 AVEC AMORCEUR  
 CAP FOR CAV 296 796 TYPE FILTERS WITH PRIMER  
 DECKEL FÜR CAV-FILTER 296 UND 796 MIT ANSAUGER  
 TAPA POR FILTROS CAV 296 796 CON CEBADOR



Art./Ref.	Note/Note
<b>06966</b>	Coperchio per filtri av 296 e 796 con adescatore/Locking Device Cover for CAV fil er 296 and 796

**BICCHIERINO IN VETRO**

GOBELET EN VERRE  
 GLASS SUPPORT  
 GLASBECHER  
 VASO DE VIDRIO



Art./Ref.	Note/Note
<b>07032</b>	Bicchierino in vetro/Glass supportL

**VASCA DECANTATORE IN VETRO ADATTABILE A**

CUVE DECANTEUR EN VITRE ADAPTABLE  
 GLASS BOWL ADAPTABLE TO  
 KRAFTSTOFFSPEISUNGSBECKER AUS GLAS PASSEND ZU  
 CUBETA DE DECANTACION IN VIDRIO ADAPTABLE



Art./Ref.	Brand	Rif. Orig./Orig. Ref.
<b>02721</b>	<b>FIAT</b>	9918123
	<b>MASSEY FERGUSON</b>	1039071M1
	<b>PERKINS</b>	26560111, 26560601

**SUPPORTO FILTRO COMPLETO FILETTO M 14 X 1,5**

SUPPORT FILTRE COMPLET FILET M14X1,5  
 COMPLETE FILTER SUPPORT 14 X 1,5 THREAD  
 FILTERHALTER KOMPLETT GEWINDE M14X1,5  
 SOPORTE FILTRO COMPLETO ROSCA M14X1,5



Art./Ref.	Note/Note
<b>06967</b>	Con adescatore da destra a sinistra/With right-left primer
<b>06968</b>	Con adescatore da sinistra a destra/With left-right primer

**SUPPORTINO FILTRO COMPLETO PER POMPA ALIMENTAZIONE**

SUPPORT FILTRE COMPLET POUR POMPE ALIMENTATION  
 COMPLETE FILTER SUPPORT FOR FUEL PUMP  
 FILTERHALTER KOMPLETT FÜR PUMPE  
 SOPORTE FILTRO COMPLETO PARA BOMBA ALIMENTACIÓN



Art./Ref.	Note/Note	Brand	Rif. Orig./Orig. Ref.
<b>07018</b>	Supporto filtro completo/Complete filter support	<b>BOSCH</b>	1457434000
<b>07019</b>	Filtro x Pompa Alimentazione 07018/Fuel pump filter for 07018	<b>FIAT</b>	705603, 772160, 9930048

**VALVOLE DI NON RITORNO**

CLAPET ANTI-RETOUR  
 ONE WAY VALVES  
 EINWEG-VENTILE  
 VALVULAS DE NO VUELTA



Art./Ref.	Diametro tubo mm/Hose diameter mm	Note/Note
<b>07098</b>	8	Valvola con filtro/ Valve with filter
<b>07099</b>	10	

**VALVOLE DI NON RITORNO**

CLAPET ANTI-RETOUR  
ONE WAY VALVES  
EINWEG-VENTILE  
VALVULAS DE NO VUELTA



Art./Ref.	Note/Note
07095	Valvola non ritorno M 14 x 1,5 /14 x 1.5 M One way valve
07096	Valvola non ritorno M14x1,5 invertita /M14x1.5 Inverted one way valve

**VALVOLA DI NON RITORNO Ø 6 MM. - Ø 8 MM.**

CLAPET ANTI-RETOUR Ø 6 MM. - Ø 8 MM.  
ONE WAY VALVE Ø 6 MM. - Ø 8 MM.  
EINWEG-VENTIL Ø 6 MM. - Ø 8 MM.  
VALVULAS DE NO VUELTA Ø 6 MM. - Ø 8 MM.



Art./Ref.	Diametro tubo mm/ Hose diameter mm	Note/Note
07097	Ø 6 - Ø 8	Valvola non ritorno Ø 6 mm. - Ø 8 mm. Ø 6 mm. - Ø 8 mm One way valve

**VALVOLE DI NON RITORNO**

CLAPET ANTI-RETOUR  
ONE WAY VALVES  
EINWEG-VENTILE  
VALVULAS DE NO VUELTA



Art./Ref.	Note/Note	Diametro tubo mm/ Hose diameter mm
07090	Valvola non ritorno tipo "AC"/ "AC" One way valve	8
07091		10

**VALVOLA PER POMPETTA ALIMENTAZIONE IN BACHELITE ROSSA LAPPATA**

CLAPET POUR POMPE ALIMENTATION EN BAKELITE ROUGE RODÉ  
FUEL PUMP VALVE - IN RED LAPPED BAKELITE  
VENTIL FÜR BRENNSTOFFPUMPE AUS ROTEM BAKELIT  
VALVULA PARA BOMBA ALIMENTACIÓN IN BAQUELITA ROJA ALISADA



Art./Ref.	Note/Note	Brand	Rif. Orig./Orig. Ref.
07089	Valvola x pompa alimentazione /Feed pump valve	BOSCH	2443123021

**VALVOLA DI SOVRAPRESSIONE ADATTABILE RIF. 1417413012 BOSCH**

CLAPET DE SURPRESSION ADAPTABLE RIF. 1417413012 BOSCH  
OVER PRESSURE VALVE ADAPTABLE TO RIF. 1417413012 BOSCH  
ÜBERDRUCKVENTILE PASSEND ZU RIF. 1417413012 BOSCH  
VALVULAS RESPIRADERAS PARA BOMBA SUMERGIDA ADAPTABLE RIF. 1417413012 BOSCH



Art./Ref.	Note/Note	Brand	Rif. Orig./Orig. Ref.
07088	Valvola sovrappressione Ø 12/Ø 12 Over-pressure valve	BOSCH	1417413012
07087	Valvola sovrappressione Ø 14/Ø 14 Over-pressure valve	FIAT	758065

**VALVOLE DI SFIATO PER POMPA SOMMERSA**

CLAPET REFOULEMENT POUR POMPE SUBMERGÉ  
BREATHING VALVE FOR SUBMERGED PUMP  
ENTLUFTUNGSVENTIL FÜR TAUCHPUMPE  
VALVULAS RESPIRADERAS PARA BOMBA SUMERGIDA



Art./Ref.	Note/Note	Filetto/Thread
07092	Valvola sfi to x pompa M6x1/ Fuel pump bleed M6x1	M 6 X 1

**VITE DI SPURGO M6 ADATTABILE BOSCH**

VIS DE CURAGE M6 ADAPTABLE BOSCH  
M6 EXHAUST SCREW ADAPTABLE BOSCH  
ENTLUFTUNGSSCHRAUBE M6 PASSEND ZU BOSCH  
TORNILLO DE PURGA M6 ADAPTABLE BOSCH



Art./Ref.	Filetto/Thread	Note/Note
07007	M6x1	Vite spurgo M6 adattabile Bosch/ Bleed screw M6 type Bosch

**TAPPI DI SPURGO**

BOUCHONS DE PURGE  
BLOWDOWN SCREWS  
ENTLUFTUNGSSCHRAUBEN  
TAPAS DE PURGA



Art./Ref.	Note/Note	Filetto/Thread
07003	Tappo spurgo M 12x1,5/M12x1,5/ M12x1,5 Drain plug	M 12X1,5
06969	Tappo spurgo Cav 1/2" UNF /Drain plug Cav 1/2" UNF	1/2" UNF

**SPURGO CORTO REGOLATORE ADATTABILE CAV**

CURAGE COURT REGULATEUR ADAPTABLE POUR CAV  
 ADJUSTER SHORT BLOWDOWN SCREW ADAPTABLE TO CAV  
 ENTLUFTUNGSSCHRAUBE KURZ REGULIERBAR PASSEND ZU CAV  
 PURGA CORTA REGULADORA ADAPTABEL CAV



Art./Ref.	Note/Note	Brand	Rif. Orig./Orig. Ref.
07005	Spurgo corto regolatore /Adjuster short blowdown screw	CAV	7123-351B

**SPURGO LUNGO CORPO POMPA ROTATIVA ADATTABILE CAV**

CURAGE LONG CORP POMPE ROTATIVE ADAPTABLE CAV  
 ROTATION ADAPTABLE CAV PUMP LONG EXHAUST SCREW  
 ENTLUFTUNGSSCHRAUBE LANG FÜR ROTATIONSPUMPE PASSEND ZU CAV  
 PURGA LARGA CUERPO BOMBA ROTATIVA ADAPTABEL CAV



Art./Ref.	Brand	Rif. Orig./Orig. Ref.
07004	CAV	7123-352B

**BULLONI FORATI PER INIETTORI**

BOULONS PERCÉS POUR INJECTEUR  
 DRILLED SCREWS FOR INJECTORS  
 SCHRAUBEN GEBOHRT FÜR INJEKTIONSGERÄTE  
 PERNO HORADOS PARA INYECTORES



Art./Ref.	Filetto/Thread	Note/Note
07001	M8x1	Bullone forato M8x1/M8x1 Bleed Screw
07000	M8x1,25	Bullone forato M8x1,25/ M8x1,25 Perforated bleed screw

**RACCORDI ENTRATA NAFTA**

RACCORDS ENTRÉE NAFTA  
 FUEL INLET FITTINGS  
 BRENNSTOFFEINLASS-VERSCHRAUBUNGEN  
 RACORES ENTRADA NAFTA



Art./Ref.	Diametro Int/ Diametro Int	Note/Note
06974	12-14	Raccordo entrata 12-14/12-14 Inlet fittin

**RACCORDI PORTAGOMMA**

RACCORDS PORTE TUYAU  
 FITTINGS  
 VENTIL VERSCHRAUBUNGEN  
 RACORES LLEVAGOMA



Art./Ref.	Filetto/Thread	Diametro tubo mm/Hose diameter mm
07039	Raccordo M 12 x 1,5	8

**RACCORDO FILTRO ADATTABILE CAV**

RACCORD FILTRE ADAPTABLE CAV  
 ADAPTABLE CAV FILTER FITTING  
 PASSEND ZU CAV FILTER VERSCHRAUBUNG  
 RACORES FILTRO ADAPTABLE CAV



Art./Ref.	Note/Note
06970	Raccordo filt o Cav/Cav Filter fittin

**RACCORDI AD OCCHIELLO A DUE VIE**

RACCORDS 2 VOIES  
 2 WAY-EYE FITTINGS  
 ZWEGE-VERSCHRAUBUNG  
 RACORES A OJAL A 2 VIAS



Art./Ref.	Diametro Occhiello/ Diametro Occhiello	Diametro tubo mm/ Hose diameter mm	Note/Note
07033	6	4	Raccordo occhiello a due vie Ø6 /2-way Ø 6 eye fittin

**ADESCATORE CORTO ADATTABILE**

AMORCEUR COURT ADAPTABLE  
SHORT PRIMER ADAPTABLE TO  
ANSAUGER KURZ PASSEND  
ASPIRADOR CORTO ADAPTABLE



Art./Ref.	Filettatura/Thread	Brand	Applicazione/Application	Rif. Orig./Orig. Ref.
14946	M 16x1,5	BCD CORONA	-	9411
		BOSCH	-	2447222000/016
		FIAT	120C, 140.90DT, 160.90DT, 180.90DT, 70C	746189, 772102, 774417, 79020913, 79032352, 79047878, 9968879, 9970182
		LAVERDA	L627	9968879
		NEW HOLLAND	9630, 9640, 9645, FX28, FX300, FX375, FX450, TF78, TX68	9968879

**ADESCATORE LUNGO ADATTABILE BOSCH**

AMORCEUR LONG ADAPTABLE POUR BOSCH  
LONG PRIMER ADAPTABLE TO BOSCH  
ANSAUGER LONG PASSEND ZU BOSCH  
ASPIRADOR LARGO ADAPTABLE BOSCH



Art./Ref.	Filetto/Thread	Note/Note	Brand	Rif. Orig./Orig. Ref.
16668	M 16x1,5	Adescatore in alluminio/Primer aluminum type	BOSCH	2447222001

**ADESCATORE MAGGIORATO M16X1,5 ADATTABILE BCD CORONA**

AMORCEUR MAJORE M16X1,5 ADAPTABLE BCD CORONA  
OVERSIZED PRIMER M16X1,5 ADAPTABLE TO BCD CORONA  
ANSAUGER LANG M16X1,5 PASSEND ZU BCD CORONA  
ASPIRADOR M16X1,5 ADAPTABLE BCD CORONA



Art./Ref.	Filetto/Thread	Note/Note	Brand	Rif. Orig./Orig. Ref.
18225	M 16x1,5	Foro Ø 25 tipo universale/Ø 25 Universal Hole	BCD CORONA	D9350 5422 001
			FIAT	771388

**RUBINETTI PER SERBATOI BENZINA E PETROLIO ADATTABILI**

ROBNETS POUR RESERVOIR ESSENCE ET PETROLE ADAPTABLE

TAPS FOR FUEL AND PETROL TANKS ADAPTABLE

KUGELHAHN FÜR TANKS BENZIN UND ERDOL PASSEND ZU

LLAVE PARA DEPOSITO GASOLINA Y PRTROLEO ADAPTABLE

Posizione / Position 1

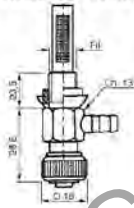

Posizione / Position 2



Posizione / Position 3



Posizione / Position 4

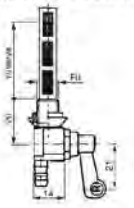

Posizione / Position 5

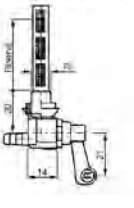

Posizione / Position 6

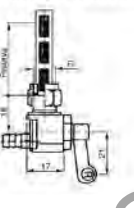

Posizione / Position 7

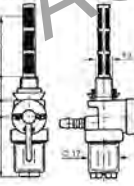

Posizione / Position 8

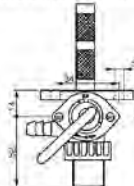

Posizione / Position 9

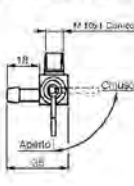

Posizione / Position 10

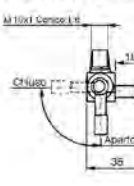

Posizione / Position 11

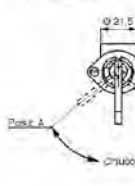

Posizione / Position 12



Art./Ref.	Pos.	Attacco Serbatoio/ Attacco Serbatoio	Attacco Inferiore Codolo/ Attacco Inferiore Codolo	Riserva Carburante/ Riserva Carburante	Brand
05089	8	Flangia interasse 34 mm	Ø 8 mm.	No	ACME
05080	1	Filetto M10x1	Ø 6 mm.	No	BENASSI
05081	2	Filetto M10x1	Ø 6 mm.	No	
05083	4	Filetto M10x1	Ø 6 mm.	Si	
05084	5	Filetto M10x1	Ø 6 mm.	Si	
05086	6	Filetto M10x1	Ø 6 mm.	Si	
05081	2	Filetto M10x1	Ø 6 mm.	No	BRUMITAL
05082	3	Filetto M10x1	Ø 6 mm.	No	
05083	4	Filetto M10x1	Ø 6 mm.	Si	
05084	5	Filetto M10x1	Ø 6 mm.	Si	
05082	3	Filetto M10x1	Ø 6 mm.	No	CARPI
05082	3	Filetto M10x1	Ø 6 mm.	No	CIFARELLI
05081	2	Filetto M10x1	Ø 6 mm.	No	CM MOTORI
05082	3	Filetto M10x1	Ø 6 mm.	No	EFCO
05082	3	Filetto M10x1	Ø 6 mm.	No	FOX
05090	9	Filetto M10x1 conico	Ø 9 mm.	No	INTERMOTOR
05091	10	Filetto M10x1 conico	1 via Ø 6 mm.	No	
05092	10	Filetto M10x1 conico	2 vie Ø 6 mm.	No	
05093	11	Fissaggio con bullone 6 MA	Ø 9 mm.	No	
05094	12	Fissaggio con bullone 6 MA	Ø 9 mm.	No	
05090	9	Filetto M10x1 conico - Rif. Orig. 7755.055	Ø 9 mm.	No	LOMBARDINI
05091	10	Filetto M10x1 conico Rif. Orig. 7755.055	1 via Ø 6 mm.	No	
05092	10	Filetto M10x1 conico Rif. Orig. 7755.055	2 vie Ø 6 mm.	No	
05093	11	Fissaggio con bullone 6 MA Rif. Orig. 7755.055	Ø 9 mm.	No	
05094	12	Fissaggio con bullone 6 MA Rif. Orig. 7755.055	Ø 9 mm.	No	
05080	1	Filetto M10x1	Ø 6 mm.	No	MAB
05085	7	Filetto M12x1	Ø 6 mm.	Si	
05086	6	Filetto M10x1	Ø 6 mm.	Si	
05080	1	Filetto M10x1	Ø 6 mm.	No	MINARELLI
05081	2	Filetto M10x1	Ø 6 mm.	No	
05086	7	Filetto M10x1	Ø 6 mm.	Si	
05080	1	Filetto M10x1	Ø 6 mm.	No	MIRA

**CARBURATORI ORIGINALI DELL'ORTO ADATTABILI**

CARBURATEURS ORIGINE DELL'ORTO ADAPTABLE

ORIGINAL DELL'ORTO CARBURATORS ADAPTABLE

DELL'ORTO ORIGINALVERGASER PASSEND ZU

CARBURADORES ORIGINALES DELL'ORTO ADAPTABLE



Art./Ref.	Brand	Note/Note	Applicazione/Application	Rif. Orig./Orig. Ref.
05959	ACME	N° regolazione 7449/Adjustment n. 7449	MOTORE/ENGINE A220 B	155138
05960		N° regolazione 7706/Adjustment n. 7706	MOTORE IND-IND ENGINE AT 330	155211 - 155160
05962	CM MOTORI	N° regolazione 1719/Adjustment n. 1719	MOTORE-ENGINE CM 46	SHA 14.12 L
05963		N° regolazione 1732/Adjustment n. 1732	MOT STAZ-STATIONARY CM80-CM90	SHA 14.14 L
05964	COTIEMME	N° regolazione 7378/Adjustment n. 7378	MOT-ENGINE CA180L/B-CA148P/LP	FHCD 20.16
05959	DELL'ORTO	N° regolazione 7449/Adjustment n. 7449	-	FHC 20.16 A
05960		N° regolazione 7706/Adjustment n. 7706	-	FVCA 24.19
05962		N° regolazione 1719/Adjustment n. 1719	-	SHA 14.12 L
05963		N° regolazione 1732/Adjustment n. 1732	-	SHA 14.14 L
05964		N° regolazione 7378/Adjustment n. 7378	-	FHCD 20.16
05967		N° regolazione 7721/Adjustment n. 7721	-	FVCA 24.19
05968		N° regolazione 7376/Adjustment n. 7376	-	FHCD 20.16A
05969		N° regolazione 7396/Adjustment n. 7396	-	FHCD 20.16A
05971		N° regolazione 7358/Adjustment n. 7358	-	FHCD 20.16
06980		N° regolazione 7720/Adjustment n. 7720	-	FVCA 22.17
06982		N° regolazione 7725/Adjustment n. 7725	-	FVCA 24.19
05967		INTERMOTOR	N° regolazione 7721/Adjustment n. 7721	MOT INDUST-INDUST ENG IM350, MOT INDUST-INDUST ENG IM359
06980	N° regolazione 7720/Adjustment n. 7720		MOTORE-ENGINE IM250, MOTORE-ENGINE IM300	2151.063 - 2151.084 - 2151.237
06982	N° regolazione 7725/Adjustment n. 7725		MOTORE-ENGINE IM352, MOTORE-ENGINE IM359	2151.248
06980	LOMBARDINI	N° regolazione 7720/Adjustment n. 7720	MOTORE-ENGINE LA250, MOTORE-ENGINE LA300	2151.063 - 2151.084 - 2151.237
05968	MINARELLI	N° regolazione 7376/Adjustment n. 7376	MOTORE-ENGINE I90 - I125	15.7008.9 - FHCD 20.16 A
05969		N° regolazione 7396/Adjustment n. 7396	MOTORE-ENGINE I90/3 MOTOZAPPA	FHCD 20.16 A
05971	MORINI	N° regolazione 7358/Adjustment n. 7358	MOTORE AGRIC/ENGINE C100 -CZ7	FHCD 20.16

**CARBURATORI ORIGINALI BING ADATTABILE**

CARBURATEURS ORIGINE BING ADAPTABLE

ORIGINAL BING CARBURATORS ADAPTABLE

BING-ORIGINALVERGASER PASSEND ZU

CARBURADORES ORIGINALES BING ADAPTABLE PARA MOTORES JLO BING



Art./Ref.	Brand	Applicazione/Application
<b>05949</b>	<b>JLO</b>	L152
<b>05950</b>		L197

**INIETTORI ADATTABILI**

INJECTEURS ADAPTABLE

INJECTORS ADAPTABLE TO

EINSPRITZDÜSE PASSEND ZU

INYECTORES ADAPTABLE

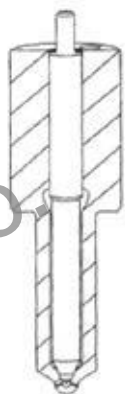

Art./Ref.	Brand	Applicazione/Application	Rif. Orig./Orig. Ref.
<b>88102</b>	<b>CASE</b>	1270,1370, MOT.504BDT,4158DT	4760843, 772019
<b>35026</b>		100-55,100-90,110-90DT,110-90, 100-90DT,45-66,45-66DT,45-66S, 45-66S DT,45-76V,50-66,50-66DT, 50-66S,50-66S DT,50-86V, 50-86V DT,50-86S V,50-86S V DT, 55-46,55-46DT,55-56,55-56DT, 55-65F,55-65M,55-65V,55-66, 55-66DT,55-66DT LP,55-66F, 55-66F DT,55-66LP,55-66V,, 55-66V DT,55-66S,55-66S DT, 55-75F,55-75M,55-75V,55-76F, 55-76F DT,55-76V,55-76V DT, 55-85F,55-85M,55-85V,55-88, 55-88DT,56-66S,56-66S DT, 60-46,60-46DT,60-56DT,65-46, 65-46DT,65-56,65-56DT,65-66, 65-66DT,65-66S,65-66S DT, 65-88,65-88DT,65-90,65-90DT, 65-93,65-93DT,65-94,65-94DT, 70-56,70-56DT,70-65,70-65M, 70-66,70-66DT,70-66F,70-66F DT, 70-66LP,70-66LP DT,70-66V, 70-66S DT HC,70-75,70-75M, 70-66S,70-66S HC,70-66S DT, 70-76F,70-76F DT,70-76LP, 70-76LP DT,70-76V,70-86V, 70-86V DT,70-86S V,70-86S V DT, 70-88,70-88DT,70-90,70-90DT, 72-85,72-85M,72-86F,72-86F DT, 72-86LP,72-86LP DT,72-93,, 72-93DT,72-94,72-94DT	4791689, 4792443
<b>35616</b>	<b>FIAT</b>	55.86F-55.86F DT, 55.86S V-55.86S V DT, 55.86V-55.86V DT, 60-56 (1/89->.....), 60-65 (9/84->12/88), 60-65M(9/84->12/88), 60-65V(9/84->12/88), 60-66 (6/84->12/92), 60-66DT(6/84->12/92), 60-66F (1/84->12/90), 60-66FDT(6/84->12/92), 60-66LP(1/84->12/90), 60-66LPDT(1/84->12/90), 60-66S(12/92->.....), 60-66SDT(12/92->.....), 60-75 (1/89->12/92), 60-75M(1/89->12/92), 60-75V(1/89->12/92), 60-88 (4/90->12/92), 60-88DT(4/90->12/92), 60-90 (1/84->12/90), 60-90DT(1/84->12/90), 60-93 (1/93->12/95), 60-93DT(1/93->12/95), 60-94 (1/93->12/95), 60-94DT(1/93->12/95), 60.76F-60.76F DT, 60.86 F-60.86F DT, 60.86 V-60.86 V DT, 60.88-60.88 DT, 62.86 F-62.86F DT, 80-65 (9/84->12/88), 80-66 (6/84->12/92), 80-66DT(6/84->12/92), 80-75 (1/89->12/92), 80-88 (4/90->12/92), 80-88DT(4/90->12/92), 80-90 (1/84->12/92), 80-90DT(1/84->12/92), 82-85 (9/92->.....), 82-86 (3/92->.....), 82-86FDT(3/92->.....), 82-86LP(3/92->.....), 82-86LPDT(3/92->.....), 82-93 (1/93->12/95), 82-93DT(1/93->12/95), 82-94DT(1/93->12/95), 85-55 (9/84->12/88), 88-85 (9/92->.....), 88-93 (1/93->12/95), 88-93DT(1/93->12/95), 88-94 (1/93->12/95), 88-94DT(1/93->12/95), F110-F110 DT, F120-F120 DT	4817267, 4824171, 99431240



Art./Ref.	Brand	Applicazione/Application	Rif. Orig./Orig. Ref.
42950		F100-F100 DT, F130-F130 DT, F140-F140 DT	98419045, 98435369, 98471321
88101	FIAT	100,1000S,1000DT,1000 SUPER, 1000 SUPER,1180,1180DT,1280, 1280DT,1300,1300DT,1300S,, 1300SDT,1355C,1380,1380DT, 1580,1580DT,1880,1880DT, 200R,211R,215C,221,250,250DT, 255,300,300DT,300J,311,311R, 312,312R,315,321,331,332,350, 350DT,351,352C,355,366,400, 400DT,411,411R, 412,412R,415, 415DT,420,420DT,421,431,440, 440DT,441,446,446DT,450,450DT, 451,455C,460,460DT,465,466, 466DT,470,470DT,474,474DT,480, 480DT,500,500DT,505C,540,540DT, 540S,550,565C,566,570,580,600, 605C,640,655C,666,670,680,766, 780,855C,880-5,900,980,995C, 8365.05, MOT.605D,8045.02,OM CO 3/80, MOT.8035.01,8065.01,OM CO 2D, MOT.8035.02D,8065.24, MOT.8035.04,8365.25,OM CO 3/70, MOT.8045.01,OM CP 3/100, MOT.8065.04,OM CN 3,8025.02, MOT.OM CO 1D/45,8055.04, MOT.OM CO 3/60, MOT.OM CO 3/75,615D,8065.02, MOT.OM CO 3D/130,8045.04, OM CO 1D,OM CP 3,8035.02	4758260, 767404, 770945, 9967223
88102		1000 SUPER,1000DT,1000N,1000S, 1180,1180DT,1280,1280DT,1380, 1380DT,466,466DT,480,480DT, 540DT,540S,566,570,580,605C, 640,666,670,680,766,780,880-5, 980, MOT.8035.02,8055.04,8045.02, MOT.8065.04,8035.02D,8045.04, MOT.8065.24,8035.04,8065.02	4760843, 772019
35026		3435,3935,4135,4230,4635,4835, 5635,6635,7635,	4792443, 99474914
35616		3830 (8035.06), 3830 - 4030, 4010S, 4030 (8035.05), 4430 (8045.05), 4635 (9/95->12/98), 4835 (9/95->12/98), 5635 (9/95->12/98), 6635 (8045.05), 7635 (9/95->12/98)	4817267, 99431240
41861		3000, 3055, 3100, 3120, 3150, 3300, 7100, 7200, 8700, 9700, TW10 - 20 - 30	81821327, C9NN9E527B
41862	FORD	231, 233, 2600, 2600N, 2600R, 2600V, 333, 335, 3600, 3600N, 3600NQ, 3600R, 3600V, 3900, 420, 4600, 4600NO, 4600O, 4600SU, 515, 531, 532, 535, 5600, 5700, 6600, 6600C, 6600O, 6700, 7600, 7600C, 7700	83900064, D4NN9E527C
41864		231, 233, 2600, 2600N, 2600R, 2600V, 333, 335, 3600, 3600N, 3600NQ, 3600R, 3600V, 3900, 420, 4600, 4600NO, 4600O, 4600SU, 515, 531, 532, 535, 5600, 5610, 5700, 6410, 6600, 6600C, 6600O, 6610, 6610O, 6700, 6710, 6810, 7410, 7610, 7600C, 7610, 7610O, 7700, 7710, 7810, 7810O, 7910, 8210, 8530, 8630-8730-8830, TW5 - 15 - 25 - 35	83919155, D9NN9E527AA
42950		4635-4835-5635-6635-7635	98435369
88101		DEXTA,MAJOR,POWER MAJOR, MOTORE 220, SUPER DEXTA,SUPER MAJOR	767404, 770945
42950	IVECO	8045.25K,8065.25, 8065.05,8065.25S,8065.06	98435369
88101		-	4758260, 9967223
40476		4000 SPECIAL,5000DT,6000, 4530V, 4560V, 5500, 5530F, 5530L, 5530V, 5560F, 5560L, 5560V, 5830, 5840, 5860, 5870, 6860, 6880, 7860, 7880, 8860, 9060, 9080, 9880, ADVANTAGE 55F, ADVANTAGE 55FP, ADVANTAGE 55GE, ADVANTAGE 55GT, ADVANTAGE 55GTP, ADVANTAGE 55L, ADVANTAGE 55LP, ADVANTAGE 65F, ADVANTAGE 65FP, ADVANTAGE 65GE, ADVANTAGE 65GT, ADVANTAGE 65GTP, ADVANTAGE 65L, ADVANTAGE 65LP, ADVANTAGE 75F,75FP,75GE,75GT, ADVANTAGE 85F,85FP,85GT,85GTP, ADVANTAGE 85L,85LP,85GT, ATLANTIS 100,75,80,90, ATLAS 100,75,80,90, BLIZZARD 50,65,75,85,95, C4500,C4830,C5500,C5830, CF4830,CF5030,CF5830, GHIBLI 100,105,85,95, GLOBALFARM 100,105,90,95, GLOBUS 50,55, LANDPOWER 115,125,130,145,160, LANDPOWER 165,185, LEGEND 105,115,130,145,165, LEGEND 115NG,120NG,130NG,140NG, LEGEND 125NG TDI,130 BLU, LEGEND 135NG TDI,145NG TDI, LEGEND 160 BLU, 165NG TDI, LEGEND 160NG,180NG, LEGEND 185NG TDI, MYTHOS 105,115, MYTHOS 90,100, POWERFARM 75,85,95,105, REX 90GE, TREKKER 100C,70C,70F,70L,80C, TREKKER 105C,105F,105M,85C, TREKKER 50F,55F, TREKKER 80F,80L,90C,90F,90L, TREKKER 85F,85M,95C,95F,95M, TREKKER C75,C85,C95, TREKKER CF55,CF65,CF85, VIGNETO 55V,60V,65V,75V, VIGNETO 75V,85V, VISION 80,90,100, VISION 85,95,105	1447252M1
40477	LANDINI	3000R,3000RV,4000SPECIAL, 5000DT,5000R,5000R,5000R-N, 5000R-S,5000SPECIAL,6000, 6000DT,6000 SPECIAL,7000R, C5000,C6000	1853019M91
40479		4560V,5560F/L,5860, 5500,6500, 5530F/L/V,5830, 5840, 5870, ADVANTAGE 55F/FP/GE/GT/GTP/L, BLIZZARD 50, C5500,C5830,CF5030,CF5830, GLOBUS 50, TREKKER CF55,55F, VIGNETI 55V	1446896M1
40480		6060,6060F,6060L,6060V, 6070, ADVANTAGE 60F,60FP,60GE,60GT, ADVANTAGE 60GTP,60L,60LP, BLIZZARD 60, CF6030,CF6060, TREKKER CF60, VIGNETO 60V	3637320M1
40484		8860, 9060, 9080, 9880, ADVANTAGE CAB: L95GT, ADVANTAGE L95GT, ATLANTIS 85, ATLAS: 85, BLIZZARD: 95, SERIE 60NEW: 8860(MOTORE BLU), TREKKER: C95	3637319M1
40485		8530F/L,8500,8560F/L,8860, 8550, 8830, 8870,8880, ADVANTAGE 85F/FP/GE/GT/GTP/L/V, BLIZZARD 85, C7800,C7830,C8860, TREKKER C85,CF85,85F	1446703M1
40489		9500, C10500, LARGE 10000,10000S	883258M91
40493		LARGE 16000,16500,9550	1447658M1

Art./Ref.	Brand	Applicazione/Application	Rif. Orig./Orig. Ref.
35026	LAVERDA	3400,3400R	4792443
40476	MASSEY FERGUSON	-	1447252M1
40477		135 (->203993D), 135V(->203993D), 765, IND.3165,3303,3305,356,50	1853019M91
40479		145,148,152,154,233,244,250,253,254,255,2205,342,350,353,354,3210,550, INDUST.20C,20D,20E,30B,30E,40	1446896M1, 3639738M1, 4222905M1
40480		352,355,360, 363,363LX,363S, 364AP,364AQ,364CF,364F,364FP, 40E INDUSTRIAL	3637320M1
40484		1004T,1007,390T,393TLX,394TAQ, 3070,4225(->01/01/99), 396CT,397T,398,3065,3065S, 4225HV(->01/01/99), 4235 (->01/01/99), 4235HV(->01/01/99), 698T,6110, INDUSTRIAL 60HX,60HX-T	3637319M1
40485		178,185,188,194,194C,194F,194S, 285,293,294,294C,294S, IND.50EX,50HX,50HX-S,60H,60H-S	1446703M1
40489		-	883258M91
40493		2720,2725, 3650, AT6.354.4	1447658M1
35026	NEW HOLLAND	L60,L65,L75,L85,L95,, TL70,TL80,TL90,TL100	4792443, 99474914
35616		L60, L65, L75, L85, L95, TL100, TL70, TL80, TL90	4817267, 4824171, 99431240
42950		L60-65-75-85-95, TL65-70-80-90-100	98435369, 98471321
40476	PERKINS	1004.40T, 1004.42, 1006.6, 1006.60T, 1006.6T, 1104C-44, 1104C-44T, 1106C-E60TA, 903-27, A3.144, A3.152, A4.203, A4.236, A4.248, A4.41, AD3.152, AD4.203, AT4.236	26460257, 2646607, 31990, 35504
40477		AD3.152,AD4.203	26461311, 2646673, 2646676
40479		AD3.152,A4.236	2646825, 2646C620
40480		AD3.152, AT3.152.4, AT3.152	2645K603, 26461307
40484		AT4.236,A4.41,1004.42	2645C617, 2645K602
40485		A4.248,A4.236	2645C611, 2646678, 2646690
40489		A6.354, A6.354.1, A6.354.4, AD3.152	883258M91
40492		AT6.354.1	2646698
40493		AT6.354.4,A6.354.4	2645A603
88102	UNIVERSAL	1010,340,530,533,640,643,703	4760843, 772019

# 1.7.20 Sistema di raffreddamento

Cooling system



**ama**

**Ricambi & accessori per macchine agricole**  
SPARE PARTS & ACCESSORIES FOR AGRICULTURAL MACHINE

Tutti gli articoli della presente sezione, prodotti da AMA SPA e/o da terzi per conto di AMA, sono adattabili ("non originali") alle marche indicate ai sensi di quanto previsto dal REG. CE n. 1400/2002. I diritti sui marchi citati appartengono ai legittimi proprietari e il loro uso ha l'esclusiva finalità di consentire all'utilizzatore la comparazione dei diversi prodotti.  
All items of this section, manufactured by AMA SPA and/or any third party on behalf of AMA, are adaptable ("non-original") to the brands listed under the provisions of the REG. CE n. 1400/2002. The rights on the trademarks belong to their respective owners and their usage is only aimed to allow the user to compare different products.

**RADIATORI IN RAME ADATTABILI**

RADIATEUR CUIVRE ADAPTABLE  
RADIATOR COPPER ADAPTABLE  
KÜHLER COPPER PASSEND ZU  
RADIADOR DE COBRE ADAPTABLE



**Note:** Tutti i modelli sono forniti completi di tappo

**Notes:** All models supplied with plug

Art./Ref.	Brand	Applicazione/Application	Rif. Orig./Orig. Ref.
38738	CASE	5120, 5130, 5140, 5150, 5220, 5230, 5240, 5250	104753A1
09591	FIAT	411, 451C	576976
09592		650, 715, 750, FL6	44089044, 4950225, 4951831
09593		55.56-55.56 DT, 55.66S-55.66S DT, 566, 570V-F-DT, 60.56-60.56 DT, 60.66S-60.66S DT, 640, 65.46-65.46 DT, 65.56-65.56 DT, 65.66S-65.66S DT, 666, 70.56-70.56 DT, 70.66S-70.66S DT, 766, 80.66S-80.66S DT	4956666, 4981428, 4986634, 5104821, 5118305, 5139027, 5153481
09594		440 V/DT, 450, 455C, 480, 505C, 540-S DT, 550, 600-DT, 605C	4952983, 4973345, 5002561
16060		45.66-45.66 DT, 45.66S-45.66S DT, 50.66-50.66 DT, 50.66S-50.66S DT, 55.66LP-55.66L DT, 56.66S-56.66S DT, 60.66F-60.66F DT, 60.66LP-60.66LP DT, 60.76F-60.76F DT, 62.86F-62.86F DT	5128854, 5156033
16344		1180, 1280, 1380	5103110, 5109294
16576		55.90-55.90 DT, 60.90-60.90 DT, 65.90-65.90 DT, 680, 70.90-70.90 DT, 780, 80.90-80.90 DT, 85.90-85.90 DT, 880, 90.90-90.90 DT	4997175, 5143883, 5156059
16581		311, 312	576975
16583		315, 415, 415R	588156, 595568
85538		60-75 V, 60-85 V, SERIE 76 F - V, SERIE 86 F - V	44908541

09593	FORD	3010S, 4010S, 5010S	5153481
16060		3435-3935-4135, 4030	5156033
17092		2000, 2100, 2110, 2120, 2150, 2300, 2310, 2600, 2610, 2810, 2910, 3000, 3055, 3100, 3110, 3120, 3150, 3300, 3310, 3330, 3400, 3500, 3550, 3600, 3610, 3900, 3910, 4000, 4100, 4110, 4140, 4200, 4330, 4340, 4400, 4410, 4500, 4600, 4610, 5000, 5100, 5200, 5340, 5600, 5700, 6600, 7000, 7100, 7200, 7600, 7700	81875325, 87687383, E0558005MD15, E0NN8005MD15M
17093		231-233, 2600-2600N-2600R-2600V, 333-335, 3600-3600N-3600NO-3600R-3600V, 3900-4000-4100-4110-4140-420, 4200-4330-4340-4400-4410-4500, 4600-4600NO-4600O-4600SU, 5100-515-5200-531-532-5340-535, 5600-5700-6600-6600C-6600O, 6700-7000-7100-7200, 7600-7600C-7700	81817280
42068		5110, 5610, 6410, 6610-66100, 6710, 6810, 7410, 7610-76100, 7710	83993346, E0NN8005GC15M
85538		4230 - 4430	44908541
85539		4635, 4835, 5635, 6635, 7635	5169275

16060	NEW HOLLAND	TK55.65 F - V - M, TK55.75 F - V - M	5128854, 5156033
85539		L60 - L65 - L75 - L85 - L95, TK100A, TK65F - TK65V, TK70FA - TK70VA, TK75F - TK75FA, TK75M - TK75MA, TK75V - TK75VA, TK76 - TK76M, TK80A - TK80MA, TK85 - TK85M, TK90A - TK90MA, TK95M, TL70 - TL80 - TL90 - TL100	5169275, S5169275

Art./Ref.	Brand	Applicazione/Application	Rif. Orig./Orig. Ref.	Note/Note
09595	LANDINI	5500, 5830, 5840, 6500, 6550, 6830, 6840, 7500, 7550, 7830, 8300, 8550, 8830, CINGOLATI : C6830(FINO A 320B01, CINGOLATI: C4500, CINGOLATI: C4830, CINGOLATI: C5500, CINGOLATI: C5830, CINGOLATI: C6500, CINGOLATI: C7800	1824627M91, 1824627M93	5830(2WD fino a 122P01504), ( 4WD fino 222R01910);6550 (fino a D00534);6830(fino 12101299);7830( fino a 12000401);8830(fino 123H000319)
71301		5830, 5860, 5870, 6030, 6040, 6060, 6070, 6550, 6830, 6860, 6870, 6880, 7830, 7860, 7870, 7880, 8830, 8860, 8870, 8880, BLIZZARD: 50, BLIZZARD: 60, BLIZZARD: 65, BLIZZARD: 75, BLIZZARD: 85, CINGOLATI: C6830, CINGOLATI: C7830, CINGOLATI: C8860, CINGOLATI: CF4830, CINGOLATI: CF5030, CINGOLATI: CF5830, CINGOLATI: CF6030, CINGOLATI: CF6060, CINGOLATI: CF6830, FRUTTETI 530 F/L/V: 8530F, NEW SERIE 60: 5860, TREKKER C: C75, TREKKER C: C85, TREKKER CF: CF65, TREKKER CF: CF75, TREKKER CF: CF85, TREKKER NEW: 70C/F/L, TREKKER NEW: 80C/F/L	3666234M91	



Art./Ref.	Brand	Applicazione/Application	Rif. Orig./Orig. Ref.
09595	MASSEY FERGUSON	134C - 154 - 154C - 174 - 174C, 194 - 194C, 233 - 234C - 234S - 253, 254 - 254C - 254S - 273, 274 - 274C - 274S - 274SK, 283 - 284 - 284S, 293 - 294 - 294S	1824627M91, 1824627M93
11258		165, 50	885411M93, 897357M92, 897358M4
11288		133, 135, 135V, 140, 145, 145S, 145V, 148, 152, 152F, 152S, 152V, 40	1660498M91, 1660499M92, 1871721M91, 885856M94, 962071M93
11289		20B - 20E - 20F, 230, 240, 250, 30E - 30H - 40E	1672862M91, 1680547M91, 1680547M92
40561		35	894319M92
40571		FE35	894357M92
40578		265, 275, 285, 565	1876606M4, 1876607M1

**RADIATORI IN ALLUMINIO**

RADIATEURS EN ALUMINIUM  
ALUMINUM RADIATORS  
ALUMINIUM-KUHLER  
RADIADORES DE ALUMINIO

**Note:** Tutti i modelli sono forniti completi di tappo

**Notes:** All models supplied with plug

Art./Ref.	Note/Note
09593A	NEW ALUMINUM - TOP QUALITY - RIF ORIGINALI E APPLICAZIONI VEDERE CODICE 09593
09594A	NEW ALUMINUM - TOP QUALITY - RIF ORIGINALI E APPLICAZIONI VEDERE CODICE 09594
16576A	NEW ALUMINUM - TOP QUALITY - RIF ORIGINALI E APPLICAZIONI VEDERE CODICE 16576



**MANICOTTI IN BARRE DA 1 MT.**

MANCHONS EN BARRE DE 1 MT.  
HOSE 1 MT. LONG  
SCHLAUCHEN - LAENGE 1 MT.  
MANGOS EN BARRAS DE 1 MT.



**Note:** Con inserti in tessuto. Temperatura d'impiego da -40° a +120°

**Notes:** With tissue inserts. Usage temperature from -40° to +120°

Art./Ref.	A mm	B mm	Bar/Bar	Note/Note
52669	16	24	5	Tubo radiatore/Radiator hose
52672	20	27	5	Tubo radiatore/Radiator hose
52675	22	29	5	Tubo radiatore/Radiator hose
52678	25	32	5	Tubo radiatore/Radiator hose
52683	28	36	5	Tubo radiatore/Radiator hose
52686	32	40	5	Tubo radiatore/Radiator hose
52688	35	43	5	Tubo radiatore/Radiator hose
52691	38	48	5	Tubo radiatore/Radiator hose
52694	45	55	5	Tubo radiatore/Radiator hose

**MANICOTTI SUPERIORI ADATTABILI**

MANCHONS ADAPTABLE

HOSE ADAPTABLE

KUEHLERSCHLAHUELSE PASSEND ZU

MANGOS ADAPTABLE



Art./Ref.	Brand	Applicazione/Application	Rif. Orig./Orig. Ref.
08571	FIAT	100.90-100.90 DT, 110.90-110.90 DT, 55.90-55.90 DT, 580, 60.90-60.90 DT, 65.90-65.90 DT, 65.94-65.94 DT, 680, 70.90-70.90 DT, 72.94-72.94 DT, 780, 80.90-80.90 DT, 82.94-82.94 DT, 85.90-85.90 DT, 88.94-88.94 DT, 880-5, 90.90-90.90 DT, 980	4997263, 5111527
08572		446 - 446 DT, 465, 466 - 466 DT, 55.46-55.46 DT, 55.56-55.56 DT, 55.66-55.66 DT, 566, 570, 60.46-60.46 DT, 60.56-60.56 DT, 60.65M - 60.65V, 60.66-60.66 DT, 65.46-65.46 DT, 65.56-65.56 DT, 65.66-65.66 DT, 666, 670, 70.56-70.56 DT, 70.66-70.66 DT, 766, 80.66-80.66 DT	5104825
08632		450, 450 DT, 480, 480 DT, 500, 500 DT, 540, 540 DT, 540S, 550, 600, 640	4950088
12982		115.90-115.90 DT, 1180, 1180 DT, 1280, 1280 DT, 130.90-130.90 DT, 1380, 1380 DT, 140.90-140.90 DT, 980	5107001
35052		250, 300, 350, 420	597704
36410		55-66, 55-76, 55-86 (V+F), 60/86 (V+F)	44901505, 9955610
21820	FORD	2000, 2100, 2110, 2120, 2150, 2300, 231 - 233 - 333 - 335 - 420, 2310, 2600, 2610, 2810, 2910, 3000, 3100, 3120, 3150, 3190, 3300, 3400, 3500, 3600, 3610, 3900, 3910, 4000, 4100, 4110, 4130, 4140, 4190, 4200, 4400, 4450, 4500, 4550, 4600, 4610, 5000, 5100, 5110, 5190, 5200, 5550, 5600, 5610, 5900, 6550, 6600, 6610 (= >07.87) CON ARIA COND. 6610 SENZA ARIA COND., 7000, 7100, 7550, 7600, 7610	81805628, 83907414, C5NN8260A, C5NN8260B, D5NN8260D
42147		5110 (>08.87), 5610 (>08.87), 5610S, 5900 (>08.87), 6410, 6610 (>08.87), 6610S, 6810, 6810S, 7010, 7410, 7610 (>08.87), 7610S	83959443, E6NN8260CA
42148		5610, 5700, 5900, 6700, 6710 (<07.87 NO AC), 7700, 7710 (<07.87 NO AC)	83905554, D5NN8260C
42153		6710, 7700, 7710 (<07.87 AC)	83905570, D4NN8260C
42155		7710 C/ARIA COND (08.87=>), 7710 C/ARIA COND (>08.87)	83959442, E6NN8260BA
42158		7840, 8240, 8340	81862935, F0NN8260DA
42159		7910, 8210	83929875, E0NN8260AA
42162		8530, 8630, 8730, 8830, TW5-15-25-35	83933451, 83934898, E2N-N8333AA, E3NN8333AA
42163		8700, 9700	83914013, D8NN8260CA
42167		8530 - 8630 - 8730 - 8830, TW30-TW35, TW5-TW10-TW15-TW20-TW25	83913315, 83918850, 83934898, D8NN8260BA, D8NN8260BB
42955	3230, 3430, 3930, 4130, 4630, 4830, 5030	82015118	
38292	JOHN DEERE	2250, 2355, 2450, 2450F, 2555CS, 2555TSS, 2650, 2650CS, 2650F, 2650N, 2650TSS, 2755, 2850, 2855N	L56296
38293		2940, 2950, 3040, 3140, 3150, 3340, 3640, 3640S, 4040, 4040S	L32456
71014	LANDINI	VIGNETI REX CAB TIER 2: 75V, VIGNETI REX CAB TIER 2: 85V	3678913M1
40540	MASSEY FERGUSON	3085, 3095, 3115, 3120, 3120T	3582179M1
40596		35	890195M1
40598		133, 135, 135V, 140, 145, 145S, 145V, 148, 152, 152F, 152S, 152V, 20B-20D-20E-20F-30E-30H-40-40E, 230, 235, 240, 245, 253, 255, 263, 263T	1869514M1, 897455M1
40602		340, 342, 350, 352, 355, 360	1696559M1
40605		TEA20, TED20, TEF20, TEH20	1568
40607		FE35	827496M1
40610		65, 765, 865	827930M1
40612		165, 50	194738M1, 898064M1
40614		165, 168 - 168F - 168S, 175S, 178, 185 - 188, 265, 275, 275E, 285, 290, 30D - 50 - 50B, 375E, 575 - 575 - 590	885564M1, 899144M1
40616		175, 178	194739M1, 894793M1
40619		362	3611652M1
40623		399	1695563M1
40628		675, 690	1681509M1
40629		1004, 298, 698	1669805M1
40633		699	1692871M1
40639		3050, 3060, 3065	3382976M1
40643		3080, 3090	3387747M1

**MANICOTTI INTERMEDI ADATTABILI**

MANCHONS ADAPTABLE  
HOSE ADAPTABLE  
KUEHLERSCHLAHUELSE PASSEND ZU  
MANGOS ADAPTABLE

Art./Ref.	Brand	Applicazione/Application	Rif. Orig./Orig. Ref.
<b>08626</b>	<b>CASE</b>	AVJ55 - AVJ60 - AVJ70, JX100U-JX1060C-JX1060V, JX1070C-JX1070N-JX1070V, JX1075C-JX1075N-JX1075V, JX1095N-JX1095V, JX55-JX60-JX65-JX70, JX70U-JX75-JX80-JX80U, JX85-JX90-JX90U-JX95, VJ60 - VJ70 - VJ80	596152
<b>08579</b>		750, 850, 880	8819913
<b>08626</b>	<b>FIAT</b>	100.90-100.90DT, 1000, 110.90-110.90 DT, 115.90-115.90 DT, 1180, 130.90-130.90 DT, 140.90-140.90 DT, 35.66-35.66DT, 45.66-45.66DT, 45.66S-45.66S DT, 450, 450R, 450V, 455C, 480, 480V, 50.66-50.66DT, 50.66S-50.66S DT, 500, 500S, 505C, 540, 540V, 55.46-55.46DT, 55.56-55.56DT, 55.66-55.66DT, 55.66LP-55.66LP DT, 55.66S-55.66S DT, 55.88-55.88DT, 55.90-55.90DT, 550, 555C, 56.66S-56.66S DT, 580, 60.46-60.46 DT, 60.56-60.56 DT, 60.66-60.66 DT, 60.66F-60.66F DT, 60.66LP-60.66LP DT, 60.66S-60.66S DT, 60.76F-60.76F DT, 60.88-60.88 DT, 60.90-60.90DT, 60.93-60.93DT, 60.94-60.94 DT, 600, 605C, 62.86F-62.86F DT, 640, 65.46-65.46DT, 65.56-65.56DT, 65.66-65.66DT, 65.66S-65.66S DT, 65.88-65.88DT, 65.90-65.90DT, 65.93-65.93 DT, 65.94-65.94 DT, 680, 70.56-70.56DT, 70.66-70.66DT, 70.66F-70.66F DT, 70.66LP-70.66LP DT, 70.66S-70.66S DT, 70.66V-70.66V DT, 70.76F-70.76F DT, 70.76LP-70.76LP DT, 70.76V-70.76V DT, 70.88-70.88DT, 70.90-70.90DT, 72.86F-72.86F DT, 72.86LP-72.86LP DT, 72.93-72.93DT, 72.94-72.94DT, 780, 80.66-80.66DT, 80.66F-80.66F DT, 80.66S-80.66S DT, 80.76F-80.76F DT, 80.88-80.88DT, 80.90-80.90DT, 82.86F-82.86F DT, 82.86LP-82.86LP DT, 82.93-82.93DT, 82.94-82.94DT, 85.90-85.90DT, 855C, 88.93-88.93DT, 88.94-88.94DT, 880/5, 90.90-90.90DT, 955C, 980, F100-F100DT, F110-F110DT, F115-F115DT, F120-F120DT, F130-F130DT, F140-F140DT	5096235, 596152, 77902285
<b>40584</b>	<b>FORD</b>	DEXTA - SUPER DEXTA	81716947
<b>40585</b>		DEXTA, SUPER DEXTA	81716946
<b>42073</b>		DEXTA, SUPER DEXTA	81718098, 81718101, 957E83333A, 957E83333B
<b>42131</b>		MAJOR, POWER MAJOR, SUPER MAJOR	81718097, E1ADKN8333
<b>40584</b>	<b>LANDINI</b>	4000 SPECIAL, 4530V-5530F-5530L-5530V, 4560V-5560F-5560L-5560V, 5000DT, 5500, 5830-6030-6030F-6030L-6030V, 5840 - 6040, 5860-6060-6060F-6060L-6060V, 5870 - 6070, ADVANTAGE 55F-55FP-55GE, ADVANTAGE 55GT-55GTP-55L-55LP, ADVANTAGE 55V-60F-60GT-60L, BLIZZARD: 50, BLIZZARD: 60, CINGOLATI: CF5830, CINGOLATI: C4500, CINGOLATI: C4830, CINGOLATI: C5000, CINGOLATI: C5500, CINGOLATI: C5830, CINGOLATI: CF4830, CINGOLATI: CF5030, CINGOLATI: CF6030, REX 60FP-60GE-60GTP-60LP, TREKKER: CF55, TREKKER: CF60	U5MH0006
<b>40585</b>		4000SPECIAL - 5000DT, 4530V-5530F-5530L-5530V, 4560V-5560F-5560L-5560V, 5500, 5830-6030-6030F-6030L-6030V, 5840 - 6040, 5860-6060-6060F-6060L-6060V, 5870 - 6070, ADVANTAGE 55F-55FP-55GE-55GT, ADVANTAGE 55GTP-55L-55LP, ADVANTAGE 60F-60GT-60L, BLIZZARD: 50, BLIZZARD: 60, CINGOLATI: CF5830, CINGOLATI: CF6030, CINGOLATI: C4500, CINGOLATI: C4830, CINGOLATI: C5000, CINGOLATI: C5500, CINGOLATI: C5830, CINGOLATI: CF4830, CINGOLATI: CF5030, GLOBUS: 50, GLOBUS: 55, REX 60FP-60GE-60GTP-60LP, REX 60V - 65V, REX CAB E FOOT STEP: 60, TREKKER: CF55, TREKKER: CF60, VIGNETI CAB E FOOT STEP: 55V, VIGNETI REX CAB: 60V	U5MH0001
<b>40589</b>		6000-6000SPECIAL-7000SPECIAL, 6500, 6505, C6000	U5MH0011, U5MH0065
<b>40590</b>		6000, 6000/DT, 6000/S, 6000R, 7000R, C6000	U5MH0018
<b>40584</b>		<b>MASSEY FERGUSON</b>	133, 134C, 134V, 135, 135V, 140, 145, 145S, 145V, 148, 150, 152, 152F, 152S, 152V, 154, 154C, 154F, 154S, 154V, 164TF, 164TS, 164TV, 20, 203, 205, 20B, 20C, 20D, 20E, 20F, 2135, 2203, 2205, 230, 233, 234C, 234CF, 234S, 235, 240, 244CF, 245, 24T, 250, 250X, 253, 254, 254C, 254CF, 254S, 263T, 264T, 264TFC, 264TS, 30B, 30E, 30H, 3210FP, 3210GE, 3210SP, 333, 334V, 340, 342, 35, 350, 352, 353, 353LX, 353S, 354AP, 354AQ, 354F, 354FP, 354FQ, 354GE, 354S, 354SP, 354SQ, 354V, 354VQ, 355, 356CF, 360, 40, 40E, 415, 550
<b>40585</b>	133, 134C, 134V, 135V, 140, 145, 145S, 145V, 150, 152, 152F, 152S, 152V, 154, 154C, 154F, 154S, 154V, 20, 203, 205, 20B, 20C, 20D, 20E, 20F, 2135, 2203, 2205, 233, 234C, 234CF, 234S, 235, 244CF, 245, 24T, 250X, 253, 254, 254C, 254CF, 254S, 255, 340, 342, 350, 30B, 30E, 30H, 3210FP - 3210GE - 3210SP, 333, 334V, 35, 135, 148, 230, 240, 250, 353, 353LX, 353S, 354AP, 354AQ, 354F, 354FP, 354FQ, 354GE, 354S, 354SP, 354SQ, 354V, 354VQ, 356CF, 40, 415, 550		732443M1, 747939M91, U5MH0001
<b>40588</b>	702, 835, FE35		826199M1
<b>40589</b>	155, 158, 158F, 158S, 158V, 165, 260, 30, 302, 304, 3165, 3303, 3305, 356, 40B, 50, 560, 65, 765, 865		3637426M91, 4223777M91, U5MH0011, U5MH0065
<b>40590</b>	158F - 158S - 158V, 30 - 302 - 304 - 3165 - 3303, 3305 - 356 - 40B - 50, 560, 65, 765, 155, 158, 165, 260, 865		731174M1, 747941M91, U5MH0018

Art./Ref.	Brand	Applicazione/Application	Rif. Orig./Orig. Ref.
40592	MASSEY FERGUSON	164TF - 164TS - 164TV, 253 - 263T, 264T - 264TCF - 264TS, 352 - 355 - 360 - 363, 364AP-364AQ-364CF-364F-364FP, 364FQ-364GE-364S-364SP-364SQ, 364V - 364VQ - 366CF, 40E	3637574M91, U5MH0017
40593		1004T, 265, 292, 365, 375, 390, 390T, 398, 425, 460, 610 TURBO - 620, 698T	3637572M1, 3638251M91, U5MH0052
40594		1004T, 292, 365, 375, 390, 390T, 398, 698T, 460, 5275 - 5285 - 5290, 5340, 610 TURBO - 620	3637573M91, U5MH0047
40595		1014 - 1024 - 1114, 2620, 2625, 2640, 2645, 2675, 2680, 2685, 2705, 2720, 2725, 3080, 3090, 3610, 3630, 3650, 399, 699	3637427M91, U5MH0028
08626	NEW HOLLAND	L60, L65, L75, L85, L95, SERIE TL, TK100.55, TK100A, TK55, TK55.65 F, TK55.65 M, TK55.65 V, TK55.75 F, TK55.75 M, TK55.75 V, TK55.85 F, TK55.85 M, TK55.85 V, TK60.65, TK60.65 M, TK60.65 V, TK60.75 F, TK60.75 M, TK60.75 V, TK60.85 F, TK60.85 V, TK60A, TK62.85, TK62.85 M, TK65, TK65F, TK65V, TK70, TK70.65, TK70.65 M, TK70.75, TK70.75 M, TK70A, TK70FA, TK70VA, TK72.85, TK72.85 M, TK75, TK75A, TK75F, TK75FA, TK75M, TK75MA, TK75V, TK75VA, TK76, TK76M, TK80.65, TK80.66 DT, TK80.75, TK80A, TK80MA, TK82.85 M, TK85, TK85.55, TK85M, TK88.85 M, TK90A, TK90MA, TK95.55, TK95M, TL65, TL70, TL80, TL90, TL100, TN55D, TN55S, TN55V, TN60DA, TN60SA, TN60VA, TN65D, TN65F, TN65N, TN65S, TN65V, TN70D, TN70DA, TN70F, TN70NA, TN70S, TN70SA, TN70VA, TN75D, TN75DA, TN75F, TN75FA, TN75N, TN75NA, TN75S, TN75SA, TN75V, TN75VA, TN80F, TN85FA, TN90F, TN95F, TN95FA, TN95NA, TN95VA	5096235, 596152, 77902285

**MANICOTTI INFERIORI ADATTABILI**

MANCHONS ADAPTABLE

HOSE ADAPTABLE

KUEHLERSCHLAHUELSE PASSEND ZU

MANGOS ADAPTABLE



Art./Ref.	Brand	Applicazione/Application	Rif. Orig./Orig. Ref.
08626	CASE	AVJ55 - AVJ60 - AVJ70, JX100U-JX1060C-JX1060V, JX1070C-JX1070N-JX1070V, JX1075C-JX1075N-JX1075V, JX1095N-JX1095V, JX55-JX60-JX65-JX70, JX70U-JX75-JX80-JX80U, JX85-JX90-JX90U-JX95, VJ60 - VJ70 - VJ80	596152
28504		JX100U, JX70U, JX80U, JX90U	4997262
08562	FIAT	411R, 415	10134986
08626		100.90-100.90DT, 1000, 110.90-110.90 DT, 115.90-115.90 DT, 1180, 130.90-130.90 DT, 140.90-140.90 DT, 35.66-35.66DT, 45.66-45.66DT, 45.66S-45.66S DT, 450, 450R, 450V, 455C, 480, 480V, 50.66-50.66DT, 50.66S-50.66S DT, 500, 500S, 505C, 540, 540V, 55.46-55.46DT, 55.56-55.56DT, 55.66-55.66DT, 55.66LP-55.66LP DT, 55.66S-55.66S DT, 55.88-55.88DT, 55.90-55.90DT, 550, 555C, 56.66S-56.66S DT, 580, 60.46-60.46 DT, 60.56-60.56 DT, 60.66-60.66 DT, 60.66F-60.66F DT, 60.66LP-60.66LP DT, 60.66S-60.66S DT, 60.76F-60.76F DT, 60.88-60.88 DT, 60.90-60.90DT, 60.93-60.93DT, 60.94-60.94 DT, 600, 605C, 62.86F-62.86F DT, 640, 65.46-65.46DT, 65.56-65.56DT, 65.66-65.66DT, 65.66S-65.66S DT, 65.88-65.88DT, 65.90-65.90DT, 65.93-65.93 DT, 65.94-65.94 DT, 680, 70.56-70.56DT, 70.66-70.66DT, 70.66F-70.66F DT, 70.66LP-70.66LP DT, 70.66S-70.66S DT, 70.66V-70.66V DT, 70.76F-70.76F DT, 70.76LP-70.76LP DT, 70.76V-70.76V DT, 70.88-70.88DT, 70.90-70.90DT, 72.86F-72.86F DT, 72.86LP-72.86LP DT, 72.93-72.93DT, 72.94-72.94DT, 780, 80.66-80.66DT, 80.66F-80.66F DT, 80.66S-80.66S DT, 80.76F-80.76F DT, 80.88-80.88DT, 80.90-80.90DT, 82.86F-82.86F DT, 82.86LP-82.86LP DT, 82.93-82.93DT, 82.94-82.94DT, 85.90-85.90DT, 855C, 88.93-88.93DT, 88.94-88.94DT, 880/5, 90.90-90.90DT, 955C, 980, F100-F100DT, F110-F110DT, F115-F115DT, F120-F120DT, F130-F130DT, F140-F140DT	5096235, 596152, 77902285
28504		100.90-100.90DT, 110.90-110.90DT, 55.90-55.90DT, 570, 580, 60.90-60.90DT, 65.90-65.90DT, 65.94-65.94DT, 670, 680, 70.90-70.90DT, 72.94-72.94DT, 80.90-80.90DT, 82.94-82.94DT, 90.90-90.90DT	4997262
36414		SOM880/4	4997337
08626	FORD	3010S - 4010S - 5010S, 3435, 3935, 4030 - 4230 - 4430 - 8430, 4135, 4635, 4835, 5635, 6635, 7635	596152, 77902285
21821		2000, 2100, 2110, 2120, 2150, 2300, 231 - 233 - 333 - 335 - 420, 2310, 2600, 2610, 2810, 2910, 3000, 3100, 3120, 3150, 3190, 3230, 3300, 3310, 3400, 3430, 3500, 3600, 3610, 3900, 3910, 3930, 4000, 4100, 4110, 4130, 4140, 4190, 4200, 4400, 4450, 4500, 4550, 4600, 4610, 4630, 4830, 5030	81805637, C5NN8286B
21822		5000, 5100, 5110, 5190, 5200, 5550, 5600, 5610, 5900, 6550, 6600, 6610 SENZA ARIA CONDIZIONATA, 7000, 7100, 7550, 7600	81805638, C5NN8286C
28504		4635, 4835, 5635, 7635	4997262
41888		8530, 8630, 8730, 8830, TW 15, TW 25, TW 35, TW 5	83933452, D8NN8B298AB



Art./Ref.	Brand	Applicazione/Application	Rif. Orig./Orig. Ref.
41889	FORD	7910, 8210	83929876, E1N-N8291AA
42152		5640, 6640, 7740, 7840, 8240, 8340	81862945, 81863336, 81868754, FON-N8286AA, FONN8286AB
42157		7810, 7810S, 8010	83961071, E7N-N8286AA
42161		8000, 8200, 8600	81820455, C7NN8286A
38752	JOHN DEERE	1020, 1030, 10300U, 1030VU, 1035, 1035EF, 1035EV, 1040, 1040V, 1120, 1130, 1140, 1140F, 1140V, 1350, 1520, 1550, 1630, 16300U, 1630VU, 1635, 1635EF, 1635EV, 1750, 1750V, 1830, 1850, 1850F, 1850N, 1850V, 2020, 2030, 20300U, 2035, 2035EF, 2040, 2120, 2130, 2135, 2150, 2155, 2240, 2440, 820, 830, 840, 920, 930, 930VU, 940, 940V	T22500
38755		2940, 2950, 3040, 3140, 3150, 3340, 3640, 3640S, 4040	L34922
40618	LANDINI	6550, 7550, 8550	1427275M1
40638		16000, 16500	3040882M92
40555	MASSEY FERGUSON	3125, 3140, 3635, 3645, 3655, 3660	3581959M1
40597		35	828147M1
40599		133, 135, 135V, 140, 145, 145S, 145V, 148, 152, 152F, 152S, 152V, 40	186968M1, 414136M1
40600		135, 135V, 148, 20B, 20E, 230, 235, 240, 245, 250, 255	1860374M2
40603		340, 342, 350, 352, 355, 360	1694711M3
40604		20D, 550	1662089M1
40606		TEA20, TED20, TEH20	7126
40608		FE35	826988M1
40609		TEF20	2413
40611		35, 65, 765, 865	826775M1
40613		165, 50	898065M1
40615		165, 168, 168F, 168S, 175S, 185, 265, 275, 275E, 30D, 50, 50B, 50B MKII, 50D, 50E, 375E, 50EX, 50H, 50H-S, 50HX, 50HX-S, 565, 60H, 60H-S, 675	194737M1, 898748M1
40618		284S, 294S	1427275M1
40620		362, 362N, 372N, 382N	1695868M1
40622		365, 375, 390, 390T, 398	1695562M1
40624		399	1695564M1
40630		1004, 298, 698	1669806M1
40638		2620, 2625, 2640, 2645, 2680, 2685, 2720, 2725, 3610, 3630, 3650	3040882M92
40640		3050, 3060, 3065, 3065S	3382984M1
40644		3080, 3090	3382985M1
08626	NEW HOLLAND	L60, L65, L75, L85, L95, SERIE TL, TK100.55, TK100A, TK55, TK55.65 F, TK55.65 M, TK55.65 V, TK55.75 F, TK55.75 M, TK55.75 V, TK55.85 F, TK55.85 M, TK55.85 V, TK60.65, TK60.65 M, TK60.65 V, TK60.75, TK60.75 F, TK60.75 M, TK60.75 V, TK60.85 F, TK60.85 V, TK60A, TK62.85, TK62.85 M, TK65, TK65F, TK65V, TK70, TK70.65, TK70.65 M, TK70.65 V, TK70.75, TK70.75 M, TK70A, TK70FA, TK70VA, TK72.85, TK72.85 M, TK75, TK75A, TK75F, TK75FA, TK75M, TK75MA, TK75V, TK75VA, TK76, TK76M, TK80.65, TK80.66 DT, TK80.75, TK80A, TK80MA, TK82.85 M, TK85, TK85.55, TK85M, TK88.85 M, TK90A, TK90MA, TK95.55, TK95M, TL65, TL70, TL80, TL90, TL100, TN55D, TN55S, TN55V, TN60DA, TN60SA, TN60VA, TN65D, TN65F, TN65N, TN65S, TN65V, TN70D, TN70DA, TN70F, TN70NA, TN70S, TN70SA, TN70VA, TN75D, TN75DA, TN75F, TN75FA, TN75N, TN75NA, TN75S, TN75SA, TN75V, TN75VA, TN80F, TN85FA, TN90F, TN95F, TN95FA, TN95NA, TN95VA	5096235, 596152, 77902285
28504		L60, L65, L75, L85, L95, TL100, TL70, TL80, TL90	4997262
42152		TS120 (BRASIL), TS80, TS90, TS100, TS110, TS115, TS90E, TS100E, TS115E	81862945, 81863336, 81868754

**TAPPI RADIATORI ADATTABILI**

BOUCHONS RADIATEUR ADAPTABLE

RADIATOR PLUGS ADAPTABLE

CAPS KÜHLER PASSEND ZU

TAPONES DE RADIADOR ADAPTABLE

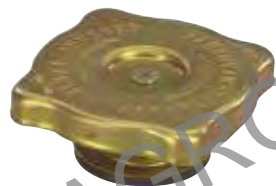

Art./Ref.	Brand	Applicazione/Application	Rif. Orig./Orig. Ref.
<b>08487</b>	<b>FIAT</b>	100.90-100.90 DT, 110.90-110.90 DT, 1300, 1380, 1580, 1880, 35.66-35.66 DT, 45.66-45.66 DT, 45.66S-45.66S DT, 45.76V-45.76V DT, 470, 474, 580, 680, 780, 855, 50.66-50.66 DT, 50.66S-50.66S DT, 50.86S V-50.86S V DT, 50.86V-50.86V DT, 55.46-55.46 DT, 55.56-55.56 DT, 55.66-55.66 DT, 55.66F-55.66F DT, 55.66S-55.66S DT, 55.66V-55.66V DT, 55.76F-55.76F DT, 55.76V-55.76V DT, 55.86F-55.86F DT, 55.86S V-55.86S V DT, 55.86V-55.86V DT, 55.88-55.88 DT, 55.90-55.90 DT, 56.66-56.66S DT, 60.46-60.46 DT, 60.56-60.56 DT, 60.66-60.66 DT, 60.66S-60.66S DT, 60.76F-60.76F DT, 60.86F-60.86F DT, 60.86S V-60.86S V DT, 60.86V-60.86V DT, 60.88-60.88 DT, 60.90-60.90 DT, 60.93-60.93 DT, 60.94-60.94 DT, 62.86F-62.86F DT, 65.46-65.46 DT, 65.56-65.56 DT, 65.66S-65.66S DT, 65.88-65.88 DT, 65.90-65.90 DT, 65.93-65.93 DT, 65.94-65.94 DT, 70.56-70.56 DT, 70.66-70.66 DT, 70.66S-70.66S DT, 70.76F-70.76F DT, 70.76LP-70.76LP DT, 70.76V-70.76V DT, 70.86S V-70.86S V DT, 70.86V-70.86V DT, 70.88-70.88 DT, 70.90-70.90 DT, 72.86F-72.86F DT, 72.86LP-72.86LP DT, 72.93-72.93 DT, 72.94-72.94 DT, 80.66-80.66 DT, 80.66S-80.66S DT, 80.76F-80.76F DT, 80.76F-80.76F DT, 80.88-80.88 DT, 80.90-80.90 DT, 82.86F-82.86F DT, 82.86LP-82.86LP DT, 82.93-82.93 DT, 82.94-82.94 DT, 85.90-85.90 DT, 88.93-88.93 DT, 88.94-88.94 DT, 880, 955, 980, 1180, 1280, 90.90-90.90 DT, F100 - F100DT, F110 - F110DT, F115 - F115DT, F120 - F120DT, F130 - F130DT, F140 - F140DT	4999682
<b>08497</b>	<b>FIAT</b>	100.90-100.90 DT, 1000, 110.90-110.90 DT, 1180, 1280, 1300, 1355C, 1380, 1580, 1880, 200R, 211RB, 215C, 221, 250, 255, 300, 311, 312, 315, 321, 331, 332, 35.66-35.66 DT, 350, 351, 352C, 355C, 366, 400, 411, 412, 415, 420, 421, 431, 440, 441, 446, 45.66-45.66 DT, 450, 451, 455C, 460, 465, 466, 470, 474, 480, 50.66-50.66 DT, 50.86-50.86 DT, 50.88-50.88 DT, 500, 500 ST, 505C, 540, 55.46-55.46 DT, 55.56-55.56 DT, 55.66-55.66 DT, 55.66S-55.66S DT, 55.86-55.86 DT, 55.88-55.88 DT, 55.90-55.90 DT, 550, 565C, 566, 570, 580, 60.46-60.46 DT, 60.56-60.56 DT, 60.66-60.66 DT, 60.66-60.66 DT, 60.88-60.88 DT, 60.90-60.90 DT, 60.93-60.93 DT, 60.94-60.94 DT, 600, 605C, 640, 65.46-65.46 DT, 65.56-65.56 DT, 65.66-65.66 DT, 65.88-65.88 DT, 65.90-65.90 DT, 65.93-65.93 DT, 65.94-65.94 DT, 650, 655, 655C, 666, 670, 680, 70.56-70.56 DT, 70.66-70.66 DT, 70.88-70.88 DT, 70.90-70.90 DT, 72.93-72.93 DT, 72.94-72.94 DT, 750, 765, 766, 780, 80.66-80.66 DT, 80.88-80.88 DT, 80.90-80.90 DT, 805, 82.93-82.93 DT, 82.94-82.94 DT, 850, 855C, 88.93-88.93 DT, 88.94-88.94 DT, 880, 880-5, 90.90-90.90 DT, 900, 95.55-95.55 DT, 980, 995C, A100SDT-A110-A110SDT, A140-A140DT-A90-DT, F100-F110-F115-F120-F130, G170-G190-G210-G240	4988491, 590054, 9966958
<b>14025</b>	<b>FIAT-ALLIS</b>	1355C, FL14E-FR10-FR10B-FR15B, FR20-FR20B-FR20B TURBO, FR7-FR8-FR9-FD14E	4957787, 4959324, 576992, 76008464, 76027863, 8512472, 76008464, 76027863
<b>14492</b>	<b>FIAT</b>	100.90-100.90 DT, 110.90-110.90 DT, 55.90-55.90 DT, 60.90-60.90 DT, 65.90-65.90 DT, 65.94-65.94 DT, 70.66-70.66 DT, 70.66S-70.66S DT, 70.90-70.90 DT, 72.94-72.94 DT, 80.66-80.66 DT, 80.66S-80.66S DT, 80.90-80.90 DT, 82.94-82.94 DT, 85.90-85.90 DT, 88.94-88.94 DT, 90.90-90.90 DT, F100-F100 DT, F110-F110 DT, F115-F115 DT, F120-F120 DT, F130-F130 DT, F140-F140 DT	4274034
<b>26775</b>		115.90, 115.90DT, 130.90, 130.90DT, 140.90, 140.90DT, 160.90, 160.90DT, 180.90, 180.90DT, TK160.55	5129231
<b>08487</b>		3435, 4135, 4635, 4835, 5635, 3830, 4030, 4230, 4430, 6635, 7635	4999682
<b>08497</b>		4635-4835-5635-6635-7635	4988491, 590054, 9966958
<b>14492</b>		4635, 4835, 5635, 6635, 7635	4274034
<b>21817</b>	<b>FORD</b>	2000, 2310, 2600, 2610, 2810, 2100-2300-3100-3300-4200-4400, 2110-3310-6410-6610-6710-6810, 2120-231-233-3120-333-335, 2150, 3150, 2910, 3000, 3055, 3600, 3610, 3190, 4190, 5190, 3230, 3400-3500-4140-420-4450-4500, 3430, 3900, 3910, 4000, 4100, 4110, 3930, 4130, 4550-5550-6550-7550, 4600, 4610, 5000, 5110, 5610, 4630, 4830, 5030, 5100-5200-5600-5700-5900, 5610S, 5640, 6410, 6610, 7000, 7410, 5600, 6600, 7610, 7710, 6600-6700-7100-7600-7700, 6610S, 6640, 7000, 8000, 9000, 7010, 7410-7610-7710-7910-8210, 7610S, 7740, 7810, 7810S, 7840, 7910, 8210, 8530, 8630, 8730, 8010, 8240, 8340, 8530, 8630, 8730, 8830, 8600-8700-9200-9600-9700, 8670, 8770, 8830, TW5, TW15, TW25, TW35, 8870, 8970, TW10, TW20, TW30	211E8100A1, 81854756, 83917658, 83935905, D2AE8100A1A, E2NN8100BA
<b>26775</b>		8430, 8630, 8830	5129231
<b>42056</b>		DEXTA, MAJOR, POWER MAJOR, SUPER DEXTA, SUPER MAJOR	81711544, 81711545, 87712917, E62A8100A

Art./Ref.	Brand	Applicazione/Application	Rif. Orig./Orig. Ref.
08497	LANDINI	10000, 12500, 13000, 14500, 4000/DT, 4000R, 4000S, 4500R, 5000/DT, 5000/N, 5000/S, 5000R, 5500, 5830, 5840, 5860, 5870, 6030, 6040, 6060, 6070, 6500, 6550, 6830, 6840, 6860, 6870, 6880, 7500, 7550, 7830, 7860, 7870, 7880, 8500, 8550, 8830, 8860, 8870, 8880, 9060, 9080, 9880, ADVANTAGE CAB E FOOT STEP: 60, ADVANTAGE CAB E FOOT STEP: 75, ADVANTAGE CAB E FOOT STEP: 85, ADVANTAGE CAB E FOOT STEP: 55, ADVANTAGE CAB E FOOT STEP: 60, ADVANTAGE CAB E FOOT STEP: 65, ADVANTAGE CAB: 85, CLIMA TROPICA, ADVANTAGE: L95GT, ATLAS: 70, ATLAS: 75, ATLAS: 80, ATLAS: 100, ATLAS: 85, ATLAS: 90, BLIZZARD: 50, BLIZZARD: 60, BLIZZARD: 65, BLIZZARD: 75, BLIZZARD: 85, BLIZZARD: 95, CINGOLATI : C6830(FINO A 320B01, CINGOLATI: C6830, CINGOLATI: C7830, CINGOLATI: C4500, CINGOLATI: C4830, CINGOLATI: C5000, CINGOLATI: C5830, CINGOLATI: C6500, CINGOLATI: C7800, CINGOLATI: C8860, CINGOLATI: CF4830, CINGOLATI: CF5030, CINGOLATI: CF5830, CINGOLATI: CF6030, CINGOLATI: CF6060, CINGOLATI: CF6830, FRUTTETI 530 F/L/V: 6030F/L, FRUTTETI 530 F/L/V: 4530V, FRUTTETI 530 F/L/V: 5530F/L, FRUTTETI 530 F/L/V: 5530V, FRUTTETI 530 F/L/V: 6030F/L, FRUTTETI 530 F/L/V: 6030V, FRUTTETI 530 F/L/V: 6030V, CLIMA, FRUTTETI 530 F/L/V: 6530F/L, FRUTTETI 530 F/L/V: 6530V, FRUTTETI 530 F/L/V: 6530L, FRUTTETI 530 F/L/V: 6530V, FRUTTETI 530 F/L/V: 7530F/L, FRUTTETI 530 F/L/V: 7530V, FRUTTETI 530 F/L/V: 8530F/L, FRUTTETI 530 F/L/V: 8530V, FRUTTETI 530 F/L/V: 8530L, CLIMA, FRUTTETI 560 F/L/V: 5560F/L, FRUTTETI 560 F/L/V: 5560V, FRUTTETI 560 F/L/V: 6060F/L, FRUTTETI 560 F/L/V: 6060V, FRUTTETI 560 F/L/V: 6060V, CLIM, FRUTTETI 560 F/L/V: 6560F/L, FRUTTETI 560 F/L/V: 7560F/L, FRUTTETI 560 F/L/V: 8560F/L, CL, FRUTTETI 560F/L/V: 6560V, FRUTTETI 560F/L/V: 8560 F/L, NEW SERIE 60: 5860, NEW SERIE 60: 6860, NEW SERIE 60: 7860, NEW SERIE 60: 8860, REX CAB E.F.S.: 100, REX CAB E.F.S.: 70, REX CAB E.F.S.: 80, REX CAB E.F.S.: 90, REX CAB E.F.S.: 60, REX CAB E.F.S.: 60, SENZA ARIA CO, TEKKEK CF: CF55, TEKKEK CF: CF60, TREKKER C: C75, TREKKER C: C85, TREKKER C: C95, TREKKER CF: CF65, TREKKER CF: CF75, TREKKER CF: CF85, TREKKER NEW: 80C/F/L, TREKKER NEW: 70C/F/L, TREKKER NEW: 80C/F/L, TREKKER NEW: 90C/F/L, TREKKER NEW: 90C/F/L, CLIMA TROP, TREKKER: CF70, TREKKER: CF70, CLIMA TROPICALE, VIGNETI CAB E.F.S.: 60V, VIGNETI CAB E.F.S.: 55V, VIGNETI CAB E.F.S.: 60V, CLIMA TR, VIGNETI CAB E.F.S.: 65V, VIGNETI CAB E.F.S.: 75V, VIGNETI REX CAB TIER 2: 75V, VIGNETI REX CAB TIER 2: 85V, VIGNETI REX CAB: 60V, VIGNETI REX CAB: 65V, VIGNETI REX CAB: 65V, SENZA ARI, VIGNETI REX CAB: 70V, VIGNETI REX CAB: 80V	1824628M91
08497	MASSEY FERGUSON	1007-1014-1024, 1104-1114-1134, 134C-134V, 154-154C-154F-154S-154V, 164TF-164TS-164TV, 174-174C-174F-174S-174V, 184-184F-184S-194S, 233-234C-234CF-234S-244CF, 253-254-254C-254CF-254S, 263T-264T-264TCF-264TS, 274CF-274S-274SK, 283-284-284S, 293-294-294C-294S, 3210FP-3210GE-3210SP, 3220AP-3220FP-3220GE-3220SP, 3225AP-3225FP-3225GE-3225SP, 3235AP-3235FP-3235GE-3235SP, 333-334V-353-353LX-353S, 354AP-354AQ-354FP-354FQ, 354GE-354S-354SP-354VQ, 356CF-363-363LX-363S, 364AP-364AQ-364CF-364FP-364FQ, 364GE-364S-364SP-364SQ-364V, 364VQ-366CF-367CF, 373-373LX-373S-374AP-374AQ, 374F-374FP-374FQ-374S-374SP, 374SQ-374V-374VQ-376C-376CF, 376XCF-377, 383-383LX-383S-384AP-384AQ, 384F-384FP-384FQ-384GE-384S, 384SP-384SQ-384V-384VQ, 393LX-393S-393TLX, 394AP-394AQ-394C-394F-394FP, 394FQ-394H-394S-394SP-394SQ, 394TAQ-396C-396CF-396CT, 397-397T	1824628M91
11291		133, 135, 135V, 140, 145, 145S, 165, 168, 168F, 168S, 175S, 178, 185, 188	24850017, 24850020, 3637301M1, 3637939M1, 885344M1
11292		230, 235, 240, 245, 253, 255, 260, 263, 263T, 265, 275, 275E, 285, 290, 290E, 298, 375E, 390E, 550, 560, 565, 575, 590	1874445M93, 1874445M94
11890		133, 135, 135V, 140, 145, 145S, 145V, 148, 152, 152F, 152S, 152V, 155, 158, 158F, 158S, 158V, 165, 175, 35, 65, 765, 865, FE35	3475308M1, 826772M1, 968976M2
40582		1080 - 1085, 592 - 595	531505M91
08487	NEW HOLLAND	L60-L65-L75-L85-L95, TD4020F-TD4030F-TD4040F, TD55D-TD65D-TD75D-TD85D, TD60-TD70-TD80-TD90-TD95, TD65F-TD75F-TD85F, TK100A, TK65F, TK70FA, TK70VA, TK75F, TK75FA, TK75M, TK75MA, TK75V, TK75VA, TK76, TK76M, TK80A, TK80MA, TK85, TK85M, TK90A, TK90MA, TK95M, TL70-TL80-TL90-TL100, TL70A-TL80A-TL90A-TL100A, TN55-TN65-TN70-TN75, TN55D-TN65D-TN70D-TN75D, TN55S-TN65S-TN70S-TN75S, TN55V-TN65V-TN75V, TN60A-TN70A-TN75A-TN85A-TN95A, TN60DA, TN60SA-TN70SA-TN75SA-TN75SA, TN60VA-TN70VA-TN75VA-TN95VA, TN65F-TN65F-TN70F-TN75F, TN65N, TN70DA, TN70F, TN70NA-TN95NA, TN75DA, TN75F, TN75FA, TN75FA-TN85FA-TN95FA, TN75N, TN75NA, TN80F, TN80F-TN90F-TN95F, TN85DA, TN90F, TN95DA, TN95F, TN95FA, TT50-TT55-TT65-TT75	4999682
08497		L411-L413-L416-L516, L60-L65-L75-L80, L85-L90-L95-L115, M100-M115-M135-M160, TD55D-TD65D-TD75D-TD85D-TD95D, TK65F-TD65V, TK76-TK76M, TK85-TK85M, TL70-TL80-TL90-TL100, TN55-TN65-TN70-TN75-TN90, TN55D-TN65D-TN70D-TN75D, TN55S-TN65S-TN70S-TN75S, TN55V-TN65V, TN65F-TN70F-TN75F, TN65N, TN80F-TN90F-TN95F	4988491, 590054, 9966958
14492		L60-L65-L75-L85-L95, T4.105N-T4.95N-T4.95V, T4.105V-T4.85V-T4.85N, T4.55-T4.65-T4.75, T4.75F-T4.85F-T4.95F-T4.105F, T4.75V-T4.65V-T4.75N, T4020-T4030-T4040-T4050, T4020V-T4030V-T4040V, T4030F-T4040F-T4050F-T4060F, T4030N-T4040N-T4050N-T4060N, T4050V-T4060V, T5030-T5040-T5050-T5060-T5070, TC45A, TD4020F-TD4030F-TD4040F, TD5.100-TD5.105-TD5.110, TD5.115, TD5.65-TD5.75-TD5.80-TD5.85, TD5.90-TD5.95, TD5010-TD5020-TD5030, TD5040-TD5050, TD60-TD70-TD80-TD90-TD95, TD60D-TD70D-TD80D-TD90D-TD95D, TD65F-TD75F-TD85F, TK100-55, TK100A, TK4020F, TK4020V, TK4030, TK4030F, TK4030V, TK4040, TK4040M, TK4050, TK4050M, TK4060, TK70FA, TK70VA, TK75F, TK75FA, TK75M, TK75MA, TK75V, TK75VA, TK85.55, TK90A, TK90MA, TK95.55, TK95M, TL100, TL60-TL65-TL70-TL75, TL60E-TL75E-TL85E-TL95E, TL70A-TL80A-TL90A-TL100A, TL80-TL85-TL90-TL95, TN55-TN65-TN70-TN75, TN55D-TN65D-TN70D-TN75D, TN55S-TN65S-TN70S-TN75S, TN60A-TN70A-TN75A-TN85A-TN95A, TN65F-TN75F-TN90F, TN65F-TN75F-TN90F-TN95F, TN70DA-TN75DA-TN85DA-TN95DA, TN70NA-TN95NA, TN70SA-TN75SA-TN85SA, TN70VA-TN75VA-TN95VA, TN75N, TN75NA, TN75V, TN85FA-TN95FA, TN95F-TN95FA	4274034
21817	TD5010-TD5020-TD5030, TD5040-TD5050, TD55D-TD60D-TD65D-TD70D, TD65B, TD75D-TD80D-TD85D-TD90D-TD95D, TT65D	83935905	

**VENTOLE DI RAFFREDDAMENTO ADATTABILI**

VENTILATEUR REFRAICHISSEMENT ADAPTABLE

COOLING FANS ADAPTABLE

KÜHLVENTILATOREN PASSEND ZU

VENTALLS DE INFRIAMIENTO ADAPTABLE



Art./Ref.	Brand	Applicazione/Application	Rif. Orig./Orig. Ref.	Note/Note
14240		100.90-100.90DT, 1000S, 110.90-110.90DT, 115.90-115.90DT, 1180, 1280, 1380, 90.90-90.90DT, 980	4705372	4 Pale aspirate/4 Wheel aspirated
14244	FIAT	440V, 450, 540S, 55.46-55.46DT, 55.56-55.56DT, 55.66-55.66DT, 55.66S-55.66S DT, 55.88-55.88DT, 550, 566, 570V/F/DT, 60.46-60.46DT, 60.56-60.56DT, 60.66-60.66DT, 60.66S-60.66S DT, 60.88-60.88DT, 60.93-60.93DT, 60.94-60.94DT, 600DT, 640, 65.46-65.46DT, 65.56-65.56DT, 65.66-65.66DT, 65.66S-65.66S DT, 65.88-65.88DT, 65.93-65.93DT, 666, 70.56-70.56DT, 70.66-70.66DT, 70.66S-70.66S DT, 70.88-70.88DT, 72.93-72.93DT, 766, 80.66-80.66DT, 80.66S-80.66S DT, 80.88-80.88DT, 82.93-82.93DT, 88.93-88.93DT	4593320	4 Pale aspirate/4 Wheel aspirated
14246		1300S	4698308, 8827731, 8829763	4 Pale aspirate/4 Wheel aspirated
14331		1280, 130.90-130.90DT, 1380	4720206, 4796434, 4796435, 5171295	6 Pale aspirate/6 Wheel aspirated
14244		3010S - 4010S - 5010S	4593320	4 Pale aspirate/4 Wheel aspirated
14331		4635, 4835, 5635, 6635, 7635	4796435	6 Pale aspirate/6 Wheel aspirated
42050	FORD	2000, 2100, 2110, 2120, 2300, 230A, 231, 2310, 233, 234, 2600, 2600N, 2600R, 2600V, 2610, 2610V, 2810, 2910, 3000, 3055, 3100, 3120, 3230, 3300, 3310, 333, 3330, 334, 335, 3400, 3430, 345C, 345D, 3500, 3550, 3600, 3600N, 3600NO, 3600R, 3600V, 3610, 3610NO, 3610V, 3900, 3910, 3910H, 3910N, 3910R, 3910V, 3930, 3930H, 3930N, 3930NO, 4000, 4100, 4110, 4110N, 4110NO, 4110O, 4110V, 4130, 4130N, 4130NO, 4140, 420, 4200, 4330, 4340, 4400, 4410, 445C, 445D, 4500, 4600, 4600NO, 4600O, 4600SU, 4610, 4610NO, 4610SU, 4630, 4630N, 4630NO, 4630O, 4830, 4830N, 4830O, 5000, 5030, 5030O, 5100, 515, 5200, 530A, 531, 532, 5340, 535, 545C, 545D, 550, 5500, 555, 555A, 555B, 555C, 555D, 5600, 5640, 5700, 575D, 655, 655A, 655C, 655D, 6600, 6600C, 6600O, 6700, 675D, 7000, 7100, 7200, 7600, 7600C, 7700	83918898	6 Pale aspirate/6 Wheel aspirated
11293		5830	825181M91	4 Pale aspirate/4 Wheel aspirated
11294	LANDINI	4530V, 4560V, 5500, 5505, 5530-5530F-5530L-5530V, 5560F-5560L-5560V, 5830, 5840, 5860, 5870, 6030-6030F-6030L-6030V, 6040, 6060-6060F-6060L-6060V, 6070, 6505, ADVANTAGE 55F-FP-GE-GT-GTP, ADVANTAGE 55L-LP, ADVANTAGE 60F-FP-GE-GT-GTP, ADVANTAGE 60L-LP, BLIZZARD 50 - 60, C4500, C4830, C5500, C5830, C6030F, CF4830, CF5030, CF5830, CF6060, GLOBUS 50, REX 60FP - 60GE - 60LP, REX 60V, REX CAB 60, TREKKER CF55 - CF60, VIGNETI 55V, VIGNETI FOOTSTEP 55V, VIGNETI REX CAB 60V	3539008M91	Pala singola/Single blade
11295		4530V, 4560V, 5500, 5505, 5530-5530F-5530L-5530V, 5560F-5560L-5560V, 5830, 5840, 5860, 5870, 6030-6030F-6030L-6030V, 6040, 6060-6060F-6060L-6060V, 6070, 6505, ADVANTAGE 55F-FP-GE-GT-GTP, ADVANTAGE 55L-LP, ADVANTAGE 60F-FP-GE-GT-GTP, ADVANTAGE 60L-LP, BLIZZARD 50 - 60, C4500, C4830, C5500, C5830, C6030F, CF4830, CF5030, CF5830, CF6060, GLOBUS 50, REX 60FP - 60GE - 60LP, REX 60V, REX CAB 60, TREKKER CF55 - CF60, VIGNETI 55V, VIGNETI FOOTSTEP 55V, VIGNETI REX CAB 60V	3539007M91	Pala singola/Single blade

Art./Ref.	Brand	Applicazione/Application	Rif. Orig./Orig. Ref.	Note/Note
11296	LANDINI	6500, 6530F, 6530L, 6530V, 6550, 6830, 6840, 7500, 7505, 7530F, 7530L, 7550, 7830, 8500, 8530F, 8530L, 8550, 8830, C6500, C6830, C7800	1885172M1, 894729M1	Pala singola superiore/ Single blade top
11297		6500, 6530F, 6530L, 6530V, 6550, 6830, 6840, 7500, 7505, 7530F, 7530L, 7550, 7830, 8500, 8530F, 8530L, 8550, 8830, C6500, C6830, C7800	1885173M1, 894730M1	Pala singola inferiore/ Shovel single bottom
40556		6500, 6530L - 6530V, 6550, 6560F - 6560L - 6560V, 6830, 6840, 6860, 6870, 6880, 7500, 7530F - 7530L, 7550, 7560F - 7560L - 7560V, 7830, 7860, 7870, 7880, 8500, 8530F - 8530L, 8550, 8560F - 8560L, 8830, 8860, 8870, 8880, ADVANTAGE: 65GTP, ADVANTAGE: 75GTP, ADVANTAGE: 85GTP, ATLAS: 70, ATLAS: 75, ATLAS: 80, BLIZZARD: 65, BLIZZARD: 75, BLIZZARD: 85, BLIZZARD: 95, CINGOLATI: C6500, CINGOLATI: C6830, CINGOLATI: C7800, CINGOLATI: C7830, CINGOLATI: C8860, CINGOLATI: CF6830, GLOBUS: 55, GLOBUS: 60, GLOBUS: 70, REX 60V, REX 65V, REX CAB E FOOT STEP: 60, REX CAB E FOOT STEP: 70, REX CAB E FOOT STEP: 80, TREKKER NEW TIER 2: 75, TREKKER NEW TIER 2: 85, TREKKER: C70, TREKKER: C75, TREKKER: C85, TREKKER: C95, TREKKER: CF70, TREKKER: CF75, TREKKER: CF80, TREKKER: CF85, TREKKER: CF95, VIGNETI CAB E FOOT STEP: 65V, VIGNETI CAB E FOOT STEP: 75V, VIGNETI REX CAB : 60V, VIGNETI REX CAB : 65V, VIGNETI REX CAB : 70V, VIGNETI REX CAB : 80V	1874995M92	6 Pale aspirate/6 Wheel aspirated
11293	MASSEY FERGUSON	135, 145, 148, 152, 20 - 20B - 20D - 20E - 20F, 230, 240, 250, 253, 30 - 30E - 30H - 40 - 40E, 342, 35 - 35EX - FE35, 350, 355, 360, 550, TE20 - TEA20 - TED20 - TFF20	3638342M91, 825181M91	4 Pale aspirate/ 4 Wheel aspirated
11294		133, 134C-134V, 135, 135V, 140, 145, 145S-145V, 148, 150, 152, 152F-152S-152V, 154, 154C-154F-154S-154V, 155, 158, 158F-158S-158V, 164TF-164TS-164TV, 165, 220S, 230, 233, 234C-234CF-234S, 235, 240, 243, 244CF, 245, 250, 253, 254, 254C-254CF-254S, 255, 260, 263T, 264T-264TCF-264TS, 3210FP-3210GE-3210SP, 333, 334V, 340, 342, 350, 352, 353-353LX-353S, 354AP-354AQ-354F-354FP-354FQ, 354GE-354S-354SP-354SQ, 354V-354VQ, 355, 356CF, 360, 363-363LX-363S, 364AP-364AQ-364CF, 364F-364FP-364FQ-364GE, 364S-364SP-364SQ-364V-364VQ, 366CF, 550, 560, 65, 765	1884777M1, 897051M1, 963930M1	Pala singola/Single blade
11295		133, 134C-134V, 135, 135V, 140, 145, 145S-145V, 148, 150, 152, 152F-152S-152V, 154, 154C-154F-154S-154V, 155, 158, 158F-158S-158V, 164TF-164TS-164TV, 165, 220S, 230, 233, 234C-234CF-234S, 235, 240, 243, 244CF, 245, 250, 253, 254, 254C-254CF-254S, 255, 260, 263T, 264T-264TCF-264TS, 3210FP-3210GE-3210SP, 333, 334V, 340, 342, 350, 352, 353-353LX-353S, 354AP-354AQ-354F-354FP-354FQ, 354GE-354S-354SP-354SQ, 354V-354VQ, 355, 356CF, 360, 363-363LX-363S, 364AP-364AQ-364CF, 364F-364FP-364FQ-364GE, 364S-364SP-364SQ-364V-364VQ, 366CF, 550, 560, 65, 765	1884738M1, 897050M1, 963929M1	Pala singola/Single blade
11296		165, 168, 168F-168S, 174-174C-174F-174S-174V, 175, 175S, 178, 184-184F-184S, 185, 188, 194-194C-194F-194S, 265, 273, 274-274C-274CF-274S-274SK, 275, 283, 285, 293, 294S, 565, 575, 675	1885172M1, 894729M1	Pala singola superiore/ Single blade top
11297		165, 168, 168F-168S, 174-174C-174F-174S-174V, 175, 175S, 178, 184-184F-184S, 185, 188, 194-194C-194F-194S, 265, 273, 274-274C-274CF-274S-274SK, 275, 283, 285, 293, 294S, 565, 575, 675	1885173M1, 894730M1	Pala singola inferiore/ Shovel single bottom
40556		174-174C-174F-174S-174V, 194-194C-194F-194S, 265, 273, 274-274C-274CF-274S-274SK, 275, 275E, 283, 284-284S, 290, 290E, 293, 294-294C-294S, 375E, 390E, 394C-394H, 590, 675, 690	1874995M92, 3538983M91	6 Pale aspirate/6 Wheel aspirated
14240	NEW HOLLAND	TK100.55, TK95.55	4705372	4 Pale aspirate/4 Wheel aspirated
14244		TD55D, TD65D, TD75D, TD85D, TK60.65, TK60.65M, TK60.65V, TK60.75, TK60.75M, TK60.75V, TK62.85, TK62.85M, TK70.65, TK70.65M, TK70.75, TK70.75M, TK72.85, TK72.85M, TK80.65, TK80.66DT, TK80.75, TK82.85M, TK88.85M	4593320	4 Pale aspirate/4 Wheel aspirated
14331		L60 - L65 - L75 - L85 - L95, TD55D, TD60, TD60D, TD65D, TD70, TD70D, TD75D, TD80, TD80D, TD85D, TD90, TD90D, TD95, TD95D, TK100A, TK65F, TK65M, TK70FA, TK70VA, TK75F, TK75FA, TK75M, TK75MA, TK75V, TK75VA, TK76, TK76-M, TK80A, TK80MA, TK85, TK85-M, TK90A, TK90MA, TK95, TK95M, TL70 - TL80 - TL90 - TL100	4796434	6 Pale aspirate/6 Wheel aspirated

**RUBINETTO RADIATORE ADATTABILE**

 ROBINET RADIATEUR ADAPTABLE  
 RADIATOR TAP ADAPTABLE  
 KUHLEHAHN PASSEND ZU  
 LLAVE RADIADOR ADAPTABLE

Art./Ref.	Brand	Applicazione/Application	Rif. Orig./Orig. Ref.
<b>08484</b>	<b>FIAT</b>	1000, 100C, 120C, 1300, 1355C, 350, 420, 440, 45.76V, 450, 455C, 470, 474, 480, 50.86S VDT, 50.86V, 500, 505C, 540, 55.66FDT - 55.66V - 55.66VDT, 55.76F - 55.76FDT, 55.76V - 55.76VDT, 55.86F - 55.86FDT, 55.86SV - 55.86V - 55.86VDT, 570, 580, 60.86F - 60.86FDT, 60.86SV - 60.86SVDT, 60.86V - 60.86VDT, 605C, 640, 650, 655C, 670, 70.86SV - 70.86SVDT, 70.86V - 70.86VDT, 70C, 750, 780, 80C, 850, 880S, 980, 1180, 1280, 1380	4573802, 5118499, 8802902
<b>15341</b>		250, 300, 350, 420	568501
<b>15396</b>		415	990254
<b>08484</b>		3830	5118499
<b>11290</b>	<b>FORD</b>	2000, 2100, 2110, 2120, 2150, 2300, 231-233-333-335-420, 2310, 2600, 2610, 2810, 2910, 3000, 3100, 3120, 3150, 3190, 3230, 3300, 3310, 3400, 3430, 3500, 3600, 3610, 3900, 3910, 3930, 4000, 4100, 4110, 4130, 4140, 4190, 4200, 4400, 4450, 4500, 4550, 4600, 4610, 4630, 4830, 5000, 5030, 5100, 5110, 5190, 5200, 5550, 5600, 5610, 5610S, 5700, 5900, 6410, 6550, 6600, 6610, 6610S, 6700, 6710, 6810, 6810S, 7000, 7010, 7100, 7410, 7550, 7600, 7610, 7610S, 7700, 7710, 7810S, 7910, 8000, 8010, 8200, 8210, 8530, 8600, 8630, 8700, 8730, 8830, 9000, 9200, 9600, 9700, DEXTA, SUPER DEXTA, MAJOR, POWER MAJOR, SUPER MAJOR, TW10, TW20, TW30, TW5, TW15, TW25, TW35	81465471, 81821817, 81859483
<b>11290</b>	<b>JOHN DEERE</b>	1020, 1030, 1030VU, 1035EV, 1040, 1040V, 1120, 1130, 1140, 1140F, 1140V, 1350, 1520, 1530, 1550, 1630, 16300U - 1630VU, 1635, 1635EF, 1635EV, 1640, 1640F, 1750, 1750V, 1830, 1840, 1840F, 1850, 1850F - 1850N - 1850V, 2020, 2030, 20300U, 2035, 2035EF, 2040, 2040S, 2120, 2130, 2135, 2140, 2150, 2155, 2240, 2250, 2350, 2355, 2440, 2450, 2450F, 2550, 2555CS - 2555TSS, 2650, 2650CS - 2650F - 2650N, 2650TSS, 2750, 2755, 2840, 2850, 2855N, 2940, 2950, 2955, 3030, 3040, 3050, 3130, 3135, 3140, 3150, 3340, 3350, 3640, 3640S, 3650, 4040, 4040S, 5103, 5200, 5203, 5210, 5215, 5215F - 5215V, 5220, 5300, 5300N, 5303, 5310, 5310N, 5315, 5315F - 5315V, 5320, 5320N, 5400, 5400N, 5403, 5410, 5410N, 5415, 5415F - 5415V, 5415H - 5415N, 5420, 5420N, 5500, 5500N, 5510, 5510N, 5515, 5515F - 5515HC - 5515V, 5520, 5520N, 5605, 5615, 5615F - 5615V, 5705, 5715, 5715HC, 7600, 7610, 7700, 7710, 7800, 7810, 820, 830, 840, 930, 930VU, 940, 940V	AT13740, AT27653
<b>11290</b>	<b>LANDINI</b>	10000, 10000S, 12500, 13000, 14500, 3000R, 3000RV, 4000/DT, 4000R, 4000S, 4500R, 5000DT, 5000R, 5000R-N, 5000R-S, 5000S, 5500, 5505, 5830, 5840, 5860, 5870, 6000, 6000S, 6030, 6040, 6060, 6070, 6500, 6505, 6550, 6830, 6840, 6870, 6880, 7000S, 7500, 7505, 7550, 7830, 7860, 7870, 7880, 8000DT, 8000R, 8500, 8550, 8830, 8860, 8880, 9500, 9880, 9880HC, ADVANTAGE 55F-55L-55V, ADVANTAGE 60F-60L, ADVANTAGE 65L-65LP-65V, ADVANTAGE 75L-75LP-75V, BLIZZARD: 50, BLIZZARD: 60, BLIZZARD: 65, BLIZZARD: 75, CINGOLATI: C10500, CINGOLATI: C4500, CINGOLATI: C4830, CINGOLATI: C5000, CINGOLATI: C5830, CINGOLATI: C6000, CINGOLATI: C6830, CINGOLATI: C7800, CINGOLATI: C7830, CINGOLATI: C4500, CINGOLATI: C4830, CINGOLATI: C5500, CINGOLATI: C5830, CINGOLATI: C6500, CINGOLATI: C7800, CINGOLATI: C8860, CINGOLATI: CF4830, CINGOLATI: CF5030, CINGOLATI: CF5830, CINGOLATI: CF6060, CINGOLATI: CF6830, FRUTTETI 530 F/L/V: 6030F/L, FRUTTETI 530 F/L/V: 4530V, FRUTTETI 530 F/L/V: 5530F/L, FRUTTETI 530 F/L/V: 5530V, FRUTTETI 530 F/L/V: 6030F/L, CLI, FRUTTETI 530 F/L/V: 6030V, FRUTTETI 530 F/L/V: 6030V, CLIMA, FRUTTETI 530 F/L/V: 6530F/L/V, FRUTTETI 530 F/L/V: 6530F/V, FRUTTETI 530 F/L/V: 6530L, FRUTTETI 530 F/L/V: 7530F, FRUTTETI 530 F/L/V: 7530F/L, FRUTTETI 530 F/L/V: 7530L, FRUTTETI 530 F/L/V: 8530F, FRUTTETI 530 F/L/V: 8530L, FRUTTETI 530 F/L/V: 8530L, CLIMA, FRUTTETI 560 F/L/V: 5560F/L, FRUTTETI 560 F/L/V: 5560V, FRUTTETI 560 F/L/V: 6060F/L, FRUTTETI 560 F/L/V: 6060V, FRUTTETI 560 F/L/V: 6060V, CLIM, FRUTTETI 560 F/L/V: 6560F/L, FRUTTETI 560 F/L/V: 7560F/L, FRUTTETI 560 F/L/V: 8560F/L, CL, FRUTTETI 560F/L/V: 6560V, FRUTTETI 560F/L/V: 8560 F/L, REX 60V - 65V, TREKKER 55F - 60F - 65F - 75F, TREKKER 70C - 70F - 70L, TREKKER 80C - 80F - 80L, TREKKER 90C - 90F - 90L, TREKKER CF75, VIGNETI 55V - 60V - 65V - 75V	2461104
<b>11290</b>	<b>MASSEY FERGUSON</b>	1004 - 1004T, 1007, 1014, 1024, 1080, 1085, 1100, 1104, 1105, 1114, 1130, 1134, 1200, 122, 1250, 130, 133, 134C - 134V, 135, 135V, 140, 145, 145S - 145V, 148, 150, 152, 152F - 152S - 152V, 154, 154C - 154F - 154S - 154V, 155, 158, 158F - 158S - 158V, 164TF - 164TS - 164TS, 165, 168, 168F - 168S, 174, 174C - 174F - 174S - 174V, 175, 175S, 178, 184, 184F - 184S, 185, 188, 194, 194C - 194F - 194S, 2205, 2210, 2220, 2230, 230, 233, 234C - 234CF - 234S, 235, 240, 244CF, 245, 25, 250, 253, 254, 254C - 254CF - 254S, 255, 2620, 2625, 263T, 2640, 264T - 264TCF - 264TS, 265, 2675, 2680, 2685, 2705, 2720, 2725, 273, 274, 274C - 274CF - 254S - 274SK, 275, 275E, 283, 284, 284S, 285, 290, 290E, 293, 294, 294C - 294S, 298, 3050, 3055, 3060, 3065, 3065S, 3070, 3075, 3080, 3085, 3090, 3095, 3115, 3120, 3120T, 3125, 3140, 3210FP - 3210GE - 3210SP, 3220AP - 3220FP - 3220GE, 3220SP, 3225AP - 3225FP - 3225GE, 3225SP, 3235AP - 3235FP - 3235GE, 3235SP, 3315, 3315F/FE - 3315GE - 3315S, 3315V, 3325, 3325F/FE - 3325GE - 3325V, 333, 3330, 3330F/FE - 3330GE - 3330S, 3330V, 3340, 3340F/FE - 3340GE - 3340S, 3340V, 334V, 3350, 3350F/FE - 3350GE - 3350S, 3355, 3355F/FE - 3355GE - 3355S, 340, 342, 35, 350, 352, 353, 353LX - 353S, 354AP - 354AQ, 354F - 354FP - 354FQ - 354GE, 354S - 354SP - 354SQ, 354V - 354VQ, 355, 356CF, 360, 3610, 362, 362N, 363, 3630, 3635, 363LX - 363S, 3645, 364AP - 364AQ - 364CF - 364F, 364FP - 364FQ - 364GE, 364S - 364SP - 364SQ, 364V - 364VQ, 365, 3650, 3655, 3660, 366CF, 367CF, 372, 372N, 373, 373LX - 373S, 374AP - 374AQ - 374F - 374FP, 374FQ - 374GE - 374H - 374S, 374SP - 374SQ - 374V - 374VQ, 375, 375E, 376C - 376CF - 376XCF, 377, 382N, 383, 383LX - 383S, 384AP - 384AQ - 384F - 384FP, 384FQ - 384GE - 384S - 384SP, 384SP - 384V - 384VQ, 387, 390, 390E, 390T, 393, 393LX - 393S - 393TLX, 394AP - 394C - 394F - 394FP, 394FQ - 394GE - 394H - 394S, 394SP - 394SQ - 394TAQ, 396, 396C - 396CF - 396CT, 397, 397T, 398, 399, 4215, 4220, 4225, 4225HV, 4235, 4235HV, 4240, 4245, 4245HV, 4255, 4255HV, 4260, 4265, 4270, 4315, 4320, 4325, 4325HV, 4335, 4335HV, 4345, 4345HV, 4355, 4355HV, 4360, 4365, 4370, 550, 560, 565, 575, 590, 592, 595, 6110, 6120, 6130, 6140, 6150, 6160, 6170, 6180, 6190, 6235, 6235HV, 6245, 6245HV, 6255, 6255HV, 6260, 6265, 6270, 6280, 6290, 65, 675, 690, 698, 698T, 699, 765, 8110, 8120, 8130, 8210, 8220, 825, 835, 865, FE35, TEA20, TED20, TEF20, TEH20	1851095M2, 1851764M1, 828140M1

## TERMOSTATI ADATTABILE

THERMOSTATS ADAPTABLE  
THERMOSTAT ADAPTABLE  
THERMOSTAT PASSEND ZU  
TERMOSTATOS ADAPTABLE



Art./Ref.	Brand	Applicazione/Application	Rif. Orig./Orig. Ref.
09301		1300S, 1300SDT	8829564
09302	FIAT	100.90 - 100.90DT, 1000S, 110.90 - 110.90DT, 115.90 - 115.90DT, 1180, 1280, 130.90 - 130.90DT, 1300S, 1380, 140.90 - 140.90DT, 1580, 1880, 250, 300DT, 420, 440V-DT, 45.66S - 45.66S DT, 450, 470, 470 SP, 474, 50.66S - 50.66S DT, 50.86S V - 50.86S V DT, 50.86V - 50.86V DT, 540S-DT, 55.56 - 55.56 DT, 55.66S - 55.66S DT, 55.86F - 55.86F DT, 55.86S V - 55.86S V DT, 55.86V - 55.86V DT, 55.90 - 55.90 DT, 550, 56.66S - 56.66S DT, 566, 570V-DT, 60.56 - 60.56 DT, 60.66S - 60.66S DT, 60.86F - 60.86F DT, 60.86S V - 60.86S V DT, 60.86V - 60.86V DT, 60.90 - 60.90 DT, 60.93 - 60.93 DT, 60.94 - 60.94 DT, 600DT, 62.86F - 62.86F DT, 640, 65.56 - 65.56 DT, 65.66S - 65.66S DT, 65.90 - 65.90 DT, 65.93 - 65.93 DT, 65.94 - 65.94 DT, 666, 680, 70.56 - 70.56 DT, 70.66S - 70.66S DT, 70.86 V - 70.86 V DT, 70.86S V - 70.86S V DT, 70.90 - 70.90 DT, 72.86 F - 72.86 F DT, 72.86 LP - 72.86 LP DT, 72.93 - 72.93 DT, 72.94 - 72.94 DT, 766, 780, 80.66S - 80.66S DT, 80.90 - 80.90 DT, 82.86 F - 82.86 F DT, 82.86 LP - 82.86 LP DT, 82.93 - 82.93 DT, 82.94 - 82.94 DT, 85.90 - 85.90 DT, 88.93 - 88.93 DT, 88.94 - 88.94 DT, 880S, 90.90 - 90.90 DT, 980, F100 - F100DT, F110 - F110DT, F115 - F115DT, F120 - F120DT, F130 - F130DT, F140 - F140DT	4569187, 4610509, 4610510, 4630916, 4655782, 4674169, 4684390, 4703088, 4703089, 4703624, 4703625, 4823210, 4823211, 4823226, 98463637
09304		650, 650DT, 750, 750DT, 880, 880DT	8812039, 8819129, 8822893, 8826010, 8830331
42042		G170, G190, G210, G240	87800842
42042	CASE	MXM120, MXM130, MXM135, MXM140, MXM150, MXM155, MXM165, MXM175, MXM180, MXM190	87800842, 87803664
09302		3010S, 3300, 3400, 3435, 3500, 3550, 3830, 3935, 4010S, 4030, 4135, 4230, 4430, 4635, 4835, 5010S, 5635, 6635, 7635, 8210, 8430	4569187, 4823210, 4823211, 4823226, 98463637
21762		2000, 2100, 2110, 2120, 2150, 2300, 231, 233, 333, 335, 420, 2310, 2600, 2610, 2810, 2910, 3000, 3100, 3120, 3150, 3190, 3300, 3310, 3400, 3500, 3600, 3610, 3910, 4000, 4100, 4110, 4140, 4190, 4200, 4400, 4450, 4500, 4550, 4600, 4610, 5000, 5100, 5110, 5190, 5200, 5550, 5600, 5610, 5700, 5900, 6410, 6550, 6600, 6610, 6700, 6710, 6810, 7000, 7100, 7410, 7550, 7600, 7610, 7700, 7710, 8000, 8200, 8600, 8700, 9000, 9200, 9600, 9700, DEXA, SUPER DEXA	81805714, 81814071, 81822100, 83913835, C5NE8575D, C9NN8575A, C9NN8575C, D8NN8575AA
21763	FORD	2000, 2100, 2110, 2120, 2150, 2300, 231, 233, 333, 335, 420, 2310, 2600, 2610, 2810, 2910, 3000, 3100, 3120, 3150, 3190, 3300, 3310, 3400, 3500, 3600, 3610, 3910, 4000, 4100, 4110, 4140, 4190, 4200, 4400, 4450, 4500, 4550, 4600, 4610, 5000, 5100, 5110, 5190, 5200, 5550, 5600, 5610, 5700, 5900, 6410, 6550, 6600, 6610, 6700, 6710, 6810, 7000, 7100, 7410, 7550, 7600, 7610, 7700, 7710, 8000, 8200, 8600, 8700, 9200, 9600, 9700, MAJOR, POWER MAJOR, SUPER MAJOR	81859451, 83910123, 83916917, C9NN8575B, D8NN8575CA
21764		2000, 2100, 2110, 2120, 2150, 2300, 231, 233, 333, 335, 420, 2310, 2600, 2610, 2810, 2910, 3000, 3100, 3120, 3150, 3190, 3300, 3310, 3400, 3500, 3600, 3610, 3910, 4000, 4100, 4110, 4140, 4190, 4200, 4400, 4450, 4500, 4550, 4600, 4610, 5000, 5100, 5110, 5190, 5200, 5550, 5600, 5610, 5700, 5900, 6410, 6550, 6600, 6610, 6700, 6710, 6810, 7000, 7100, 7410, 7550, 7600, 7610, 7700, 7710, 8000, 8200, 8600, 8700, 9000, 9200, 9600, 9700	81821482, 83916916, C5NE8575A, C9NN8575A, D8NN8575BA
42042		2310, 2610, 2810, 2910, 3230, 3430, 3930, 4130, 4630, 3610, 3910, 4110, 4610, 4830, 5030, 5610S, 5640, 6610S, 4830N, 4830O, 5030O, 5110, 5610, 5900, 6410, 6610, 6610O, 6640, 6810S, 7740, 7010, 7610S, 6710, 6810, 7410, 7610, 7610O, 7710, 7810, 7810S, 7840, 7910, 8010, 8160, 8210, 8240, 8260, 8340, 8340, 8360, 8530, 8560, 8630, 8670, 8730, 8770, 8830, 8870, 8670A, 8770A, 8870A, 8970, 8970A, TW25, TW30, TW35, TW5, TW10, TW15, TW20	83916340, 87800842, 87802743, 87803664, D8NN8575FB
40549	LANDINI	1000, 10000S, 12500, 13000, 14500, 16000, 16550, 3000/RV, 3000R, 4000/D, 4000R, 4000S, 4500R, 4530F, 4530L, 4530V, 4560F, 4560L, 4560V, 5000/D, 5000/S, 5000R, 5000R-N, 5500, 5530F, 5530L, 5530V, 5560F, 5560L, 5560V, 5830, 5840, 5860, 5870, 6030, 6030F, 6030L, 6030V, 6040, 6500, 6530F, 6530L, 6530V, 6550, 6560F, 6560L, 6560V, 6830, 6840, 6860, 6860V, 6870, 6880, 6880VM, 7500, 7505, 7530F, 7530L, 7550, 7560F, 7560L, 7560V, 7830, 7860, 7860HC, 7870, 7870V, 7880, 7880VM, 8500, 8530F, 8530L, 8530V, 8550, 8560L, 8560V, 8830, 8860, 8860HC, 8870, 8870V, 8880, 8880HC, ADVANTAGE 55F, 55FP, 55GE, ADVANTAGE 55GT, 55GTP, 55L, 55LP, ADVANTAGE 65F, 65FP, 65GE, 65GT, ADVANTAGE 65GTP, 65L, 65LP, ADVANTAGE 75F, 75FP, 75GE, 75GT, ADVANTAGE 75GTP, 75L, 75LP, ADVANTAGE 85F, 85FP, 85GE, 85GT, ADVANTAGE 85GTP, 85L, 85LP, BLIZZARD 50 - 65 - 75 - 85, CINGOLATI: CF5830, CINGOLATI: CF6830, CINGOLATI: C4500, CINGOLATI: C4830, CINGOLATI: C5000, CINGOLATI: C5500, CINGOLATI: C5830, CINGOLATI: C6500, CINGOLATI: C6830, CINGOLATI: C7800, CINGOLATI: C7830, CINGOLATI: C8860, CINGOLATI: CF4830, CINGOLATI: CF5030, CINGOLATI: CF6030, GLOBUS 50, GLOBUS: 50, LEGEND 130BLU - 160BLU, POWER 115BLU-130BLU-160BLU, REX 90GE, TREKKER 50F - 55F - 65F - 70F, TREKKER 75 - 85NG TIER3, TREKKER 75F - 85F, TREKKER 80F, TREKKER 95C, TREKKER C75 - C85, TREKKER CF75 - CF85, VIGNETI 55V, 65V, 75V, VIGNETI FOOTSTEP 65V - 75V	2485635, 2485645, 2485648, 2485653, 2485666



Art./Ref.	Brand	Applicazione/Application	Rif. Orig./Orig. Ref.
40553	LANDINI	3000R - 3000RV, 4560V, 5000 SPECIAL, 5000DT - 5000R - 5000R-N, 5500, 5530F, 5530L, 5530V, 5560F, 5560L, 5560V, 5830, 5840, 5860, 5870, 6030, 6030F, 6030L, 6030V, 6040, 6500, 6530F, 6530L, 6530V, 6550, 6560F, 6560L, 6560V, 6830, 6840, 6860, 6860V, 6870, 6880, 6880VM, 7000 SPECIAL, 7500, 7505, 7530F, 7530L, 7550, 7560F, 7560L, 7830, 7860, 7860HC, 7870, 7870V, 7880, 7880VM, 8500, 8530F, 8530L, 8550, 8560F, 8560L, 8830, 8860, 8870, 8870V, 8880, 8880HC, ADVANTAGE 55F, 55FP, 55GE, ADVANTAGE 55GT, 55GTP, 55L, ADVANTAGE 55LP, 65F, 65FP, ADVANTAGE 65GE, 65GT, 65GTP, ADVANTAGE 65L, 65LP, 75F, 75FP, ADVANTAGE 75GE, 75GT, 75GTP, ADVANTAGE 75L, 75LP, 85F, ADVANTAGE 85FP, 85GE, 85GT, ADVANTAGE 85GTP, 85L, 85LP, BLIZZARD : 50, BLIZZARD : 85, BLIZZARD: 65, BLIZZARD: 75, CINGOLATI : C4500, CINGOLATI : C4830, CINGOLATI : C5000, CINGOLATI : C5500, CINGOLATI : C5830, CINGOLATI : C6830, CINGOLATI : C7800, CINGOLATI : C7830, CINGOLATI : C8860, CINGOLATI : C6500, CINGOLATI : CF 4830, CINGOLATI : CF 5030, CINGOLATI : CF 5830, CINGOLATI : CF 6830, FOOTSTEP 65V - 75V, GLOBUS 50, LARGE 12500 - 14500, LARGE 13000 - 16000 - 16550, LEGEND 130BLU - 160BLU, POWER 115BLU-130BLU-160BLU, REX 90GE, TREKKER 50F - 55F - 65F - 70F, TREKKER 75F - 85F, TREKKER C75 - C85, TREKKER CF75 - CF85, TREKKER NG 80F, TREKKER NH TIER 2 95C, VIGNETI 55V - 65V - 75V	2485644 2485657, 2485659
40558		10000, 10000S, 12500, 13000, 14500, 16000, 16500, 16550, 6060, 6060E, 6060L, 6060V, 6070, 7860, 8860, 9060, 9080, 9080HC, 9500, 9550, 9880, 9880HC, ADVANTAGE 60F, 60FP, 60GE, ADVANTAGE 60GT, 60GTP, 60L, ADVANTAGE 60LP, ADVANTAGE 95GT, L95GT, ATLANTIS 75, ATLANTIS 85, ATLAS: 75, ATLAS: 85, BLIZZARD: 60, BLIZZARD: 95, CF6060, FOOTSTEP 60V, GLOBUS 55 - 60 - 70, LEGEND 115 NG, LEGEND NH TDI 130BLU-160BLU, LEGEND: 105, LEGEND: 115, LEGEND: 130, LEGEND: 145, LEGEND: 165, POWER 115BLU-130BLU-160BLU, REX NEW TIER 295GTP, TREKKER 60F, TREKKER C95, TREKKER CF60, TREKKER NG TIER 3 95, VIGNETI 60V	2485605, 2485613
40549	MASSEY FERGUSON	1004, 1014, 1080, 1085, 1100, 1104, 1105, 1130, 1135, 1200, 122, 130, 133, 134C, 134V, 135, 140, 145, 145S, 145V, 148, 150, 152, 152F, 152S, 152V, 154, 154C, 154F, 154S, 154V, 2205, 230, 233, 234C, 234CF, 234S, 235, 240, 244CF, 245, 25, 250, 250X ADVANCED, 253, 254, 254C, 254CF, 254S, 255, 263T, 264T, 264TCE, 264TS, 265, 265 ADVANCED, 275, 275 ADVANCED, 283, 283 ADVANCED, 290X, 290X ADVANCED, 298, 30, 3210FP, 3210GE, 3210SP, 333, 334V, 340, 342, 35, 350, 352, 353, 353LX, 353S, 354AP, 354AQ, 354F, 354FP, 354FQ, 354GE, 354S, 354SP, 354SQ, 354V, 354VQ, 355, 356CF, 360, 362, 362N, 372N, 382N, 415, 425, 435, 440, 445, 550, 592, 595, 675, 690, 698, 825, 835, TEF20	1446165M91, 828139M1
40553		165, 168, 168F, 168S, 174, 174C, 174F, 174S, 174V, 175, 175S, 178, 184, 184F, 184F, 184S, 185, 188, 194, 194C, 194F, 194S, 265, 273, 274, 274C, 274CF, 274S, 274SK, 275, 275E, 283, 284, 284S, 285, 290, 290E, 294, 294C, 294S, 3220AP, 3220FP, 3220GE, 3220SP, 3225AP, 3225FP, 3225GE, 3225SP, 3235AP, 3235FP, 3235GE, 3235SP, 367CF, 373, 373LX, 373S, 374AP, 374AQ, 374F, 374FP, 374FQ, 374GE, 374H, 374S, 374SP, 374SQ, 374V, 374VQ, 375E, 376C, 376CF, 376XCF, 377, 383, 383LX, 383S, 384AP, 384AQ, 384F, 384FP, 384FQ, 384GE, 384S, 384SP, 384SQ, 384V, 384VQ, 387, 390E, 393, 393LX, 393S, 394AP, 394AQ, 394C, 394F, 394FP, 394FQ, 394GE, 394H, 394S, 394SP, 394SQ, 396C, 396CF, 397, 565, 575, 590, TED20 - TEH20	1446127M91, 826306M1
40558		1004T, 1007, 1014, 1024, 1100, 1104, 1105, 1114, 1130, 1134, 1135, 1200, 1250, 2620, 2625, 2640, 2645, 2675, 2680, 2685, 2705, 2720, 2725, 275E, 290E, 297, 299, 3050, 3055, 3060, 3065, 3065S, 3070, 3075, 3080, 3085, 3090, 3095, 3115, 3120, 3120T, 3125, 3140, 3610, 3630, 3635, 3645, 365, 3650, 3655, 3660, 375, 375E, 390, 390/T, 390E, 393TLX, 394TAQ, 396, 396CT, 397T, 398, 399, 4125, 4225HV, 4235, 4235HV, 4240, 4245, 4245HV, 4255, 4255HV, 4260, 4270, 4360, 4370, 5275, 5285, 5290, 5300, 5310, 5320, 6110, 6120, 6130, 6140, 6150, 6160, 6170, 6180, 6190, 630, 640, 650, 660, 680, 698T, 699, 8110, 8120, 8130	1447384M1
09302	NEW HOLLAND	L60, L65, L75, L85, L95, TD55D, TD60D, TD65D, TD70D, TD60, TD70, TD80, TD90, TD95, TD65F, TD75F, TD85F, TD75D, TD80D, TD85D, TD90D, TD95D, TK100A, TK65F, TK65V, TK70FA, TK70VA, TK75F, TK75FA, TK75M, TK75MA, TK75V, TK75VA, TK76, TK76M, TK80A, TK80MA, TK85, TK85M, TK90A, TK90MA, TK95M, TL70, TL80, TL90, TL100, TN55, TN65, TN70, TN75, TN55D, TN65D, TN70D, TN75D, TN55S, TN65S, TN70S, TN75S, TN55V, TN65V, TN75V, TN60A, TN70A, TN75A, TN60DA, TN70DA, TN75DA, TN60SA, TN70SA, TN75SA, TN60VA, TN70VA, TN75VA, TN95VA, TN65F, TN70F, TN75F, TN65N, TN70F, TN70NA, TN95NA, TN75F, TN75FA, TN75FA, TN85FA, TN95FA, TN75N, TN75NA, TN80F, TN80F, TN90F, TN95F, TN90F, TN95F, TN95F, TN95FA	98463637
42042		75TLB, 95TLB, LB110, LB115 - LB115B, LB115CP, LB75B, LB85, LB90, LB95, M100, M115, M135, M160, TC54 - TC56, TF76, TM110, TM115, TM120, TM125, TM130, TM135, TM140, TM150, TM155, TM165, TM175, TM180, TM190, TR86 - TR87 - TR88 - TR89, TR96 - TR97 - TR98 - TR99, TS100, TS110, TS115, TS80, TS90, TV140, TX62 - TX63 - TX64 - TX65, TX66 - TX67 - TX68	83916340, 87800842, 87802743, 87803664



**POMPE ACQUA ADATTABILE**

POMPEN A EAU ADAPTABLE  
 WATER PUMPS ADAPTABLE  
 WASSERPUMPEN PASSEND ZU  
 BOMBAS DE AGUA ADAPTABLE

**Note:** POMPE ACQUA COMPLETE DI GUARNIZIONI.

**Notes:** WATER PUMPS COMPLETE WITH SEALS.

Art./Ref.	Brand	Applicazione/Application	Rif. Orig./Orig. Ref.	Immagine/Image
10150	CASE	475	3118125R91	
29705		JX100U, JX1060V, JX1095N, JX1095V, JX55, JX65, JX70U, JX75, JX80U, JX85, JX90U	99454833	
40530		C70, C80, C90, CX80, CX90	293515A1, 328361A1	
05686	FIAT	FL4 - FL5 - FD5 - FB7 - FD7, FL7 - FR7 - FR9 - FR10 - FE12, FR12 - FE14 - FE16 - FE18, S60 - FG65A, 100.90 - 100.90DT, 110.90 - 110.90DT, 115.90 - 115.90DT, 130.90 - 130.90DT, 140.90 - 140.90DT, 45.66 - 45.66DT, 45.76V - 45.76V DT, 480, 50.66 - 50.66DT, 55.46 - 55.46DT, 55.66 - 55.66DT, 55.66F - 55.66F DT, 55.66LP - 55.66LP DT, 55.66V - 55.66V DT, 55.76F - 55.76F DT, 55.88 - 55.88DT, 55.90 - 55.90DT, 60.46 - 60.46DT, 60.66 - 60.66DT, 60.66F - 60.66F DT, 60.66LP - 60.66LP DT, 60.76F - 60.76F DT, 60.88 - 60.88DT, 60.90 - 60.90DT, 640, 65.46 - 65.46DT, 65.66 - 65.66DT, 65.88 - 65.88DT, 65.90 - 65.90DT, 70.66 - 70.66DT, 70.66F - 70.66F DT, 70.66LP - 70.66LP DT, 70.66V - 70.66V DT, 70.76F - 70.76F DT, 70.76LP - 70.76LP DT, 70.76V - 70.76V DT, 70.88 - 70.88DT, 70.90 - 70.90DT, 80.66 - 80.66DT, 80.66F - 80.66F DT, 80.76F - 80.76F DT, 80.88 - 88.88DT, 80.90 - 80.90DT, 85.90 - 85.90DT, 90.90 - 90.90DT, F100 - F100DT, F110 - F110DT, F120 - F120DT, F130 - F130DT, TK55.65F, TK55.65M, TK55.65V, TK55.75F, TK55.75M, TK55.75V, TK55.85F, TK55.85M, TK55.85V, TK60.65, TK60.65M, TK60.65V, TK60.75, TK60.75M, TK60.75V, TK60.85F, TK60.85M, TK60.85V, TK70.65, TK70.65M, TK70.75, TK70.75M, TK80.65, TK80.75, TK85.55, TK95.55	4813370, 4784454, 98403015, 98403016, 98497117	
05687		1000, 1000 SUPER, 1000DT, 1000N, 1180, 1180DT, 1280, 1280DT, 1380, 1380DT, 250, 250DT, 255C, 300, 300DT, 300J, 350, 355 C, 400, 400DT, 420, 420DT, 440, 440DT, 446, 446DT, 450, 450DT, 455 SUPER, 455C, 460, 465C, 466, 470, 474, 480, 480.8, 500, 505C, 540, 550, 555C, 565C, 566, 570, 600, 605C, 640, 665C, 666, 670, 765C, 766, 880-3, 980, 980DT	4612675, 4655054, 4679242, 4679303, 82847745, 93191101	
10136		580, 580DT, 680, 680DT, 780, 780DT, 855C	1930925, 4696707, 82847744	
10137		211RB, 215C, 315, 400, 400DT, 411, 411R, 415, 415DT, 421, 431, FL4	566997	
10141		655, SOM650, SOM670, SOM750, SOM800, SOM805C, SOM850	8822883, 8829787	

Art./Ref.	Brand	Applicazione/Application	Rif. Orig./Orig. Ref.	Immagine/Image
15129		SOM35, SOM40, SOM50, SOM511, SOM512, SOM612, SOM615, SOM715	577837	
29705		140.90 - 140.90DT, 45.66S - 45.66S DT, 50.66S - 50.66S DT, 50.86S V - 50.86S V DT, 50.86V - 50.86V DT, 55.56 - 55.56DT, 55.66S - 55.66S DT, 55.86F - 55.86F DT, 55.86S V - 55.86S V DT, 55.86V - 55.86V DT, 56.66S - 56.66S DT, 60.56 - 60.56DT, 60.66S - 60.66S DT, 60.86F - 60.86F DT, 60.86S V - 60.86S V DT, 60.86V - 60.86V DT, 62.86F - 62.86F DT, 65.56 - 65.56DT, 65.66S - 65.66S DT, 70.56 - 70.56DT, 70.66S - 70.66S DT, 70.86S V - 70.86S V DT, 70.86V - 70.86V DT, 72.86F - 72.86F DT, 72.86LP - 72.86LP DT, 80.66S - 80.66S DT, 82.86F - 82.86F DT, 82.86LP - 82.86LP DT	8013363, 99454833	
42999	FIAT	FE16 - FE18 - FA120 - FH120, FL10 - FR10 - FR11 - FE12, FL4 - FD5 - FL5 - FB7 - FD7, FL7 - FR7 - FD9 - FR9 - FD10, FR130 - FH150 - FH200, 100.90 - 100.90DT, 110.90 - 110.90DT, 140.90 - 140.90DT, 45.66S - 45.66S DT, 50.66S - 50.66S DT, 50.86S - 50.86S DT, 50.86V - 50.86V DT, 55.56 - 55.56DT, 55.66 - 55.66 DT, 55.66S - 55.66S DT, 55.86F - 55.86F DT, 55.86S V - 55.86S V DT, 55.86V - 55.86V DT, 56.66S - 56.66S DT, 60.56 - 60.56DT, 60.66S - 60.66S DT, 60.86F - 60.86F DT, 60.86S V - 60.86S V DT, 60.86V - 60.86V DT, 60.93 - 60.93DT, 60.94 - 60.94DT, 62.86F - 62.86F DT, 65.56 - 65.56DT, 65.66S - 65.66S DT, 65.90 - 65.90DT, 65.93 - 65.93DT, 65.94 - 65.94DT, 70.56 - 70.56DT, 70.66S - 70.66S DT, 70.86S V - 70.86S V DT, 70.86V - 70.86V DT, 70.90 - 70.90DT, 72.86F - 72.86F DT, 72.86LP - 72.86LP DT, 72.93 - 72.93DT, 72.94 - 72.94DT, 80.66S - 80.66S DT, 80.90 - 80.90DT, 82.86LP - 82.86LP DT, 82.93 - 82.93DT, 82.94 - 82.94DT, 85.90 - 85.90DT, 88.93 - 88.93DT, 88.94 - 88.94DT, F100 - F100DT, F110 - F110DT, F115 - F115DT, F120 - F120DT, F130 - F130DT, F140 - F140DT, TK100.55, TK55.85F, TK55.85M, TK55.85V, TK60.85F, TK60.85V, TK62.85, TK62.85M, TK75.85, TK75.85M, TK82.85M, TK88.85M	98497117	
10145		MAJOR, POWER MAJOR, SUPER MAJOR, TRADER 590E, TRADER 592E	81411996, 81711727, 81711728, 82847510, E1ADKN8501A, E1ADKN8501B, E1ADKN8501C	
21827		231, 2310, 233, 2600, 2610, 2810, 2910, 333, 335, 3600, 3610, 3900, 4100, 4110, 420, 4550, 4600, 4610, 5110 (<10/88), 5600, 5610 (<10/88), 5700, 5900 (<10/88), 6550, 6600, 6610 (<10/88), 6700, 6710 (<10/88), 7550, 7600, 7610 (<10/88), 7700, 7710 (<10/88)	81872285, 81876233, 83943913, 83956717, 87800118, D8NN8501TC, E6NN8501CA, E6NN8501CB, E6NN8501GD	
29705		3010S, 3435, 3830, 3935, 4030, 4135, 4230, 4430, 4635, 4835, 5635, 6635, 7635, 8430	99454833	
36197	FORD	2000, 2100, 2110, 2120, 2150, 2190, 2300, 231, 2310, 233, 2600, 2610, 2810, 2910, 3000, 3100, 3120, 3150, 3190, 3230, 3300, 3310, 333, 335, 3400, 3430, 3500, 3600, 3610, 3900, 3930, 4000, 4100, 4110, 4130, 4140, 4190, 420, 4200, 4400, 4450, 4500, 4550, 4600, 4610, 4630, 4830 (<10/88), 5000, 5030 (<10/88), 5110 (<10/88), 5600, 5610 (<10/88), 5700, 5900 (<10/88), 6550, 655D, 6600, 6610 (<10/88), 6700, 6710 (<10/88), 7000, 7100, 7550, 7600, 7700, 7710 (<10/88)	81814205, 81838685, 81863898, 82845215, 83905629, 83912465, 83914023, 83914192, 83919542, 83919560, 83926000, 83926002, 83943914, EAPN8A513F	
40527		DEXTA, SUPER DEXTA	81718104, 957E8501B	
41897		5110 (>11/88), 5610 (>11/88), 6410 (WITH VISCOUS FANS), 6610 (>11/88), 6710 (>11/88), 6810 (>11/88), 7610 (>11/88), 7710 (>11/88)	81863830, 81872289, 83964037, 83964046, 87800123, E7NN8501FB, E7NN8501FE, EJPN8A513FB, FAPN8A513AA	

Art./Ref.	Brand	Applicazione/Application	Rif. Orig./Orig. Ref.	Immagine/Image
41963	FORD	9000, 9200, 9600	83912463, DHPN8A513A	
42999		3010S, 3435 (<C3540), 3830, 3935 (<C3540), 4010S, 4030, 4135 (<C3540), 4230, 4430, 5010S, 8430	98497117	
10150	LANDINI	6500, 6530F, 6530L, 6550, 6560F, 6560L, 6560V, 6830, 6830V, 6840, 6860, 6860V, 6870, 6880, 6880VM, 7000 SPECIAL, 7500, 7505, 7530F, 7530L, 7550, 7560F, 7560L, 7830, 7860, 7860HC, 7870, 7880, 7880VM, 8500, 8530F, 8530L, 8550, 8560F, 8560L, 8830, 8860, 8860HC, 8870, 8880, 8880HC, ADVANTAGE 65F - 65FP - 65GE, ADVANTAGE 65GT - 65GTP - 65L, ADVANTAGE 65LP - 75F - 75FP, ADVANTAGE 75GE - 75GT - 75GTP, ADVANTAGE 75L - 75LP - 85F, ADVANTAGE 85FP - 85GE - 85GT, ADVANTAGE 85GTP - 85L - 85LP, BLIZZARD : 85, BLIZZARD : 65, BLIZZARD : 75, CINGOLATI : C6500, CINGOLATI : C6830, CINGOLATI : C7800, CINGOLATI : C7830, CINGOLATI : C8860, CINGOLATI : CF 6830, TREKKER 65F - 70F - 75F - 85F, TREKKER : C75, TREKKER : C85, TREKKER : CF75, TREKKER : CF85, TREKKER NG 80F, VIGNETI CAB E F.S.: 75V, VIGNETI CAB E F.S.: 65V, VIGNETI FOOTSTEP 65V - 75V	4131A008, 4131A011, 4131A013, 4131A021, 4131A025, 4131A027, 4131A029, 4131A032, 4131A034	
10151		10000, 9500	41312681, 41312703, 41312749, 41312806, 41312807, 41313075	
10153		10000, 10000S, 12500, 13000, 14500, 16000, 16500, 9500	41313027, 41313058, 41313079	
10159		10000, 9500	3641861M91, 41312557, 41313018, 41313045	
10161		4000S, 4530V, 4560V, 5000DT, 5500, 5530F, 5530L, 5530V, 5560F, 5560L, 5560V, 5830, 5840, 5860, 5870, 6030, 6040, ADVANTAGE 55F - 55FP - 55GE, ADVANTAGE 55GT - 55GTP, ADVANTAGE 55L - 55LP, BLIZZARD : 50, CINGOLATI : CF5830, CINGOLATI : C4500, CINGOLATI : C4830, CINGOLATI : C5500, CINGOLATI : C5830, CINGOLATI : CF4830, CINGOLATI : CF5030, CINGOLATI : CF6030, GLOBUS : 50, TREKKER 50F - 55F, TREKKER CF55, VIGNETI CAB E FOOT STEP : 55V	41312161, 41312214, 41312309, 41312357, 41312488, 41312489, 41312504, 41312505, 41312576, 41312589, 41312591, 41312744, 41312768, 41312783, 41312785, 41312786, 41312874, 41312963, 41312964, 41312966, 41312967, 41313403	
40520		5000DT	41312055, 41312154, 41312494, 41312784	

Art./Ref.	Brand	Applicazione/Application	Rif. Orig./Orig. Ref.	Immagine/Image
40522		4000 SPECIAL, 4530V, 4560V, 5000DT, 5500, 5530F, 5530L, 5530V, 5560F, 5560L, 5560V, 5830, 5840, 5860, 5870, ADVANTAGE 55F - 55FP - 55GE, ADVANTAGE 55GT - 55GTP - 55L, ADVANTAGE 55LP - 55V, BLIZZARD 50, C4500, C4830, C5500, C5830, CF4830, CF5030, CF5830, GLOBUS 50, TREKKER 50F - 55F, TREKKER CF55	41312159, 41312416, 41312487, 41312495	
40526		6500, 6505, C6000, PRIMA 6000 - 6000 SPECIAL, PRIMA 7000 SPECIAL	41312965, 41312978, 41313458, 41317006, U5MW0010, U5MW0055, U5MW0061, U5MW0089	
40527	LANDINI	4530V, 4560V, 5500, 5530F, 5530L, 5530V, 5560F, 5560L, 5560V, 5830, 5840, 5860, 5870, 6030, 6040, ADVANTAGE 55F - 55FP - 55GE, ADVANTAGE 55GT - 55GTP, ADVANTAGE 55L - 55LP, BLIZZARD 50, C4500, C4830, C5500, C5830, C6030F, CF4830, CF5030, CF5830, GLOBUS 50, PRIMA 3000R - 3000RV, PRIMA 4000 SPECIAL, PRIMA 5000DT - 5000R-N, PRIMA 5000R-S - 5000 SPECIAL, TREKKER 50F - 55F, TREKKER CF55, VIGNETI 55V, VIGNETI FOOTSTEP 95V	U5MW0057, U5MW0096	
40530		9060, 9080 - 9080HC, 9880 - 9880HC, ADVANTAGE L95GT, BLIZZARD 95, TREKKER C95	41313218, 41313227, 41313237, 41313243, 41313245, 41313252, 41313261	
05686		3300 - 3300R, 3400, 3500 - 3500R, 3550 - 3550R - 3550AL, 3650 - 3650R, 3750 - 3750R	4813370	
05687		3350, 3450, 3600, M112	93191101	
10154	LAVERDA	3900	4764156	
10155		MX 240, MX 240 R	4606023	

Art./Ref.	Brand	Applicazione/Application	Rif. Orig./Orig. Ref.	Immagine/Image
10156		MX 300, MX 300 R	4710552	
10157		3700, 3790, 3790 R	4796537	
10158		M 150, M 152	8829779	
10159	LAVERDA	M120, M132	41313045	
10160		M 120, M 132	41313047	
29705		3550AL - 3560AL, L518 - L520	99454833	
42999		3550AL, L517	98497117	
10150		MASSEY FERGUSON	165, 168, 168F, 168S, 174, 174C, 174F, 174S, 174V, 175, 175S, 178, 184, 184F, 184S, 185, 188, 194, 194C, 194F, 194S, 255, 265, 273, 274, 274C, 274CF, 274S, 274SK, 275, 275E, 283, 284, 284S, 285, 290, 290E, 293, 294, 294C, 294S, 3220AP, 3220FP, 3220GE, 3220SP, 3225AP, 3225FP, 3225GE, 3225SP, 3235FP, 3235GE, 3235SP, 362, 362N, 367CF, 372N, 373, 373LX, 373S, 374AP, 374AQ, 374F, 374FP, 374FQ, 374H, 374S, 374SP, 374SQ, 374V, 374VQ, 375E, 376C, 376CF, 376XCF, 377, 382N, 383, 383LX, 383S, 384AP, 384AQ, 384F, 384FP, 384FQ, 384GE, 384S, 384SP, 384SQ, 384V, 384VQ, 387, 390E, 393, 393LX, 393S, 394AP, 394AQ, 394C, 394F, 394FP, 394FQ, 394GE, 394H, 394S, 394SP, 394SQ, 396C, 396CF, 396CT, 397, 565, 575, 590, 675, 690	3637411M91, 3640565M91, 3641219M91, 3641832M91, 4131A008, 4131A011, 4131A013, 4131A021, 4131A025, 4131A027, 4131A029, 4131A032, 4131A034
10151	1014, 1100, 1104, 1105, 1135, 1200		3641365M91, 41312681, 41312703, 41312749, 41312806, 41312807, 41313075, 4222123M91, 4224118M91, 747611M91	

Art./Ref.	Brand	Applicazione/Application	Rif. Orig./Orig. Ref.	Immagine/Image
10152	MASSEY FERGUSON	1004, 1080, 1085, 298, 592, 595, 698	3641364M91, 3641887M91, 41312419, 41312747, 41312828, 41313269, 747446M91	
10153		1014, 1024, 1114, 1134, 2620, 2625, 2640, 2645, 2680, 2685, 2720, 2725, 3080, 3090, 3610, 3630, 3650, 399, 699	3641355M91, 3641859M91, 3641880M91, 41313027, 41313058, 41313079	
10159		500, 507, 510, 515, 520, 525	3641310M91, 3641310R91, 3641861M91, 41312557, 41313018, 41313045	
10160		1250, 24 - 27 - 29 - 29XP, 31 - 31XP -, 530 - 530S, 535, 750, 800 - 805 - 810 - 815	3637466M91, 3638990M91, 3638994M91, 3641314M91, 3641886M91, 41313010, 41313025, 41313033, 41313047, 41313049, 41313059, 41313062, 41313065, 747570M91	
10161		133, 134C, 134V, 135, 135V, 140, 145, 145S, 145V, 148, 150, 152, 152F, 152S, 152V, 154, 154C, 154F, 154S, 154V, 164TF, 164TS, 164TV, 220S, 230, 233, 234C, 234CF, 234S, 235, 240, 244CF, 245, 250, 250X - 250X ADVANCED, 253, 254, 254C, 254CF, 254S, 255, 263T, 264T, 264TCF, 264TS, 3210FP, 3210GE, 3210SP, 333, 334V, 340, 342, 35, 350, 352, 353, 353LX, 353S, 354AP, 354AQ, 354F, 354FP, 354FQ, 354GE, 354S, 354SP, 354SQ, 354V, 354VQ, 355, 356CF, 360, 415, 550	3641338M91, 3641823M91, 41312161, 41312214, 41312309, 41312357, 41312488, 41312489, 41312504, 41312505, 41312576, 41312589, 41312591, 41312744, 41312768, 41312783, 41312785, 41312786, 41312874, 41312963, 41312964, 41312966, 41312967, 41313403, 747542M91	
40517		135, 35, 835, FE35, TEA20, TED20, TEF20, TEH20	1810369M91, 1881805M91, 1885489M92, 825843M91, 826119M91, 830862M91	
40520		135, 140, 145, 145S, 145V, 203, 205, 2135, 35	41312055, 41312154, 41312494, 41312784	
40522		133, 134C, 134V, 135, 135V, 145, 145S, 145V, 148, 150, 152, 152F, 152S, 152V, 154, 154C, 154F, 154S, 154V, 164TF, 164TS, 164TV, 220S, 230, 233, 234C, 234CF, 234S, 235, 240, 244CF, 245, 250, 253, 254, 254C, 254CF, 254S, 255, 263T, 264T, 264TCF, 264TS, 3210FP, 3210GE, 3210SP, 333, 334V, 340, 342, 350, 352, 353, 353LX, 353S, 354AP, 354AQ, 354F, 354FP, 354FQ, 354GE, 354S, 354SP, 354SQ, 354V, 354VQ, 355, 356CF, 360, 550	41312159, 41312416, 41312487, 41312495	

Art./Ref.	Brand	Applicazione/Application	Rif. Orig./Orig. Ref.	Immagine/Image
40526		155, 158, 158F, 158S, 158V, 165, 260, 560, 65, 765, 865	3637372M91, 3641250M91, 41312965, 41312978, 41313458, 41317006, U5MW0010, U5MW0055, U5MW0061, U5MW0089	
40530	MASSEY FERGUSON	1004T, 1007, 3050, 3055, 3060, 3065, 3065S, 3070, 3075, 365, 375, 390 - 390T, 393TLX, 394TAQ, 396CT, 397T, 398, 4225 - 4225HV, 4235 - 4235HV, 4240, 4245 - 4245HV, 4255 - 4255HV, 5275, 5285, 5290, 5300, 5310, 6110, 6120, 6130, 6140, 6150, 698T	3637468M91, 3638998M91, 3638999M91, 3641035M91, 3641263M91, 41313218, 41313227, 41313237, 41313243, 41313245, 41313252, 41313261, 4222002M91	
40532		285, 298	3641363M91	
40543		29 - 29XP - 31 - 31XP, 560, 565, 660, 665, 750, 760, 820, 825, 830, 835, 840, 845, 850, 855, 860	3637467M91, 41313048, 4222001M91	
29705	NEW HOLLAND	L60, L65, L75, L85, L95, TD55D - 7TD65D - 7D75D, TD85D - 7TD95D, TK100.55, TK55.85F, TK55.85M, TK55.85V, TK60.85F, TK60.85V, TK62.85, TK62.85M, TK65F, TK65V, TK72.85, TK72.85M, TK75F, TK75M, TK75V, TK76, TK76M, TK82.85M, TK85, TK85M, TK88.85M, TK95M, TL65 - TL70 - TL80, TL90 - TL100, TN55 - TN65 - TN70 - TN75, TN55D - TN65D - TN70D - TN75D, TN55S - TN65S - TN70S - TN75S, TN55V - TN65V - TN75V, TN60VA - TN95VA, TN65F - TN70F - TN75F, TN65N, TN75N, TN80F - TN90F - TN95F, TN95NA	99454833	
10150	PERKINS	A4.212, A4.236, A4.248, AT4.236, AT4.236	4131A008, 4131A011, 4131A013, 4131A021, 4131A025, 4131A027, 4131A029, 4131A032, 4131A034, U5MW0064, U5MW0104, U7LW0032, U7LW0054, U7LW0068, U7LW0085, U7LW0100	
10151		A6.354, A6.354.1, A6.354.4, AT6.354, AT6.354.1	41312681, 41312703, 41312749, 41312806, 41312807, 41313075, U5MW0018, U5MW0183	
10152		A4.318, A4.318.2	41312419, 41312747, 41312828, 41313269, U5MW0014, U5MW0147	

Art./Ref.	Brand	Applicazione/Application	Rif. Orig./Orig. Ref.	Immagine/Image
10153	PERKINS	A6.354.1, A6.354.4, AT6.354.4	41313027, 41313058, 41313079, U5MW0133	
10159		MOTORI 6.354 E 6.372	41312557, 41313018, 41313045, U5MW0111	
10160		A6.354.4, AT6.354.4	41313010, 41313025, 41313033, 41313047, 41313049, 41313059, 41313062, 41313065, U5MW0129	
10161		A3.144, A3.152, AD3.152, AG3.152, AT3.152.4	41312161, 41312214, 41312309, 41312357, 41312488, 41312489, 41312504, 41312505, 41312576, 41312589, 41312591, 41312744, 41312768, 41312783, 41312785, 41312786, 41312874, 41312963, 41312964, 41312966, 41312967, 41313403, U5MW0023, U5MW0097	
40520		A3.144, A3.152, AD3.152	41312055, 41312154, 41312494, 41312784	
40522		A3.144, AD3.152, AG3.152, AT3.152.4, AT4.236	41312159, 41312416, 41312487, 41312495	
40526		A4.192, A4.203, A4.236, AD4.203	41312965, 41312978, 41313458, 41317006, U5MW0010, U5MW0055, U5MW0061, U5MW0089	
40527		APPLICAZIONI DIVERSE AGRICOLE, APPLICAZIONI DIVERSE INDUSTRIA	U5MW0057, U5MW0096	



Art./Ref.	Brand	Applicazione/Application	Rif. Orig./Orig. Ref.	Immagine/Image
40530		A4.236, A4.248, AT4.236, T4.236	41313218, 41313227, 41313237, 41313243, 41313245, 41313252, 41313261, U5MW0095, U5MW0105, U5MW0108	
40532	PERKINS	A4.318, A4.318.2	41313272, U5MW0009	
40543		AT6.354.4	41313048, U5MW00132	

**POMPE ACQUA ALTA QUALITÀ**

POMPES À EAU HAUTE QUALITÉ  
 WATER PUMPS HIGH QUALITY  
 WASSERPUMPEN HOHER QUALITÄT  
 BOMBAS DE AGUA DE ALTA CALIDAD

**Note:** POMPE ACQUA ALTA QUALITÀ COMPLETE DI GUARNIZIONI.  
**Notes:** WATER PUMPS HIGH QUALITY COMPLETE WITH SEALS.

Art./Ref.	Descrizione estesa/Descrizione estesa	Note/Note	Immagine/Image
05686TOP	Pompa acqua adattabile al rif. Fiat 4813370 ad alta qualità	Riferimenti originali e applicazioni vedere codice ama 05686	
05687TOP	Pompa acqua adattabile al rif. Fiat 4679242 ad alta qualità	Riferimenti originali e applicazioni vedere codice ama 05687	
10150TOP	Pompa acqua adattabile al rif. Perkins U5MW0104 ad alta qualità	Riferimenti originali e applicazioni vedere codice ama 10150	
10161TOP	Pompa acqua adattabile al rif. Perkins U5MW0097 ad alta qualità	Riferimenti originali e applicazioni vedere codice ama 10161	
29705TOP	Pompa acqua adattabile al rif. Fiat 99454833 ad alta qualità	Riferimenti originali e applicazioni vedere codice ama 29705	
42999TOP	Pompa acqua adattabile al rif. Fiat 98497117 ad alta qualità	Riferimenti originali e applicazioni vedere codice ama 42999	

**KIT GUARNIZIONI PER POMPE ACQUA**

SEALS KIT POUR POMPES À EAU

GASKET KIT FOR WATER PUMP

SEALS KIT FÜR WASSERPUMPEN

KIT DE JUNTAS PARA BOMBAS DE AGUA



Art./Ref.	Descrizione estesa/Descrizione estesa
85601	Kit guarnizioni per pompe acqua codice AMA 05687 e 05687TOP (FIAT 4679242)
85602	Kit guarnizioni per pompe acqua codice AMA 05686 e 05686TOP (FIAT 4813370)
85603	Kit guarnizioni per pompe acqua codice AMA 42999 e 42999TOP (FIAT 98497117)
85604	Kit guarnizioni per pompe acqua codice AMA 29705 e 29705TOP (FIAT 99454833)
85605	Kit guarnizioni per pompe acqua codice AMA 10150 e 10150TOP (LANDINI U5MW0104)
85606	Kit guarnizioni per pompe acqua codice AMA 10161 e 10161TOP (LANDINI U5MW0097)

**GUARNIZIONI POMPE ACQUA ADATTABILI**

SEALS EAU POMPES ADAPTABLE

SEALS WATER PUMPS ADAPTABLE

SEALS WASSERPUMPEN PASSEND ZU

SELLOS DE AGUA BOMBAS ADAPTABLE

Art./Ref.	Brand	Applicazione/Application	Rif. Orig./Orig. Ref.	Immagine/Image
12970	BRAUD	1620 - 1620S	4848840	
14190		1620, SERIE SB	98418621	
14606		1620 - 1620S, SERIE SB	98400776	
16809		SB65	14457780	
29507		SB52 - SB54	14457880	

Art./Ref.	Brand	Applicazione/Application	Rif. Orig./Orig. Ref.	Immagine/Image
12970		100.90 - 100.90 DT, 110.90 - 110.90 DT, 115.90 - 115.90 DT, 130.90 - 130.90 DT, 140.90 - 140.90 DT, 45.66 - 45.66 DT, 45.76 V, 50.66 - 50.66 DT, 50.86 V - 50.86 V DT, 50.86S V DT - 50.86S V DT, 55.56 - 55.56 DT, 55.66 - 55.66 DT, 55.75 F-M-V, 55.76 F - 55.76 F DT, 55.76 V - 55.76 V DT, 55.86 F - 55.86 F DT, 55.86 V DT - 55.86 V DT, 55.86S V DT - 55.86S V DT, 55.88 - 55.88 DT, 55.90 - 55.90 DT, 60.56 DT, 60.66 - 60.66 DT, 60.66 F - 60.66 F DT, 60.66 LP - 60.66 LP DT, 60.75 M-V, 60.76 F - 60.76 F DT, 60.86 F - 60.86 F DT, 60.86 V - 60.86 V DT, 60.86S V DT - 60.86S V DT, 60.88 - 60.88 DT, 60.90 - 60.90 DT, 62.86 F - 62.86 F DT, 65.56 - 65.56 DT, 65.66 - 65.66 DT, 65.88 - 65.88 DT, 65.90 - 65.90 DT, 70.56 - 70.56 DT, 70.66 - 70.66 DT, 70.66 F - 70.66 F DT, 70.66 LP - 70.66 LP DT, 70.66 V, 70.75 M, 70.76 F - 70.76 F DT, 70.76 LP - 70.76 LP DT, 70.76 V, 70.86 V - 70.86 V DT, 70.86S V DT - 70.86S V DT, 70.88 - 70.88 DT, 70.90 - 70.90 DT, 72.86 F - 72.86 F DT, 72.86 LP - 72.86 LP DT, 80.66 - 80.66 DT, 80.75, 80.76 F - 80.76 F DT, 80.88 - 80.88 DT, 80.90 - 80.90 DT, 82.86 F - 82.86 F DT, 82.86 LP - 82.86 LP DT, 85.90 - 85.90 DT, 90.90 - 90.90 DT	14462882, 4770435, 4848840	
14053		100.55, 100.90, 110.90, 115.90, 130.90, 140.90, 45.66, 50.66, 250, 350, 300, 420, 450, 466, 480, 500, 540, 480S, 500S, 540S, 605C-S, 55.46, 55.56, 55.66, 566, 580, 640, 780, 766, 880/S, 680, 880S, 1000S, 980, 1000, 1180, 1280, 1380	4673810	
14190		100.55C, 100.90, 100.90DT, 1000, 1000S, 110.90, 110.90DT, 115.90, 1180, 1280, 130.90, 1380, 140.90, 250, 300, 350, 420, 45.66, 450, 466, 480, 480S, 500S, 540S, 605C-S, 50.66, 50.66S, 500, 540, 55.46, 55.56, 55.66, 566, 580, 60.66S, 60.90, 640, 680, 70.66S, 766, 780, 80.66, 80.90, 880S, 980, F100, F115, F120, F130, F140	4599562, 4852556, 4854716, 98418621	
14606	FIAT	100.90 - 100.90DT, 1000S, 880S, 980, 1180, 1280, 110.90 - 110.90DT, 1380, 140.90 - 140.90DT, 250, 300, 350, 420, 480S, 500S, 540S, 605C-S, 50.66 - 50.66DT, 55.56 - 55.56DT, 55.66 - 55.66DT, 55.88 - 55.88DT, 55.90 - 55.90DT, 60.56 - 60.56DT, 60.66 - 60.66DT, 60.88 - 60.88DT, 60.90 - 60.90DT, 60.93 - 60.93DT, 60.94 - 60.94DT, 640, 580, 680, 780, 65.56 - 65.56DT, 65.66 - 65.66DT, 65.88 - 65.88DT, 65.90 - 65.90DT, 65.93 - 65.93DT, 65.94 - 65.94DT, 70.56 - 70.56DT, 70.66 - 70.66DT, 70.66S - 70.66S DT, 70.88 - 70.88DT, 70.90 - 70.90DT, 72.93 - 72.93DT, 72.94 - 72.94DT, 80.66 - 80.66DT, 80.66S - 80.66S DT, 80.88 - 80.88DT, 80.90 - 80.90DT, 82.93 - 82.93DT, 82.94 - 82.94DT, 85.90 - 85.90DT, 88.93 - 88.93DT, 88.94 - 88.94DT, 90.90 - 90.90DT, F100, F115, F120, F130, F140, F110 - F110DT	4599561, 4858073, 98400776	
16809		55.66 DT, 60.93 DT - 60.94 DT, 65.93 DT - 65.94 DT, 72.93 DT - 72.94 DT, 82.93 DT - 82.94 DT, 88.93 DT - 88.94 DT	14457780, 5135740, 583198	
29507		100.55, 100.90 - 100.90 DT, 110.90 - 110.90 DT, 140.90 - 140.90 DT, 45.66 - 45.66 DT, 45.76 V, 50.66 - 50.66 DT, 55.56 - 55.56 DT, 55.65 F-M-V, 55.66 - 55.66 DT, 55.75 F-M-V, 55.76 F - 55.76 F DT, 55.76 V - 55.76 V DT, 55.85 F-M-V, 55.88 - 55.88 DT, 60.56 DT, 60.65 M-V, 60.66 - 60.66 DT, 60.75 M-V, 60.76 F - 60.76 F DT, 60.85 F-V, 60.88 - 60.88 DT, 60.93 - 60.93 DT, 60.94 - 60.94 DT, 62.85 M, 65.56 - 65.56 DT, 65.66 - 65.66 DT, 65.88 - 65.88 DT, 65.90 - 65.90 DT, 65.93 - 65.93 DT, 65.94 - 65.94 DT, 70.56 - 70.56 DT, 70.65 M, 70.66 - 70.66 DT, 70.75 M, 70.76 LP - 70.76 LP DT, 70.76 V, 70.76 F - 70.76 F DT, 70.88 - 70.88 DT, 70.90 - 70.90 DT, 72.85 M, 72.93 - 72.93 DT, 72.94 - 72.94 DT, 80.65, 80.66 - 80.66 DT, 80.75, 80.76 F - 80.76 F DT, 80.88 - 80.88 DT, 80.98 - 80.98 DT, 82.85 M, 82.93 - 82.93 DT, 82.94 - 82.94 DT, 85.55, 85.98 - 85.90 DT, 88.85 M, 88.93 - 88.93 DT, 88.94 - 88.94 DT, 90.90 - 90.90 DT, 95.55, F100 - F100 DT, F110 - F110 DT, F115 - F115 DT, F120 - F120 DT, F130 - F130 DT, F140 - F140 DT	14457880, 350358153, 44004518, 79040133, 98458443	
12970		3830 - 4030 - 4230 - 4430	4848840	
14190	FORD	3010S, 3435, 3830, 3935, 4010S, 4030, 4135, 4230, 4430, 4635, 4835, 5010S, 5635, 6635, 7635, 8430	98418621	

Art./Ref.	Brand	Applicazione/Application	Rif. Orig./Orig. Ref.	Immagine/Image
14606	FORD	3010S, 3435, 3830, 3935, 4010S, 4030, 4135, 4230, 4430, 4635, 4835, 5010S, 5635, 6635, 7635, 8430	98400776	
29507		3010S - 4010S, 4635 - 4835, 5010S, 5635, 6635, 7635, 8430	14457880	
12970	LAVERDA	3300AL, 3400 - 3400R, 3550AL, 3650 - 3650R, 3750 - 3750R	4848840	
14053		3300AL	4673810	
14190		3400, 3550, 3560, 3650, 3750, L517	98418621	
14606		3400 - 3400R, 3550AL - 3650AL, 3650 - 3650R, 3750 - 3750R, L517 - L518 - L520	98400776	
16809		3500 - 3550 - 3550AR - 3560AL, L517 - L521, L523 INTEGRALE - L523 MCS, L524, L525 INTEGRALE - L525 MCS, L624 - L625 - L626, L627 INTEGRALE - L627 MCS, TL58 I	14457780	
29507		3400 - 3400R - 3550AL, MX240 - MX240R, MX300 - MX300R	14457880	
14190		L60, L65, L75, L85, L95, LB75, SERIE, SERIE TN, TNA, TND, TNF, TNS, TNSA, SERIE TNV, TNVA, TELESCOPICO/TELEHANDLER LM, TL70,	98418621	
14606	NEW HOLLAND	SERIE L, SERIE TD - TDD - TDF, SERIE TK, SERIE TL, SERIE TT, SERIE-TN, SERIE-TNN, SERIE-TND, SERIE-TNS, SERIE-TNF, SERIE-TNDA, SERIE-TNFA, SERIE-TNNA, SERIE-TNA,, SERIE-TNSA, SERIE-TNVA	98400776	
16809		T4020 - T4030 - T4040 - T4050, T6010 - T6020 - T6030 - T6040, T6050 - T6060 - T6070, T7030 - T7040 - T7050 - T7060, TD55D - TD60D, TD65B, TD65D - TD70D - TD75D, TD80D - TD85D - TD90D - TD95D, TL100 - TL100A, TL60 - TL60E - TL65, TL70 - TL70A, TL75 - TL75E, TL80 - TL80A, TL85 - TL85E, TL90 - TL90A, TL95 - TL95E, TN60DA - TN70DA - TN75DA, TN85DA - TN85SA - TN95DA, VL5060 - VL5070, VL5080 - VL5090, VL530 - VL540 - VL550 - VL570, VM3080 - VM3080 AL, VM3090, VM340 - VM370, VN2090, VN240 - VN260 - VN300	14457780	

Art./Ref.	Brand	Applicazione/Application	Rif. Orig./Orig. Ref.	Immagine/Image
29507	NEW HOLLAND	L60 - L65 - L75 - L85 - L95, T4020 - T4020V, T4030 - T4030F, T4030N - T4030V, T4040 - T4020F, T4040N - T4040V, T4050 - T4050F, T4050N - T4050V, T5030 - T5040 - T5050, T5060 - T5070, T7.220 - T7.235 - T7.250, T7.260 - T7.270, T7030 - T7040 - T7050, T7060 - T7070, TK100A, TK4020F - TK4020V, TK4030 - TK4030F - TK4030V, TK4040 - TK4040M, TK4050 - TK4050M, TK4060, TK65F - TK65V, TK70FA - TK70VA, TK75F - TK75FA, TK75M - TK75MA, TK75V - TK75VA, TK76 - TK76M, TK80A - TK80MA, TK85 - TK85M, TK90A - TK90MA, TK95M, TL100 - TL100A, TL65 - TL70 - TL70A, TL80 - TL80A - TL90 - TL90A, TM115 - TM120 - TM125, TM130 - TM135 - TM140, TM150 - TM155 - TM165 - TM180, TM7010 - TM7020, TM7030 - TM7040, TN55D - TN55S - TN55V, TN60DA - TN60SA - TN60VA, TN65D - TN65F - TN65N, TN65S - TN65V, TN70D - TN70DA, TN70F - TN70NA, TN70S - TN70SA - TN70VA, TN75D - TN75DA, TN75F - TN75FA, TN75N - TN75NA, TN75S - TN75SA, TN75V - TN75VA, TN80F, TN85DA - TN85FA - TN85SA, TN90F, TN95DA, TN95F - TN95FA, TN95NA - TN95VA	14457880	

**PULEGGE PER POMPE ACQUA ADATTABILI**

POULIE POUR POMPES A EAU ADAPTABLE  
 PULLEYS FOR WATER PUMPS ADAPTABLE  
 SCHEIBE FUER WASSERPUMPE PASSEND ZU  
 POLEA PARA BOMBA AGUA ADAPTABLE



Art./Ref.	Brand	Applicazione/Application	Rif. Orig./Orig. Ref.
37021	FIAT - FORD	60.66,80.66,60.76,80.76,55.86, 62.86,72.86,82.86, L60,L65,L75,L85,L95, SERIE DIAMANTE, SERIE ORO, 3435, 3830, 3935, 4030, 4135, 4430	4615467, 4736987, 4655014, E0558005MD15
40319	LANDINI - MASSEY FERGUSON	4000S, 5500, 5830, 5840, 5860, 5870, 6030, 6040, 6060, 6070, ADVANTAGE CAB E FOOT STEP: 55, ADVANTAGE CAB E FOOT STEP: 60, BLIZZARD: 50, BLIZZARD: 60, CINGOLATI: CF5830, CINGOLATI: C4500, CINGOLATI: C4830, CINGOLATI: C5000, CINGOLATI: C5500, CINGOLATI: C5830, CINGOLATI: CF4830, CINGOLATI: CF5030, CINGOLATI: CF6030, CINGOLATI: CF6060, FRUTTETI 530F/L/V: 6030, FRUTTETI 560 F/L/V: 4560, FRUTTETI 560 F/L/V: 5560, FRUTTETI 560F/L/V: 6060, FRUTTETI: 530F/L/V: 4530, FRUTTETI: 530F/L/V: 5530, GLOBUS: 50, TREKKER: CF55, TREKKER: CF60, VIGNETI CAB E FOOT STEP: 55V, VIGNETI CAB E FOOT STEP: 60V, 135, 148	31145741
40320	MASSEY FERGUSON	135, 35, 35X	31145631, 731280M1

**RACCORDI PER POMPE ACQUA ADATTABILI**

RACCORD POMPE A EAU ADAPTABLE  
 WATER PUMPS CONNECTIONS ADAPTABLE  
 ANSCHLUSS WASSERPUMPE PASSEND ZU  
 RACOR PARA BOMBA DE AGUA ADAPTABLE

Art./Ref.	Brand	Applicazione/Application	Rif. Orig./Orig. Ref.	Note/Note	Immagine/Image
16692	BRAUD	SERIE SB	98464616	Tubo in plastica per pompa acqua 42999- Plastic pipe for water pump 42999	
17700		1620,1620S	4859907		

Art./Ref.	Brand	Applicazione/Application	Rif. Orig./Orig. Ref.	Note/Note	Immagine/Image
19074	BRAUD	1214	4762764	-	
10485	CASE IH	JX1060C, JX1075C, JX1060V, JX1070V, JX1070C, JX1095, JX1070N, JX1075N, JX1095N, JX55, JX60, JX70, JX75, JX90, JX95, JX55T, JX75T	153625832, 4599810, 4661543, 82982280	Tubazione sopra termostato Upper thermostat pipeline	
14561		JX100U, JX1060C, JX70U, JX80U, JX90U, JX1075C, JX55, JX60, JX70, JX75, JX80, JX90, JX85	4697838	Tubo rigido da pompa a maniccotto intermedio./ Rigid pipe from pump to intermediate hose	
08635	FIAT	1000, 1000S, 1180, 1280, 1380, 250, 300, 420, 450, 460, 466, 480, 480S, 500S, 540S, 605C-S, 500, 540, 550, 566, 570, 580, 600, 640, 666, 680, 760, 766, 780, 880-5, 880S, 980	4673807	Raccordo per - Fitting for Code 05687	
10485		100.55C, 100.90, 100.90DT, 1000S, 880S, 980, 1180, 1280, 115.90, 115.90DT, 130.90, 130.90DT, 1380, 140.90, 140.90DT, 45.66, 45.66DT, 450, 480, 480S, 50.66, 50.66DT, 500S, 540S, 55.46, 55.46DT, 55.56, 55.56DT, 55.65M, 55.66DT, 55.66DT-F-LP, 55.66S, 55.75M, 55.85M, 55.88DT, 55.90, 55.90DT, 580, 60.46, 60.46DT, 60.65M, 60.66S, 60.75M, 60.86, 60.90, 60.90DT, 60.93, 60.93DT, 60.94, 60.94DT, 605C-S, 62.85M, 62.86F-DT, 640, 65.46DT, 65.56, 65.56DT, 65.66-S-DT, 65.88, 65.88DT, 65.90, 65.90DT, 65.93, 65.94, 666, 680, 70.56, 70.56DT, 70.66, 70.66DT, 70.66S, 70.75M, 70.90, 70.90DT, 72-85M, 72.86F-DT, 72.93, 72.94, 780, 780DT, 80.66, 80.75, 80.88, 80.90, 85.90, 88.93, 88.94, 90.90, 95.55, F100, F110, F115, F120, F130, F140	4599810, 4661543	Tubazione sopra termostato Upper thermostat pipeline	
12969		100.90, 100.90DT, 110.90, 110.90DT, 115.90, 115.90DT, 130.90, 130.90DT, 140.90, 140.90DT, 45.66, 45.66DT, 50.66, 50.66DT, 55.46, 55.46DT, 55.56, 55.56DT, 55.65, 55.66, 55.66DT, 55.66S, 55.75, 55.88, 55.88DT, 55.90, 55.90DT, 60.46, 60.46DT, 60.65M, 60.66, 60.66DT, 60.66S, 60.75, 60.76F, 60.86, 60.86DT, 60.86S, 60.88, 60.88DT, 60.90, 60.90DT, 65.46, 65.46DT, 65.56, 65.56DT, 65.66, 65.66DT, 65.88, 65.88DT, 65.90, 65.90DT, 70.56, 70.56DT, 70.65, 70.65M, 70.66, 70.66DT, 70.66S, 70.75, 70.75M, 70.76, 70.76DT, 70.86S, 70.90, 70.90DT, 80.65, 80.66, 80.66DT, 80.66S, 80.75, 80.76F, 80.88, 80.88DT, 80.90, 80.90DT, 85.55, 85.90, 85.90DT, 90.90, 90.90DT, 95.55	4770247	Raccordo per - Fitting for code 05686	
14349		1000S, 480S, 500S, 540S, 605C-S, 500, 600, 900, 1000, 480, 55.66F, 55.76F, 55.86F, 640, 580, 680, 780	4606663, 4614162, 4614165, 4956119	-	
14561		1000S, 880S, 980, 1180, 1280, 1380, 250, 300, 350, 420, 480, 500S, 540S, 605C-S, 640, 50.66, 56.66, 60.66, 65.66, 70.66, 50.86, 55.86, 60.86, 62.86, 70.86, 55.46, 60.46, 65.46, 55.56, 60.56, 65.56, 70.56, 55.65, 55.76, 60.76, 70.76, 80.76, 580, 70.88, 80.88, 60.93, 65.93, 72.93, 72.86, 82.86, 55.88, 60.88, 65.88, 80.66, 60.90, 80.90, 82.93, 88.93, 60.94, 65.94, 72.94, 82.94, 88.94, L60, L65, L75, L85, L95	4614160, 4697838	Tubo rigido da pompa a maniccotto intermedio./ Rigid pipe from pump to intermediate hose	
16692	45.66, 56.66S, 60.66S, 70.66S, 50.86, 55.86, 60.86, 62.86, 70.86, 55.85, 60.85, 62.86, 72.85, 82.85, 55.88, 60.88, 65.88, 70.88, 80.88, 72.86, 82.86, 80.66S, 60.90, 80.90, 88.85, 100.55, F100, F115, F120, F130, F140	98464616	Tubo in plastica per pompa acqua 42999/ Plastic pipe for water pump 42999		

Art./Ref.	Brand	Applicazione/Application	Rif. Orig./Orig. Ref.	Note/Note	Immagine/Image
17700	FIAT	45.66, 55.66S, 60.66S, 70.66S, 45.76,50.86,70.76,80.76,60.86, 50.66,65.66,80.66., 55.56,60.56,S,65.56,70.56, 55.75,60.75,70.75,80.75, 55.85,60.85,100.90,110-90, 60.88,65.88,70.88,80.88, 62.86,82.86,70.86,72.86, 80.66S, 60.90, 80.90, F100, F115, F120, F130, F140	4859907	-	
19074		115-90,130-90,140-90, F100, F115, F120, F130, F140	4762764	-	
10485	FORD	3435, 3830, 3935, 4010S, 4030, 4135, 4430, 4635, 4835, 5635, 6635, 7635, 5010S	4661543	Tubazione sopra termostato Upper thermostat pipeline	
14349		3830	4614162	-	
14561		3010S, 3435, 3830, 3935, 4010S, 4030, 4135, 4230, 4450, 4635, 4835, 5635, 6635, 7635, 8430	4697838	Tubo rigido da pompa a maniccotto intermedio./ Rigid pipe from pump to intermediate hose	
16692		3435 (<C3540), 3935 (<C3540), 4135 (<C3540), 4635, 4835, 5635, 6635, 7635	98464616	Tubo in plastica per pompa acqua 42999/ Plastic pipe for water pump 42999	
17700		3435(<D3350) ,3935(<D3350), 3830,4030,4230,4430, 4135(<D3350)	4859907	-	
42040		2000, 2310, 2600, 2610, 2810, 2910, 3000, 3055, 3230, 3430, 3930, 4130, 4630, 3600, 3610, 3910, 4000, 4100, 4110, 4600, 4610, 5000, 5600, 5700, 6700, 5110, 5610, 5900, 6410, 6610, 555B, 655, 655A, 6600, 6710, 6810, 7410, 7610, 7710, 7000, 7600, 7700, 8000, 8200, 8600, TW10,TW20,TW30	C7NN 8594A	Tubazione sopra termostato Upper thermostat pipeline	
08635		3300AL	4673807	Raccordo per - Fitting for Code 05687	
10485	3300,3400,3750,L517,L518,L520, 3500,3550,3560,3650,3750	4661543	Tubazione sopra termostato Upper thermostat pipeline		

Art./Ref.	Brand	Applicazione/Application	Rif. Orig./Orig. Ref.	Note/Note	Immagine/Image
12969	LAVERDA	3300,3400,3500,3550,3650,3750	4770247	Raccordo per - Fitting for code 05686	
16692		3400,3500	98464616	Tubo in plastica per pompa acqua 42999/ Plastic pipe for water pump 42999	
17700		3400,3550,L517	4859907	-	
19074		3300,3400,3500,3550,3650,3750	4762764	-	
10485	NEW HOLLAND	LB75, SERIE, SERIE TD, DD, TDF, TT, SERIE TNA, TND, TNDA, TNFA, TNNA, SERIE TND, SERIE TNS, SERIE TNF, SERIE TNS, TNSA, TNV, TNVA, TELESCOPICO/TELEHANDLER LM	4661543	Tubazione sopra termostato Upper thermostat pipeline	
14561		SERIE TND, SERIE TNS, SERIE TNF, TL70,, TL70, TL80, TL90, TL100	4697838	Tubo rigido da pompa a manicotto intermedio./ Rigid pipe from pump to intermediate hose	
42040		L781, L783, L785, L865, LX865, LX885	81817129	Tubazione sopra termostato Upper thermostat pipeline	
14561	STEYR	KOMPAKT 360, KOMPAKT 370, KOMPAKT 375	4697838	Tubo rigido da pompa a manicotto intermedio./ Rigid pipe from pump to intermediate hose	
08635	UNIVERSAL	300,340,445,453,530,533	11511144	Raccordo per - Fitting for Code 05687	
10485		300,320,340,350,353,445,453, 500,530,533	11511138	Tubazione sopra termostato Upper thermostat pipeline	



## CINGHIE ADATTABILI

CEINTURES ADAPTABLE

BELTS ADAPTABLE

GÜRTEL PASSEND ZU

CINTURONES ADAPTABLE

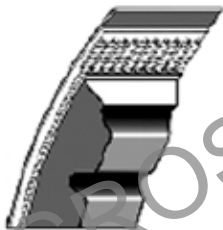

Art./Ref.	Brand	Note/Note	Applicazione/Application	Rif. Orig./Orig. Ref.
27471	CASE	Cinghia alternatore - Con aria condizionata Alternator fan belt - With air conditioning	JX55 - JX60 - JX65 - JX70, JX75 - JX80 - JX85, JX90 - JX95	5140009
40649		Cinghia - Belt	353 - 383 - 423 - 453, 433 - 533 - 633 - 733 - 833, 475 - 533 - 654 - 724 - 824, 644 - 744, 743 - 743XL, 745S - 745XL, 844 - 844S - 844XL, D323	3055715R1, 3116685R1
42951		Cinghia pompa acqua Water pump fan belt	JX100U - JX1060C - JX1070C, JX1075C - JX55 - JX60 - JX65, JX70 - JX70U - JX80U - JX90U	98432119, 98473705
42952		Cinghia pompa acqua Water pump fan belt Con aria condizionata With air conditioning	JX55 - JX60 - JX65 - JX70, JX75 - JX80 - JX85, JX90 - JX95	5140010
12860		Cinghia alternatore Alternator fan belt Con aria condizionata With air conditioning	JX55, JX60, JX65, JX70, JX75, JX80, JX85, JX90, JX95	K605030, K903050
12861		Cinghia - Belt	383, 423, 453 (DYNAMO 11A), 440, 540, 640, 740, 840, 940, 743, 745, 845, 856, 844S, D323	3144678R1
12863		Cinghia - Belt	1294, 1394, 1494, DGD4, JX100, JX1060, JX1075, JX55, JX60, JX65, JX70, JX80, JX90	K68073
27467		Coppia cinghie - Pair of fan belts	JX1060C, JX1070C, JX1075C, JX60, JX70, JX80, JX85, JX90, JX95, JX70U, JX80U, JX90U, JX100U	4796328, 500369112
12860	DAVID BROWN	Cinghia alternatore Alternator fan belt Con aria condizionata With air conditioning	1210, 1212, 850, 880, 890, 990, 950, 990, 995, 996	K903050
12863		Cinghia - Belt	1200, 1210, 1212, 1410, 1412, 1490, 1494, 850, 880, 885, 1190, 1290, 1390, 990, 995, 996, 1194, 1294, 1394	K68073
12860	DEUTZ	Cinghia alternatore Alternator fan belt Con aria condizionata With air conditioning	10006, 8006, AGROPRIMA 4.31, AGROXTRA 3.57, 4.07, 4.17, DX3.10SC, DX3.30SC, DX3.50SC, DX3.10VC, DX3.30VC, DX3.50VC, DX3.60SC, DX3.65SC, DX3.70SC, DX3.60VC, DX3.65VC, DX3.70VC, DX3.75VC, DX3.90VC, DX3.80SC, DX3.90SC, DX4.10, DX4.11, DX4.30, DX6.10, DX6.30, DX85, DX90, DX110, DX120	01175765, 01179566, 02235180, 02235264
12863		Cinghia - Belt	2807, 3006, 3607, DX36	02231579, 02235181
12863	FENDT	Cinghia - Belt	5S, 106LS/LSA/S/SA, F345GTM, F360GTF, F360GTH	X696615001000
27467		Coppia cinghie - Pair of fan belts	102, 102LS, 102LSA, 102S, 102SA, 103, 103LS, 103LSA, 103S, 103SA, 104LS, 104LSA, 104S, 104SA, 105, 105LS, 105LSA, 105S, 105SA, 106LS, 106LSA, 106S, 106SA, 108LS, 108LSA, 108S, 108SA, 200S, 200SA, 200V, 200VA, 201S, 201SA, 203P, 203P/II, 203PA, 204P, 204PA, 204V, 204VA, 205P, 205PA, 240S, 250K, 250KA, 250LE, 250S, 250SA, 250V, 260P, 260PA, 260S, 260SA, 260V, 270PA, 270V, 270VA, 275SA, 275V, 275VA, 280P, 280PA	X696615000000, X696615200000
40660		Cinghia - Belt	300LSA, 303LS, 304LS, 304LSA, 305LS, 305LSA, 306LS, 306LSA, 307, 307C, 307LS, 307LSA, 308, 308C, 308LS, 308LSA, 309, 309C, 309LS, 309LSA, 310, 310LSA, 311, 311LSA, 312, 312LSA	X696616800000
12860	FIAT	Cinghia alternatore Alternator fan belt Con aria condizionata With air conditioning	1000, 1180, 880-5, 250, 300DT, 450, 440V DT, 640, 300, 350, 420, 446, 450, 466, 480, 500, 540, 550, 566, 570, 600, 640, 65, 46, 65, 46DT, 70.56, 65.56, 62.86, 70.86, 72.86, L60, L65, L85, 666, 670, 766, 900, 1000, 70.76F DT, 80.76F DT, 72.94, 82.94, 88.94	4615470, 4615473, 4618920, 4620361, 4620363, 4624736, 4624737, 4688853, 4796327, 920016251, 98473706
12861		Cinghia - Belt	650, 750, 850S	44010698, 8818153

Art./Ref.	Brand	Note/Note	Applicazione/Application	Rif. Orig./Orig. Ref.
12863	FIAT	Cinghia - Belt	100.90,110.90,115.90,130.90, 140.90, 580,880-5,980,1180, 60.93, 60.94DT, 65.93, 72.93, 680, 780, 55.90, 60.90, 65.90, 70.90, 80.90, 85.90DT, 72.94, 82.93, 88.93, 65.94, 82.94, 88.94, 90.90, L60,L65,L75,L85,L95	4696714, 4796650, 4796652
14959		Cinghia - Belt	140.90 - 160.90 - 180.90	98490936
27467		Coppia cinghie - Pair of fan belts	110.90, 115.90, 130.90, 1180, 1180DT, 580, 680, 780, 65-94, 65-94DT, 72-94, 72-94DT, 82-93, 82-93DT, 88-93, 88-93DT, 82-94, 82-94DT, 88-94, 88-94DT, 880-5,980, 90.90, 8805, 980, 1180, 100.90	4688855, 4796325, 4796328, 500369112
27468		Cinghia - Belt	50.86,55.86,60.86,62.86, 55.56L, 45.66S, 50.66S, 45.76V, 55.65,60.65,55.75,60.75,88.85, 55.76V/F DT, 60.76V/F DT	4809679, 4809680, 5186232, 98437415
27471		Cinghia alternatore - Con aria condizionata Alternator fan belt - With air conditioning	65.94 - 65.94DT, 72.94 - 72.94DT, 82.94 - 82.94DT, 88.94 - 88.94DT	5140009
40660		Cinghia - Belt	1580,1880, 160-55,160-90,180-90	4696442, 4796442
42952		Cinghia pompa acqua Water pump fan belt Con aria condizionata With air conditioning	65.94 - 65.94DT, 72.94 - 72.94DT, 82.94 - 82.94DT, 88.94 - 88.94DT	5140010

12860	FORD	Cinghia alternatore Alternator fan belt Con aria condizionata With air conditioning	3010S - 4010S - 5010S, 4030 - 4230 - 4430, 4635 - 4835 - 5635, 6635 - 7635	4796327, 98473706
16899		Cinghia pompa acqua Water pump fan belt Con aria condizionata With air conditioning	2310, 2600, 2610, 2810, 2910, 3600, 3610, 3910, 4100, 4110, 4600, 4610, 5110, 5600, 5610, 5700, 6410, 6600, 6610, 6700, 6710, 6810, 7410, 7600, 7610, 7700, 7710, 7810	80443634, 81843821, 83910824, D6N-N8620A
21840		Cinghia pompa acqua - Water pump fan belt	2000 - 3000 - 4000 - 5000, 2100 - 2300 - 3100 - 3300, 2110 - 2310 - 3310 - 4110, 2150 - 3150, 3190 - 4190 - 5190, 4100 - 4200 - 4400 - 5100, 4130, 5200 - 8200 - 8600, 8000 - 9000, 9200 - 9600	81805736, 81805763, 81827336, C5NE8620B, C9NN10C318B
27468		Cinghia - Belt	3435,3935, 3830,4030	4809680
27471		Cinghia alternatore - Con aria condizionata Alternator fan belt - With air conditioning	4635, 4835, 5635, 6635, 7635	5140009
41988		Cinghia pompa acqua - Water pump fan belt	DEXTA, MAJOR, POWER MAJOR, SUPER DEXTA, SUPER MAJOR	81718146, E1ADKN8620C
41995		Cinghia pompa acqua Water pump fan belt Senza aria condizionata Less air conditioning	2310 - 2610 - 2810 - 2910, 2600 - 8000, 3230 - 3430 - 3930 - 4130, 3600 - 4100 - 4600 - 5600, 3610 - 3910 - 4110 - 4610, 4630 - 4830 - 5030, 5110 - 5610 - 5610S - 6410, 5700 - 6600 - 6700, 6610 - 6610S - 6710 - 6810S, 7010 - 7610S - 7810S - 7910, 8010 - 8210, 8200 - 8600	81822583, 81836785, 81845757, 83976999, 87800127, D3NN10C318C
42013		Cinghia alternatore Alternator fan belt - Con aria condizionata With air conditioning	2310 - 2610 - 2810 - 2910, 2600, 3600 - 4100 - 4600, 3610 - 3910 - 4110 - 4610	83908004, 86518903, D6NN-10C318A
42015		Cinghia alternatore Alternator fan belt - Con aria condizionata With air conditioning	2310 - 2610 - 2810 - 2910, 2600, 3600 - 4100 - 4600 - 5600, 3610 - 3910 - 4110 - 4610, 5110 - 5610 - 6410 - 6610, 5700 - 6600 - 6700, 6710 - 6810 - 7410, 7600 - 7700, 7610 - 7710 - 7810	83949803, E4NN-10C318AA
42017		Cinghia pompa acqua - Water pump fan belt	5110, 5600, 5610, 5700, 6410, 6600, 6610, 6700, 6710, 6810, 7410, 7600, 7610, 7700, 7710, 7810	83963768, 86514611, E7N-N8620AA
42022		Cinghia pompa acqua Water pump fan belt Senza aria condizionata Less air conditioning	5640 (NO AC), 6640 (NO AC)	81865048, 82850751, F0NN-8620FA
42023		Cinghia pompa acqua Water pump fan belt Con aria condizionata With air conditioning	5640(AC), 6640(AC), 7740(AC), 7840(AC), 8240(AC), 8340(AC)	81865047, 82850752, 86518908, 87309963, F2N-N8620AA
42024		Cinghia pompa acqua Water pump fan belt Senza aria condizionata Less air conditioning	7740(NO AC), 7840(NO AC), 8240(NO AC), 8340(NO AC)	81865046, 82850750, 87316556, F0NN-8620GA
42030		Cinghia pompa acqua - Water pump fan belt	TW30, TW35, 7810, 78100, 7910, 8210, 8530, 8630, 8700, 8730, 8830, 9700, 9000,9200,9600,9700, TW5, TW10, TW15, TW20, TW25	89625879, 9625879, E9NN-10C318AB
42031		Cinghia alternatore Alternator fan belt	7910 - 8210, 8530 - 8630 - 8730 - 8830, TW10 - TW15 - TW20 - TW25, TW30 - TW35 - TW5	83912574, D8NN-10C318AA

Art./Ref.	Brand	Note/Note	Applicazione/Application	Rif. Orig./Orig. Ref.
42951	FORD	Cinghia pompa acqua Water pump fan belt	4635, 4835, 5635, 6635, 7635	98432119, 98473705
42952		Cinghia pompa acqua Water pump fan belt Con aria condizionata With air conditioning	4635, 4835, 5635, 6635, 7635	5140010
40646	LANDINI	Cinghia - Belt	16000,16500, ADVANTAGE CABINATO: 65L, ADVANTAGE CABINATO: 55F, ADVANTAGE CABINATO: 55GT, ADVANTAGE CABINATO: 55L, ADVANTAGE CABINATO: 60F, ADVANTAGE CABINATO: 60GT, ADVANTAGE CABINATO: 60L, ADVANTAGE CABINATO: 65F, ADVANTAGE CABINATO: 65GT, ADVANTAGE CABINATO: 75F, ADVANTAGE CABINATO: 75GT, ADVANTAGE CABINATO: 75L, ADVANTAGE CABINATO: 85F, ADVANTAGE CABINATO: 85GT, ADVANTAGE CABINATO: 85L, ADVANTAGE FOOT STEP: 55FP-LP-GT, ADVANTAGE FOOT STEP: 60FP-LP-GT, ADVANTAGE FOOT STEP: 65FP-LP-GT, ADVANTAGE FOOT STEP: 75FP-LP-GT, ADVANTAGE FOOT STEP: 85FP-LP-GT, BLIZZARD: 50, BLIZZARD: 60, BLIZZARD: 65, BLIZZARD: 75, BLIZZARD: 85, CINGOLATI C.F: 4830, CINGOLATI C.F: 5030, CINGOLATI C.F: 5830, CINGOLATI C.F: 6030, CINGOLATI C.F: 6060, CINGOLATI C.F: 6830, CINGOLATI C6: 30, CINGOLATI C7830, CINGOLATI C8860, FRUTTETI 5560 F/L/V, FRUTTETI 560 F/L/V: 4560V, FRUTTETI 6060 F/L/V, FRUTTETI 6560F, FRUTTETI 6560L/V, FRUTTETI 7560F, FRUTTETI 7560L, FRUTTETI 8560F, FRUTTETI 8560L, FRUTTETI 8530F, GLOBUS: 50, REX CABINATI: 60, REX FOOT STEP : 60FP-LP-GE, SERIE 60 NEW: 5860, SERIE 60: 5860, SERIE 60: 6060, SERIE 60: 6860, SERIE 60: 7860, SERIE 60: 7860HC, SERIE 60: 8860, SERIE 60: 8860HC, SERIE 70: 5870, SERIE 70: 6070, SERIE 70: 6870, SERIE 70: 7870, SERIE 70: 8870, SERIE 80: 7880, SERIE 80: 6880, SERIE 80: 8880, SERIE 80: 8880HC, TREKKER C.F: CF55, TREKKER C.F: CF60, TREKKER C.F: CF65, TREKKER C.F: CF70, TREKKER C.F: CF75, TREKKER C.F: CF85, TREKKER C: C75, TREKKER C: C85, VIGNETI CABINA V.Q: 60V, VIGNETI CABINA V.Q: 65V, VIGNETI CABINA V.Q: 75V, VIGNETI CABINA V.Q: 55V, VIGNETI FOOT STEP: 55V, VIGNETI FOOT STEP: 60V, VIGNETI FOOT STEP: 65V, VIGNETI FOOT STEP: 75V, VIGNETI REX CABINATI: 60V, VIGNETI REX CABINATI: 65V	1693746M1 1810548M1, 1851749M1, 1851751M1, 2614B042, 2614B142, 2614B560, 2614B642, 3637595M1
40658		Cinghia - Belt	16000, 16500	2614B667, 2614B677
12860	LAVERDA	Cinghia alternatore Alternator fan belt Con aria condizionata With air conditioning	3300,3400,3500,3550,3650,3750	4796327
42023		Cinghia pompa acqua Water pump fan belt Con aria condizionata With air conditioning	L411,L413,L416,L516	87309953
12861	MASSEY FERGUSON	Cinghia - Belt	1014, 20B,20C,20E,20F,30E,30H,40E, 375E,390E, 50E,5EX,50HS,50HT,50HX,50HXS, 60HS	1687531M1, 2614B154, 2614B654, 3639686M1, 531371M1
12863		Cinghia - Belt	362N,372N,382N (AIRCOND.)	3761507M91
40626		Cinghia - Belt	230 - 240 - 250, 4215 - 4220 - 4225HV, 4235HV - 4245HV - 4255HV, 4315 - 4320	1688988M1, 2641B050
40646		Cinghia - Belt	2640,2645,2680,2685,2725, 3225,3235, 333,334,340,342,350,352,353, 35 (<304621), 354,355,356,360,363,364,366, 367,373,374,376,377,383,384, 387,393,394,396,397,3210,3220, 65 (<241900), 765 (<241900)	1693746M1, 1810548M1, 1851749M1, 1851751M1, 2614B042, 2614B142, 2614B560, 2614B642, 3637595M1
40647		Cinghia - Belt	133,135,140,145,152,165,185, 148, 230, 65(>2419001), 154,164,174,184,194, 188,234,253,254,263,264,273, 194C,244,264, 274,283,284,293,294,333,353, 340,342,350,352,355,360,362, 35 (>304622), 133, 135, 140, 35,765,2205,134C,154C,174C, 354,363,364,373,374,377,383, 356,366,367,376, 372,382,396,3125,3645, 384,387,393,394,397, 765(>2419001), 155, 158, 165	1447784M91, 2612418, 2612419, 2614B043, 2614B143, 2614B145, 2614B645, 3637597M1, 890982M1, 962184M1
40649		Cinghia - Belt	235 - 240 - 245 - 250 - 255, 550	1876670M1
40650		Cinghia - Belt	230 - 275E - 290E, 240(>513538), 250, 375E - 390E, 550(>6206621)	1687531M1, 2612465
40655		Cinghia - Belt	365, 375, 390, 390T, 398, 698T	1693745M1
40658		Cinghia - Belt	1100 - 1300, 2640 - 2675 - 2680 - 2685, 2705 - 2720 - 2725, 3085 - 3095, 3115, 3630 - 3650, 6160 - 6170 - 6180, 8240 - 8240XTRA, 8250 - 8250XTRA, 8260	3040949M1, 3040950M91, 3045111M91, 3386190M91, 3617180M91
40659		Cinghia - Belt	265 - 275 - 285 - 290, 3050, 575 - 590, 675 - 690	2641B559, 3038899M1, 3387562M2, 3581611M1
40660		Cinghia - Belt	3050,3055,3060,3065,3070,3080, 3060, 3065, 3070	3383044M91

Art./Ref.	Brand	Note/Note	Applicazione/Application	Rif. Orig./Orig. Ref.
40661	MASSEY FERGUSON	Cinghia - Belt	1114 - 1134, 2640 - 2645, 3080 - 3090, 3610, 396 - 399, 8260 - 8260XTRA	1447419M91, 2612481, 2614670, 26148170, 3381364M91, 3614706M92
40646	MC CORMICK	Cinghia - Belt	F60,F75,F80,F85,T70,T80,T90, T100,V60,V65	2614B042, 2614B142, 2614B560, 2614B642
12860	NEW HOLLAND	Cinghia alternatore Alternator fan belt Con aria condizionata With air conditioning	L60,L65,L75,L85,L95, L75,L95,TL70,TL80,TL90,TL100, TD55D,TD60D,TD70D,TD75D,TD80D, TD85D,TD90D,TD95D, TL70,TL80,TL90,TL100, TN55,TN65,TN70,TN75, VN240,VN260	98473706
16899		Cinghia pompa acqua - Con aria condizionata.	TF42,TF44,TF46, TX30, TX32, TX36	80443634
27467		Coppia cinghie - Pair of fan belts	TD60D,TD70D,TD80D,TD90D,TD95D, TD80,TD90,TD95, TL70,TL80,TL90,TL100, TN65F, TN70F	4796328, 500369112
27468		Cinghia - Belt	TL70,TL80,TL90,TL100	4809680
27471		Cinghia alternatore - Con aria condizionata	L60 - L65 - L75 - L85 - L95, TD55D - TD60D - TD65D - TD70D, TD75D - TD80D - TD85D, TD90D - TD95D, TL70 - TL80 - TL90 - TL100	5140009
42017		Cinghia pompa acqua Water pump fan belt	L779,L783,L785	86514611
42022		Cinghia pompa acqua Water pump fan belt Senza aria condizionata Less air conditioning	TS100 (NO AC), TS80, TS90 (NO AC)	81865048, 82850751
42023		Cinghia pompa acqua Water pump fan belt Con aria condizionata With air conditioning	TC52,TC54,TC56, TS115(AC), TS90(AC), TS100(AC), TS110(AC)	81865047, 86518908, 87309963
42024		Cinghia pompa acqua Water pump fan belt Senza aria condizionata Less air conditioning	TS110 (NO AC), TS115 (NO AC)	81865046, 82850750, 87316556
42951		Cinghia pompa acqua Water pump fan belt	L60 - L65 - L75 - L85 - L95, TD60 - TD70 - TD60D - TD70D, TK100A, TK65F, TK65V, TK70FA, TK70VA, TK75F, TK75FA, TK75M, TK75MA, TK75V, TK75VA, TK76, TK76M, TK80A, TK80MA, TK85 - TK85M, TK90A, TK90MA, TK95M, TL65 - TL70 - TL80, TL90 - TL100, TN55 - TN65 - TN70 - TN75, TN55D - TN65D - TN70D - TN75D, TN55S - TN65S - TN70S - TN75S, TN60A - TN70A - TN75A, TN60SA - TN70SA - TN75SA, TN65F - TN70F - TN75F, TN65F - TN70F - TN75F - TN75FA, TN75FA - TN85FA - TN95FA, TN80F - TN90F - TN95F, TN80F - TN90F - TN95F - TN95FA	98432119, 98473705
42952	Cinghia pompa acqua Water pump fan belt Con aria condizionata With air conditioning	L60 - L65 - L75 - L85 - L95, TD55D - TD60D - TD65D - TD70D, TD75D - TD80D - TD85D, TD90D - TD95D, TL70 - TL80 - TL90 - TL100	5140010	
12861	PERKINS	Cinghia - Belt	A6.354.1	2614B154, 2614B654
40626		Cinghia - Belt	1004.4T, 903-27, 903-27T, A4.236, A4.41, AD3.152, AT4.236	2641B050
40646		Cinghia - Belt	AD3.152, A6.354.4, AT6.354.4, T6.354.4	2614B042, 2614B142, 2614B560, 2614B642
40650		Cinghia - Belt	A4.236, A4.248, A4.41, A6.372.4, AD3.152, AT6.354.4	2612465
40655		Cinghia - Belt	A4.236, A4.248, AT4.236	1693745M1
40658		Cinghia - Belt	1006.6, A6.354.4, 1006.6T, AT6.354.4, A6.354.1	2614B667, 2614B677
40659		Cinghia - Belt	A4.236, A4.248	2641B559
40661		Cinghia - Belt	1006.6, A6.354.4, AT6.354.4	2612481, 2614670, 2614B170
12863	STEYR	Cinghia - Belt	360,370,375	K68073
27467		Coppia cinghie - Pair of fan belts	KOMPAKT 360/370/375	4796328
42951		Cinghia pompa acqua Water pump fan belt	360 - 370 - 375	98432119, 98473705
12861	VALTRA	Cinghia - Belt	311DS,320D,320DS,420D,420DS, 365,465,505,565,600,665,700, 6000,6100,6300,6400,6600	V684121325

## 1.7.21 Climatizzazione

Air conditioning



**ama**

**Ricambi & accessori per macchine agricole**

SPARE PARTS & ACCESSORIES FOR AGRICULTURAL MACHINE

Tutti gli articoli della presente sezione, prodotti da AMA SPA e/o da terzi per conto di AMA, sono adattabili ("non originali") alle marche indicate ai sensi di quanto previsto dal REG. CE n. 1400/2002. I diritti sui marchi citati appartengono ai legittimi proprietari e il loro uso ha l'esclusiva finalità di consentire all'utilizzatore la comparazione dei diversi prodotti. All items of this section, manufactured by AMA SPA and/or any third party on behalf of AMA, are adaptable ("non-original") to the brands listed under the provisions of the REG. CE n. 1400/2002. The rights on the trademarks belong to their respective owners and their usage is only aimed to allow the user to compare different products.

**COMPRESSORE ARIA CONDIZIONATA ADATTABILE AGCO**

COMPRESSEUR DE CLIMATISATION ADAPTABLE AGCO

AIR CONDITIONING COMPRESSOR ADAPTABLE AGCO

KLIMAKOMPRESSOR PASSEND ZU AGCO

COMPRESOR DE AIRE ACONDICIONADO ADAPTABLE AGCO

Art./Ref.	Note/Note	Brand	Applicazione/Application	Immagine/Image
71632	Compressore aria condizionata adattabile rif. Sanden SD8147/Air conditioning compressor adaptable ref. Sanden SD8147	AGCO	DT180A-DT200A, DT220A-DT240A, LT75A-LT90A, LT85A, LT95A, RT140A-RT155A, RT165A	

**COMPRESSORE ARIA CONDIZIONATA ADATTABILE CASE**

COMPRESSEUR DE CLIMATISATION ADAPTABLE CASE

AIR CONDITIONING COMPRESSOR ADAPTABLE CASE

KLIMAKOMPRESSOR PASSEND ZU CASE

COMPRESOR DE AIRE ACONDICIONADO ADAPTABLE CASE

Art./Ref.	Note/Note	Brand	Applicazione/Application	Rif. Orig./Orig. Ref.	Immagine/Image
71605	Compressore aria condizionata adattabile rif. Sanden SD8230,SD7890,SD8028/Air conditioning compressor adaptable ref. Sanden SD8230,SD7890,SD8028	CASE	MAXXUM 120 - 130 - 140 - 155, MAXXUM 175 - 190	82002069	
71622	Compressore aria condizionata adattabile rif. YORK ER210R/Air conditioning compressor adaptable ref. YORK ER210R		AXIAL FLOW 1440-1460	118250C91	
71625	Compressore aria condizionata adattabile rif. Sanden SD4609/Air conditioning compressor adaptable ref. Sanden SD4609		BI-DIRECTIONAL TVI145, T9000 4WD, T9010, T9020, TJ 275, TJ 280, TJ 325, TJ 330, TVT 135, TVT 155, TVT 170, TVT 190, TVT 195	1999755C3	
71630	Compressore aria condizionata adattabile rif. Sanden SD7862,SD8023/Air conditioning compressor adaptable ref. Sanden SD7862,SD8023		COMBINE 521-525-527	60506146	

**COMPRESSORE ARIA CONDIZIONATA ADATTABILE CHALLENGER**

COMPRESSEUR DE CLIMATISATION ADAPTABLE CHALLENGER  
 AIR CONDITIONING COMPRESSOR ADAPTABLE CHALLENGER  
 KLIMAKOMPRESSOR PASSEND ZU CHALLENGER  
 COMPRESOR DE AIRE ACONDICIONADO ADAPTABLE CHALLENGER



Art./Ref.	Note/Note	Brand	Applicazione/Application	Immagine/Image
71632	Compressore aria condizionata adattabile rif. Sanden SD8147/ Air conditioning compressor adaptable ref. Sanden SD8147	CHALLENGER	MT425B, MT445B, MT455B, MT465B, MT555B-MT565B, MT575B, MT635B-MT645B, MT655B-MT665B	

**COMPRESSORE ARIA CONDIZIONATA ADATTABILE CLAAS**

COMPRESSEUR DE CLIMATISATION ADAPTABLE CLAAS  
 AIR CONDITIONING COMPRESSOR ADAPTABLE CLAAS  
 KLIMAKOMPRESSOR PASSEND ZU CLAAS  
 COMPRESOR DE AIRE ACONDICIONADO ADAPTABLE CLAAS

Art./Ref.	Note/Note	Brand	Applicazione/Application	Rif. Orig./Orig. Ref.	Immagine/Image
71612	Compressore aria condizionata adattabile rif. Denso 10PA15C447170-8930/Air conditioning compressor adaptable ref. Denso 10PA15C447170-8930	CLAAS	CELTICS 456 RC		
71620	Compressore aria condizionata adattabile rif. Sanden SD6651/Air conditioning compressor adaptable ref. Sanden SD6651		MIETITREBBIE DOMINATOR, MIETITREBBIE MEDION, MIETITREBBIE MEGA	625.879.0	
71622	Compressore aria condizionata adattabile rif. YORK ER210R/Air conditioning compressor adaptable ref. YORK ER210R		DOMINATOR, JAGUAR 685-690-695, MEGA	402466, 621.029.0	
71630	Compressore aria condizionata adattabile rif. Sanden SD7862,SD8023/Air conditioning compressor adaptable ref. Sanden SD7862,SD8023		CELTICS 426-436-446		
71631	Compressore aria condizionata adattabile rif. Sanden SD8088,SD7952/Air conditioning compressor adaptable ref. Sanden SD8088, SD7952		RANGER TELES 928-925, RANGER TELES 975-964	315.792.0	



**COMPRESSORE ARIA CONDIZIONATA ADATTABILE DEUTZ**
*COMPRESSEUR DE CLIMATISATION ADAPTABLE DEUTZ*
*AIR CONDITIONING COMPRESSOR ADAPTABLE DEUTZ*
*KLIMAKOMPRESSOR PASSEND ZU DEUTZ*
*COMPRESOR DE AIRE ACONDICIONADO ADAPTABLE DEUTZ*

Art./Ref.	Note/Note	Brand	Applicazione/Application	Rif. Orig./Orig. Ref.	Immagine/Image
<b>71606</b>	Compressore aria condizionata adattabile rif. Sanden SD8091/Air conditioning compressor adaptable ref. Sanden SD8091	<b>DEUTZ</b>	AGROFARM - AGROFARM COM 3, AGROTRON, AGROTRON 4, AGROTRON 6, AGROTRON K - AGROTRON K COM 3, AGROTRON MK3, AGROTRON NEW, AGROTRON PROFILINE, AGROTRON TTV	04437338	
<b>71630</b>	Compressore aria condizionata adattabile rif. Sanden SD7862,SD8023/Air conditioning compressor adaptable ref. Sanden SD7862,SD8023		AGROTRON 230-260	4437339	

**COMPRESSORE ARIA CONDIZIONATA ADATTABILE FENDT**
*COMPRESSEUR DE CLIMATISATION ADAPTABLE FENDT*
*AIR CONDITIONING COMPRESSOR ADAPTABLE FENDT*
*KLIMAKOMPRESSOR PASSEND ZU FENDT*
*COMPRESOR DE AIRE ACONDICIONADO ADAPTABLE FENDT*

Art./Ref.	Note/Note	Brand	Applicazione/Application	Rif. Orig./Orig. Ref.	Immagine/Image
<b>71610</b>	Compressore aria condizionata adattabile rif. Denso 10PA15C447100-5050/Air conditioning compressor adaptable ref. Denso 10PA15C447100-5050	<b>FENDT</b>	FARMER 200-300-400, FAVORIT 500-700-800-900, GT370-380-390-395, XILON 520-522-524	G311550020100	

**COMPRESSORE ARIA CONDIZIONATA ADATTABILE FIAT**
*COMPRESSEUR DE CLIMATISATION ADAPTABLE FIAT*
*AIR CONDITIONING COMPRESSOR ADAPTABLE FIAT*
*KLIMAKOMPRESSOR PASSEND ZU FIAT*
*COMPRESOR DE AIRE ACONDICIONADO ADAPTABLE FIAT*

Art./Ref.	Note/Note	Brand	Applicazione/Application	Rif. Orig./Orig. Ref.	Immagine/Image
<b>71605</b>	Compressore aria condizionata adattabile rif. Sanden SD8230,SD7890,SD8028/Air conditioning compressor adaptable ref. Sanden SD8230,SD7890,SD8028	<b>FIAT</b>	SERIE 60	82002069	
<b>72742</b>	Compressore aria condizionata adattabile rif. Sanden SD7928/Air conditioning compressor adaptable ref. Sanden SD7928		160-90 DT, 180-90 DT, F100, F100 DT, F115, F115 DT, F130, F130 DT, F140, F140 DT	5165548	
<b>84677</b>	Compressore aria condizionata adattabile rif. Sanden SD7929, SD8223/Air conditioning compressor adaptable ref. Sanden SD7929, SD8223		140-90 DT, 50-86S V, 55-86 F, 55-86F DT, 55-86S V, 55-86S V DT, 60-86 F DT, 60-86F, 60-86S V, 60-86S V DT, 65-94, 65-94 DT, 70-86S V, 70-86S V DT, 72-94, 72-94 DT, 82-94, 82-94 DT, 88-94, 88-94 DT	5165549	



**COMPRESSORE ARIA CONDIZIONATA ADATTABILE FORD**

COMPRESSEUR DE CLIMATISATION ADAPTABLE FORD

AIR CONDITIONING COMPRESSOR ADAPTABLE FORD

KLIMAKOMPRESSOR PASSEND ZU FORD

COMPRESOR DE AIRE ACONDICIONADO ADAPTABLE FORD

Art./Ref.	Note/Note	Brand	Applicazione/Application	Rif. Orig./Orig. Ref.	Immagine/Image
71605	Compressore aria condizionata adattabile rif. Sanden SD8230,SD7890,SD8028/Air conditioning compressor adaptable ref. Sanden SD8230,SD7890,SD8028	FORD	8160, 8260, 8360, 8560	82002069	
71623	Compressore aria condizionata adattabile rif. Sanden SD8100/Air conditioning compressor adaptable ref. Sanden SD8100		8160-8260-8360-8560	82016158	
72742	Compressore aria condizionata adattabile rif. Sanden SD7928/Air conditioning compressor adaptable ref. Sanden SD7928		8630 - 8830	5165548	
84677	Compressore aria condizionata adattabile rif. Sanden SD7929, SD8223/Air conditioning compressor adaptable ref. Sanden SD7929, SD8223		4635, 4835, 5635, 6635, 7635, 8430	5165549	

**COMPRESSORE ARIA CONDIZIONATA ADATTABILE JCB**

COMPRESSEUR DE CLIMATISATION ADAPTABLE JCB

AIR CONDITIONING COMPRESSOR ADAPTABLE JCB

KLIMAKOMPRESSOR PASSEND ZU JCB

COMPRESOR DE AIRE ACONDICIONADO ADAPTABLE JCB

Art./Ref.	Note/Note	Brand	Rif. Orig./Orig. Ref.	Immagine/Image
71608	Compressore aria condizionata adattabile rif. Sanden SD8024,SD7863,SD8220/Air conditioning compressor adaptable ref. Sanden SD8024,SD7863,SD8220	JCB	123/04998, 997/04600	

**COMPRESSORE ARIA CONDIZIONATA ADATTABILE JOHN DEERE**

COMPRESSEUR DE CLIMATISATION ADAPTABLE JOHN DEERE

AIR CONDITIONING COMPRESSOR ADAPTABLE JOHN DEERE

KLIMAKOMPRESSOR PASSEND ZU JOHN DEERE

COMPRESOR DE AIRE ACONDICIONADO ADAPTABLE JOHN DEERE

Art./Ref.	Note/Note	Brand	Applicazione/Application	Rif. Orig./Orig. Ref.	Immagine/Image
71611	Compressore aria condizionata adattabile rif. Denso 10PA15C447100-2990/Air conditioning compressor adaptable ref. Denso 10PA15C447100-2990	JOHN DEERE	MIETITREBBIA	AZ44541	
71612	Compressore aria condizionata adattabile rif. Denso 10PA15C447170-8930/Air conditioning compressor adaptable ref. Denso 10PA15C447170-8930		TRATTORE SERIE.6000	AL755836, AL78779	



**COMPRESSORE ARIA CONDIZIONATA ADATTABILE LAMBORGHINI**

COMPRESSEUR DE CLIMATISATION ADAPTABLE LAMBORGHINI

AIR CONDITIONING COMPRESSOR ADAPTABLE LAMBORGHINI

KLIMAKOMPRESSOR PASSEND ZU LAMBORGHINI

COMPRESOR DE AIRE ACONDICIONADO ADAPTABLE LAMBORGHINI

Art./Ref.	Note/Note	Brand	Applicazione/Application	Rif. Orig./Orig. Ref.	Immagine/Image
<b>71602</b>	Compressore aria condizionata adattabile rif. Sanden SD7170/Air conditioning compressor adaptable ref. Sanden SD7170	<b>LAMBORGHINI</b>	880F-PLUS, 990F-PLUS	0.007.7197.4	
<b>71630</b>	Compressore aria condizionata adattabile rif. Sanden SD7862,SD8023/Air conditioning compressor adaptable ref. Sanden SD7862,SD8023		CHAMPION 180		



**COMPRESSORE ARIA CONDIZIONATA ADATTABILE LANDINI**

COMPRESSEUR DE CLIMATISATION ADAPTABLE LANDINI

AIR CONDITIONING COMPRESSOR ADAPTABLE LANDINI

KLIMAKOMPRESSOR PASSEND ZU LANDINI

COMPRESOR DE AIRE ACONDICIONADO ADAPTABLE LANDINI

Art./Ref.	Note/Note	Brand	Applicazione/Application	Rif. Orig./Orig. Ref.	Immagine/Image
<b>71601</b>	Compressore aria condizionata adattabile rif. Sanden SD7851/Air conditioning compressor adaptable ref. Sanden SD7851	<b>LANDINI</b>	ADVANTAGE 4 CYL, ADVANTAGE VIGNETI, BLIZZARD	3550921M91	
<b>71613</b>	Compressore aria condizionata adattabile rif. Delpy-Harrison 085015120/1A/Air conditioning compressor adaptable ref. Delpy-Harrison 085015120/1A		LANDPOWER, LEGEND 105, MYTHOS 115, SERIE 80, VISION 85-95-105	3552611M91	
<b>71614</b>	Compressore aria condizionata adattabile rif. Sanden SD9149/Air conditioning compressor adaptable ref. Sanden SD9149		10000, 12500, 13000, 14500, 16000, 16500, 16550, 17500, 19000, 19500	3386861M1	



**COMPRESSORE ARIA CONDIZIONATA ADATTABILE LAVERDA**

COMPRESSEUR DE CLIMATISATION ADAPTABLE LAVERDA

AIR CONDITIONING COMPRESSOR ADAPTABLE LAVERDA

KLIMAKOMPRESSOR PASSEND ZU LAVERDA

COMPRESOR DE AIRE ACONDICIONADO ADAPTABLE LAVERDA

Art./Ref.	Note/Note	Brand	Applicazione/Application	Rif. Orig./Orig. Ref.	Immagine/Image
<b>71614</b>	Compressore aria condizionata adattabile rif. Sanden SD6631/Air conditioning compressor adaptable ref. Sanden SD6631	<b>LAVERDA</b>	1950 lx mietitrebbiatrice, 1950 mcs mietitrebbiatrice, 2050 mcs mietitrebbiatrice, 2560 mcs mietitrebbiatrice, 2760 ls mietitrebbiatrice, 2760 mcs mietitrebbiatrice, l 518-l 520 mietitrebbiatrice, l517 mietitrebbiatrice, l624 mietitrebbiatrice, l625 mietitrebbiatrice, l626 mietitrebbiatrice, l627 mietitrebbiatrice	322333200	
<b>72742</b>	Compressore aria condizionata adattabile rif. Sanden SD7928/Air conditioning compressor adaptable ref. Sanden SD7928		L521, L523 INTEGR, L523 MCS, L524, L525 INTEGR, L525 MCS	5165548	

**COMPRESSORE ARIA CONDIZIONATA ADATTABILE MASSEY FERGUSON**

COMPRESSEUR DE CLIMATISATION ADAPTABLE MASSEY FERGUSON

AIR CONDITIONING COMPRESSOR ADAPTABLE MASSEY FERGUSON

KLIMAKOMPRESSOR PASSEND ZU MASSEY FERGUSON

COMPRESOR DE AIRE ACONDICIONADO ADAPTABLE MASSEY FERGUSON

Art./Ref.	Note/Note	Brand	Applicazione/Application	Rif. Orig./Orig. Ref.	Immagine/Image
71601	Compressore aria condizionata adattabile rif. Sanden SD7851/ Air conditioning compressor adaptable ref. Sanden SD7851		373, 374, 383, 384, 393, 394	3550921M91	
71602	Compressore aria condizionata adattabile rif. Sanden SD7170/ Air conditioning compressor adaptable ref. Sanden SD7170		VSF 3000		
71614	Compressore aria condizionata adattabile rif. Sanden SD9149/ Air conditioning compressor adaptable ref. Sanden SD9149		1014, 1024, 1035, 1134, SERIE 2000, SERIE 3000, SERIE 3600	3386861M1	
71622	Compressore aria condizionata adattabile rif. YORK ER210R/ Air conditioning compressor adaptable ref. YORK ER210R	<b>MASSEY FERGUSON</b>	MIETITREBBIE SERIE 27-29-31, MIETITREBBIE SERIE 6-8	D45054800	
71631	Compressore aria condizionata adattabile rif. Sanden SD8088,SD7952/ Air conditioning compressor adaptable ref. Sanden SD8088, SD7952		3060-3065-3075-3085-3095, 3120-3125, 3635-3645-3655-3670-3690, 4225-4235-4240, 4245-4255-4265, 4260-4270, 4325-4335, 4345-4355, 4360-4370, 5335-5340-5355-5360-5365, 5425-5435-5445-5455, 5470, 5470SA-5475SA, 6120-6130-6140-6150, 6160-6170-6180-6190, 6235-6245-6255, 6260-6265-6270-6280-6290, 660-680, 8110-8120-8130-8140, 8150-8160-8170-8180, 8210-8220-8240-8250, 8260-8270-8280	3712528M2, 3782613M2	
71632	Compressore aria condizionata adattabile rif. Sanden SD8147/Air conditioning compressor adaptable ref. Sanden SD8147		DT180A-DT200A, DT220A-DT240A, LT75A-LT90A, LT85A, LT95A, MF5425, MF5435, MF5445, MF5455, MF5460, MF5460/5460SA, MF5470, MF5480, MF6445, MF6445/6455, MF6455, MF6460, MF6460/6470, MF6465/6475/6480, MF6470, MF6485/6490, MF6495, MF6497, MF6497/6499, MF6499, MF7465/7475/7480, MF7485/7490, MF7495, MF8450/8460, MF8470/8480, RT140A/RT155A, RT165A	3789035M1, 4789035M1	

**COMPRESSORE ARIA CONDIZIONATA ADATTABILE NEW HOLLAND**

COMPRESSEUR DE CLIMATISATION ADAPTABLE NEW HOLLAND  
 AIR CONDITIONING COMPRESSOR ADAPTABLE NEW HOLLAND  
 KLIMAKOMPRESSOR PASSEND ZU NEW HOLLAND  
 COMPRESOR DE AIRE ACONDICIONADO ADAPTABLE NEW HOLLAND

Art./Ref.	Note/Note	Brand	Applicazione/Application	Rif. Orig./Orig. Ref.	Immagine/Image
71605	Compressore aria condizionata adattabile rif. Sanden SD8230,SD7890,SD8028/Air conditioning compressor adaptable ref. Sanden SD8230,SD7890,SD8028	<b>NEW HOLLAND</b>	M100, M115, M135, M160	82002069	
71623	Compressore aria condizionata adattabile rif. Sanden SD8100/Air conditioning compressor adaptable ref. Sanden SD8100	<b>NEW HOLLAND</b>	M100-M115-M135-M160, TM115-120-125-130-135-140, TM150-155-165-175-180-190, TV140	82016158	
71630	Compressore aria condizionata adattabile rif. Sanden SD7862,SD8023/Air conditioning compressor adaptable ref. Sanden SD7862,SD8023	<b>NEW HOLLAND</b>	FORAGER, FX300-375-450, TC56 COMBINE, TN62-64-65-68 COMBINE	84018078, 89831429	
71642	Compressore aria condizionata adattabile rif. Sanden SD6332/Air conditioning compressor adaptable ref. Sanden SD6332	<b>NEW HOLLAND</b>	TN55D, TN55S, TN55V, TN60DA, TN60SA, TN60VA, TN65D, TN65F, TN65N, TN65S, TN65V, TN70D, TN70DA, TN70F, TN70NA, TN70S, TN70SA, TN70VA, TN75D, TN75DA, TN75F, TN75FA, TN75N, TN75NA, TN75S, TN75SA, TN75V, TN75VA, TN80F, TN85FA, TN90F, TN95F, TN95FA, TN95NA, TN95VA	5176185	
72742	Compressore aria condizionata adattabile rif. Sanden SD7928/Air conditioning compressor adaptable ref. Sanden SD7928	<b>NEW HOLLAND</b>	VENDEMMIATRICI SB-VL-VM-VN-VX	5165548	
84677	Compressore aria condizionata adattabile rif. Sanden SD7929, SD8223/Air conditioning compressor adaptable ref. Sanden SD7929, SD8223	<b>NEW HOLLAND</b>	L60, L65, L75, L85, L95, TD55D, TD60D, TD65D, TD70D, TD75D, TD80D, TD85D, TD90D, TD95D, TL100, TL70, TL80, TL90	5165549	

**COMPRESSORE ARIA CONDIZIONATA ADATTABILE SAME LAMBORGHINI HURLIMANN**

COMPRESSEUR DE CLIMATISATION ADAPTABLE SAME LAMBORGHINI HURLIMANN  
 AIR CONDITIONING COMPRESSOR ADAPTABLE SAME LAMBORGHINI HURLIMANN  
 KLIMAKOMPRESSOR PASSEND ZU SAME LAMBORGHINI HURLIMANN  
 COMPRESOR DE AIRE ACONDICIONADO ADAPTABLE SAME LAMBORGHINI HURLIMANN

Art./Ref.	Note/Note	Brand	Applicazione/Application	Rif. Orig./Orig. Ref.	Immagine/Image
71600	Compressore aria condizionata adattabile rif. Sanden SD7849/Air conditioning compressor adaptable ref. Sanden SD7849	<b>SAME LAMBORGHINI HURLIMANN - SAME</b>	DORADO 55, DORADO 56 - 56 EXPORT USA, DORADO 56 CLASSIC, DORADO 60, DORADO 65, DORADO 66, DORADO 66 - 66 EXPORT USA, DORADO 66 CLASSIC, DORADO 70, DORADO 75, DORADO 76 - 76 EXPORT USA, DORADO 76 CLASSIC, DORADO 85, DORADO 86 - 86 EXPORT USA, DORADO 86 CLASSIC, EXPLORER 75 NEW AND CLASSIC, EXPLORER 85, EXPLORER 95 NEW AND CLASSIC, LASER 100, LASER 110, LASER 125, LASER 130, LASER 140, LASER 150, LASER 160, ROLLER 55 W, ROLLER 70 W, ROW CROP 100.6, SILVER 100.4, SILVER 100.6, SILVER 105, SILVER 110, SILVER 80, SILVER 85, SILVER 90, SILVER 95, TITAN 160, TITAN 190	0.009.7660.4	

# 1.7.22 Cingolature

Track chain



**ama**

**Ricambi & accessori per macchine agricole**

**SPARE PARTS & ACCESSORIES FOR AGRICULTURAL MACHINE**

Tutti gli articoli della presente sezione, prodotti da AMA SPA e/o da terzi per conto di AMA, sono adattabili ("non originali") alle marche indicate ai sensi di quanto previsto dal REG. CE n. 1400/2002. I diritti sui marchi citati appartengono ai legittimi proprietari e il loro uso ha l'esclusiva finalità di consentire all'utilizzatore la comparazione dei diversi prodotti. All items of this section, manufactured by AMA SPA and/or any third party on behalf of AMA, are adaptable ("non-original") to the brands listed under the provisions of the REG. CE n. 1400/2002. The rights on the trademarks belong to their respective owners and their usage is only aimed to allow the user to compare different products.

**CINGOLATURE CON PASSO CATENE DA 125 MM ADATTABILI FIAT**
*PISTES AVEC CHAINES PITCH 125 MM ADAPTABLE FIAT*
*TRACKS WITH PITCH CHAINS 125 MM ADAPTABLE FIAT*
*TRACKS MIT PITCH CHAINS 125 MM PASSEND ZU FIAT*
*LAS PISTAS CON CADENA DE PASO 125 MM ADAPTABLE FIAT*



Art./Ref.	Passo/Pitch	Maglie/Links	Note/Notes	Brand	Applicazione/Application	Rif. Orig./Orig. Ref.	Immagine/Image
<b>18209</b>	125	33	Catena passo 125 mm da 33 maglie - Chain pitch 125 mm 33 links - Ref. Berco FT1335/33	<b>FIAT</b>	25C-25CI-25CS-25CSI, 311-311C-311CI, 312-312C, 322-322C, 331C-331CI, 332-332C, 351-351C, 352-352C, 355-355MONTAGNA-355F, AD3	557115	
<b>14167</b>	125	34	Catena passo 125 mm da 34 maglie - Chain pitch 125 mm 34 links - Ref. Berco FT1335/34		355C-355 C MONTAGNA, 455C-455C SUPER-455CF, 455CM-455CMS	4960993	
<b>15943</b>	125	35	Catena passo 125 mm da 35 maglie - Chain pitch 125 mm 35 links - Ref. Berco FT1335/35		465C-465CF FRUTTETO, 465CM MONTAGNA-465CV VIGNETO, 55.65, 55.65FRUTTETO, 55.65MONTAGNA, 55.65VIGNETO, 55.75, 55.75FRUTTETO, 55.75MONTAGNA, 55.75VIGNETO, 55.85, 55.85FRUTTETO, 55.85MONTAGNA, 55.85VIGNETO, 60.65VIGNETO, 60.75VIGNETO, 60.85FRUTTETO, 60.85VIGNETO	5114442, 5193415	
<b>14165</b>	125	-	Rullo Cpt.1B con boccola / Tracking Cpt.1B with bushing - Ref. Berco FT3541		355 MONTAGNA, 355C-355C MONTAGNA, 455 SECOND TYPE, 455C SECOND TYPE, 455C SUPER, 455CF-455CM-455CMS-, 465-465C, 465CF FRUTTETO, 465CM MONTAGNA, 465CV VIGNETO, 55.65 FRUTTETO, 55.65 MONTAGNA, 55.65 VIGNETO, 55.75 FRUTTETO, 55.75 MONTAGNA, 55.75 VIGNETO, 55.85 FRUTTETO, 55.85 MONTAGNA, 55.85 VIGNETO, 60.65 VIGNETO, 60.75 VIGNETO, 60.85 FRUTTETO, 60.85 VIGNETO	4968573, 5173247, 5193323	
<b>83165</b>	125	-	Rullo Cpt.2B con boccola / Tracking Cpt.2B with bushing - Ref. Berco FT3580		-	-	
<b>14170</b>	125	-	Suola a 1 costa da 250 mm - Shoe 1 grouser 250 mm - Ref. Berco FT1238/250		311C-311CI, 312C-351C, 352C, 355 MONTAGNA-355C MONTAGNA, 355F, 455C SECOND TYPE, 455C SUPER, 455CF, 465CV VIGNETO, 55.65 VIGNETO, 55.75 VIGNETO, 55.85 VIGNETO, 60.65 VIGNETO, 60.75 VIGNETO, 60.85 VIGNETO, AD3	5193416, 558435	
<b>84394</b>	125	-	Suola a 1 costa da 280 mm - Shoe 1 grouser 280 mm - Ref. Berco FT1238/280		465CF FRUTTETO, 55.65 FRUTTETO, 55.75 FRUTTETO	5127837	
<b>16488</b>	125	-	Suola a 1 costa da 300 mm - Shoe 1 grouser 300 mm - Ref. Berco FT1238/300		455CM MONTAGNA, 465C, 465CM MONTAGNA, 55.65 MONTAGNA, 55.75 MONTAGNA, 55.85 MONTAGNA	4960799, 5193417, 560860	
<b>84395</b>	125	-	Suola a 1 costa da 310 mm - Shoe 1 grouser 310 mm - Ref. Berco FT1238/310		455 SECOND TYPE	-	
<b>16487</b>	125	-	Ruota Motrice - Sprocket - Ref. Berco FT667		311C, 312-312C, 351-351C, 352C, 355-355 MONTAGNA, 355C MONTAGNA, 455C SECOND TYPE, 455C SUPER, 455CM, AD3	4958366, 568070	
<b>16492</b>	125	-	Ruota Motrice - Sprocket - Ref. Berco FT2289		55.65F, 55.75F, 55.85F, 55.85M, 55.85V, 60.85F, 60.85V	5129972	
<b>18207</b>	125	-	Ruota Motrice - Sprocket - Ref. Berco FT2290		55.65M, 55.65V, 55.75M, 55.75V, 55.85F, 55.85M, 55.85V, 60.65, 60.65M, 60.65V, 60.75, 60.75M, 60.75V, 60.85F, 60.85V	5112858, 5129967	

**CINGOLATURE CON PASSO CATENE DA 125 MM ADATTABILI NEW HOLLAND**



PISTES AVEC CHAINES PITCH 125 MM ADAPTABLE NEW HOLLAND  
 TRACKS WITH PITCH CHAINS 125 MM ADAPTABLE NEW HOLLAND  
 TRACKS MIT PITCH CHAINS 125 MM PASSEND ZU NEW HOLLAND  
 LAS PISTAS CON CADENA DE PASO 125 MM ADAPTABLE NEW HOLLAND

Art./Ref.	Passo/Pitch	Maglie/Links	Note/Notes	Brand	Applicazione/Application	Rif. Orig./Orig. Ref.	Immagine/Image
18209	125	33	Catena passo 125 mm da 33 maglie - Chain pitch 125 mm 33 links - Ref. Berco FT1335/33	NEW HOLLAND	-	-	
14167	125	34	Catena passo 125 mm da 34 maglie - Chain pitch 125 mm 34 links - Ref. Berco FT1335/34		-	-	
15943	125	35	Catena passo 125 mm da 35 maglie - Chain pitch 125 mm 35 links - Ref. Berco FT1335/35		TK4020F-TK4020V, TK65F-TK65V, TK70VA, TK75V-TK75VA	5193415	
14165	125	-	Rullo Cpt.1B con boccola / Tracking Cpt.1B with bushing - Ref. Berco FT3541		TK4020F-TK4020V, TK65F-TK65V, TK70VA, TK75V-TK75VA	5193323	
83165	125	-	Rullo Cpt.2B con boccola / Tracking Cpt.2B with bushing - Ref. Berco FT3580		TK4020F, TK4020V, TK4030V, TK60-TK70-TK75, TK65F, TK65V, TK70FA, TK70VA, TK75V, TK75VA	5177416, 5193324	
14170	125	-	Suola a 1 costa da 250 mm - Shoe 1 grouser 250 mm - Ref. Berco FT1238/250		TK65V, TK75V	5193416	
84394	125	-	Suola a 1 costa da 280 mm - Shoe 1 grouser 280 mm - Ref. Berco FT1238/280		TK70VA	5127837	
16488	125	-	Suola a 1 costa da 300 mm - Shoe 1 grouser 300 mm - Ref. Berco FT1238/300		TK65F	5193417	
84395	125	-	Suola a 1 costa da 310 mm - Shoe 1 grouser 310 mm - Ref. Berco FT1238/310		TK4020-TK4020F	-	
16487	125	-	Ruota Motrice - Sprocket - Ref. Berco FT667		-	-	
16492	125	-	Ruota Motrice - Sprocket - Ref. Berco FT2289		TK100A, TK4020F, TK4020V, TK55-65F, TK55-75F, TK55-85F, TK55-85M, TK55-85V, TK60-85F, TK60-85V, TK65F, TK65V, TK70FA, TK70VA, TK75F, TK75FA, TK75M, TK75MA, TK75V, TK75VA, TK76, TK76M, TK80A, TK80MA, TK85, TK85M, TK90A, TK90MA, TK95M	5129972	
18207	125	-	Ruota Motrice - Sprocket - Ref. Berco FT2290		TK100A, TK4020F, TK4020V, TK4030V, TK65F, TK65V, TK70FA, TK70VA, TK75F, TK75FA, TK75M, TK75MA, TK75V, TK75VA, TK76, TK76M, TK80A, TK80MA, TK85, TK85M, TK90A, TK90MA, TK95M	5112858, 5129967	

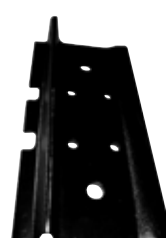
**CINGOLATURE CON PASSO CATENE DA 125 MM ADATTABILI LANDINI**
*PISTES AVEC CHAINES PITCH 125 MM ADAPTABLE LANDINI*
*TRACKS WITH PITCH CHAINS 125 MM ADAPTABLE LANDINI*
*TRACKS MIT PITCH CHAINS 125 MM PASSEND ZU LANDINI*
*LAS PISTAS CON CADENA DE PASO 125 MM ADAPTABLE LANDINI*

Art./Ref.	Passo/Pitch	Maglie/Links	Note/Notes	Brand	Applicazione/Application	Rif. Orig./Orig. Ref.	Immagine/Image
<b>18209</b>	125	33	Catena passo 125 mm da 33 maglie - Chain pitch 125 mm 33 links - Ref. Berco FT1335/33	<b>LANDINI</b>	C35-CL35-CS35, C4000-CL4000-CS4000	976142M93	
<b>15943</b>	125	35	Catena passo 125 mm da 35 maglie - Chain pitch 125 mm 35 links - Ref. Berco FT1335/35		4500-4500M-4500S, 4830-4830C-4830CL MONTAGNA, 4830CS, TREKKER 55F LARGO E STRETTO	1825109M1, 3539041M93, 4205513M91	
<b>14165</b>	125	-	Rullo Cpt. 1B con boccola / Tracking Cpt. 1B with bushing - Ref. Berco FT3541		4500M-4500S, 4830C-4830CL MONTAGNA-4830CS, TREKKER 55F LARGO, TREKKER 55F STRETTO, TREKKER 60F, TREKKER 60F LARGO, TREKKER 60F STRETTO	-	
<b>14170</b>	125	-	Suola a 1 costa da 250 mm - Shoe 1 grouser 250 mm - Ref. Berco FT1238/250		4500S, 4830CS, C3200 3 ROLLERS, C3200 4 ROLLERS, C4000, CL35, TREKKER 55F STRETTO, TREKKER 60F STRETTO	1816941M1	
<b>84394</b>	125	-	Suola a 1 costa da 280 mm - Shoe 1 grouser 280 mm - Ref. Berco FT1238/280		4500, 4830-4830C, C35, CL3200 3 ROLLERS, CL3200 4 ROLLERS, CL4000, TREKKER 60, TREKKER 60F	978780M1	
<b>84395</b>	125	-	Suola a 1 costa da 310 mm - Shoe 1 grouser 310 mm - Ref. Berco FT1238/310		4500M, 4830CL MONTAGNA, TREKKER 55F LARGO, TREKKER 60F LARGO	1816331M1	

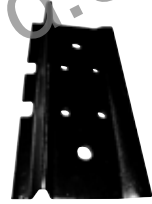

**CINGOLATURE CON PASSO CATENE DA 125 MM ADATTABILI MASSEY FERGUSON**
*PISTES AVEC CHAINES PITCH 125 MM ADAPTABLE MASSEY FERGUSON*
*TRACKS WITH PITCH CHAINS 125 MM ADAPTABLE MASSEY FERGUSON*
*TRACKS MIT PITCH CHAINS 125 MM PASSEND ZU MASSEY FERGUSON*
*LAS PISTAS CON CADENA DE PASO 125 MM ADAPTABLE MASSEY FERGUSON*

Art./Ref.	Passo/Pitch	Maglie/Links	Note/Notes	Brand	Applicazione/Application	Rif. Orig./Orig. Ref.	Immagine/Image
<b>15943</b>	125	35	Catena passo 125 mm da 35 maglie - Chain pitch 125 mm 35 links - Ref. Berco FT1335/35	<b>MASSEY FERGUSON</b>	MF134-MF134C-MF134CL-MF134CS, MF234-MF234C-MF234CF-MF234CL, MF234CS	3539041M93	
<b>14165</b>	125	-	Rullo Cpt. 1B con boccola / Tracking Cpt. 1B with bushing - Ref. Berco FT3541		MF134C-MF134CL-MF134CS, MF234C-MF234CF-MF234CL-MF234CS	-	
<b>14170</b>	125	-	Suola a 1 costa da 250 mm - Shoe 1 grouser 250 mm - Ref. Berco FT1238/250		MF114C-MF114CS, MF124-MF124CS, MF134-MF134CS, MF234-MF234CS	1816941M1	
<b>84394</b>	125	-	Suola a 1 costa da 280 mm - Shoe 1 grouser 280 mm - Ref. Berco FT1238/280		MF114CL, MF124-MF124C, MF134-MF134C, MF234-MF234CF	978780M1	
<b>84395</b>	125	-	Suola a 1 costa da 310 mm - Shoe 1 grouser 310 mm - Ref. Berco FT1238/310		MF124CL, MF134-MF134CL, MF234-MF234CL	1816331M1	





**CINGOLATURE CON PASSO CATENE DA 125 MM ADATTABILI LAMBORGHINI**

PISTES AVEC CHAINES PITCH 125 MM ADAPTABLE LAMBORGHINI  
 TRACKS WITH PITCH CHAINS 125 MM ADAPTABLE LAMBORGHINI  
 TRACKS MIT PITCH CHAINS 125 MM PASSEND ZU LAMBORGHINI  
 LAS PISTAS CON CADENA DE PASO 125 MM ADAPTABLE LAMBORGHINI

Art./Ref.	Passo/Pitch	Maglie/Links	Note/Notes	Brand	Applicazione/Application	Rif. Orig./Orig. Ref.	Immagine/Image
18209	125	33	Catena passo 125 mm da 33 maglie - Chain pitch 125 mm 33 links - Ref. Berco FT1335/33	LAMBORGHINI	C340-C340L-C340LL-C340CS	-	
15943	125	35	Catena passo 125 mm da 35 maglie - Chain pitch 125 mm 35 links - Ref. Berco FT1335/35		C350-C350L, C483-C483L, C533N-C554	0.007.8939.4, 0.007.8939.4/10	
14165	125	-	Rullo Cpt. 1B con boccola / Tracking Cpt.1B with bushing - Ref. Berco FT3541		1C/CTC/CTL, C226, C230L/LL/S, C235L/LL/S, C340-C340L-C340LL-C340CS, C350-C350L, C352L/S/LS, C362S, C483-C483L, C533N, C554	0.007.8856.4/10	



**CINGOLATURE CON PASSO CATENE DA 125 MM ADATTABILI SAME**

PISTES AVEC CHAINES PITCH 125 MM ADAPTABLE SAME  
 TRACKS WITH PITCH CHAINS 125 MM ADAPTABLE SAME  
 TRACKS MIT PITCH CHAINS 125 MM PASSEND ZU SAME  
 LAS PISTAS CON CADENA DE PASO 125 MM ADAPTABLE SAME

Art./Ref.	Passo/Pitch	Maglie/Links	Note/Notes	Brand	Applicazione/Application	Rif. Orig./Orig. Ref.	Immagine/Image
14167	125	34	Catena passo 125 mm da 34 maglie - Chain pitch 125 mm 34 links - Ref. Berco FT1335/34	SAME	CONDOR C, FALCON C	-	
15943	125	35	Catena passo 125 mm da 35 maglie - Chain pitch 125 mm 35 links - Ref. Berco FT1335/35		SOLAR 55C	0.007.8939.4, 0.007.8939.4/10	
14165	125	-	Rullo Cpt. 1B con boccola / Tracking Cpt.1B with bushing - Ref. Berco FT3541		CONDOR C, FALCON C, FOX 35-45-55, SOLAR 55C	0.007.8856.4/10	
84394	125	-	Suola a 1 costa da 280 mm - Shoe 1 grouser 280 mm - Ref. Berco FT1238/280		-	0.431.9450.0	
16488	125	-	Suola a 1 costa da 300 mm - Shoe 1 grouser 300 mm - Ref. Berco FT1238/300		-	0.168.9411.0/10	

**VITI E BULLONI PER CATENE CON PASSO 125**

VIT ET BOULONS CHAÎNE AVEC PITCH 125  
 SCREWS AND BOLTS CHAIN WITH PITCH 125  
 SCHRAUBEN UND BOLZEN KETTE MIT PITCH 125  
 TORNILLOS Y PERNOS CADENA CON PARCELA 125

Art./Ref.	Passo/Pitch	Note/Notes	Brand	Applicazione/Application	Rif. Orig./Orig. Ref.	Immagine/Image
12718	125	Vite per suola M10x1 - Screw M10X1 x shoe - Ref Berco FT1012	FIAT	355C	5144980, 557155	
14095	125	Dado x suola M10x1 - Nut M10X1 x shoe - Ref. Berco FT1029		355C	5144981, 557156	

**CINGOLATURE CON PASSO CATENE DA 140 MM ADATTABILI FIAT**
*PISTES AVEC CHAINES PITCH 140 MM ADAPTABLE FIAT*
*TRACKS WITH PITCH CHAINS 140 MM ADAPTABLE FIAT*
*TRACKS MIT PITCH CHAINS 140 MM PASSEND ZU FIAT*
*LAS PISTAS CON CADENA DE PASO 140 MM ADAPTABLE FIAT*

Art./Ref.	Passo/Pitch	Maglie/Links	Note/Notes	Brand	Applicazione/Application	Rif. Orig./Orig. Ref.	Immagine/Image	
<b>17156</b>	140	32	Catena passo 140 mm da 32 maglie - Chain pitch 140 mm 32 links - Ref. Berco FT1351/32	<b>FIAT</b>	411-411C-411CI, 431C VIGNETO, 451C MONTAGNA, 455 FIRST TYPE, 455C FIRST TYPE, 455M-455V, 505C-505C SUPER, 505CM MONTAGNA, 505CV VIGNETO, AD4, AG4	580372		
<b>18221</b>	140	33	Catena passo 140 mm da 33 maglie - Chain pitch 140 mm 33 links - Ref. Berco FT1351/33		565, 565C-565CL-565CM, 60.65-60.65 MONTAGNA, 60.75, 60.75-60.75 MONTAGNA, 62.85, 62.85-62.85 MONTAGNA	5112815, 5193482		
<b>16484</b>	140	35	Catena passo 140 mm da 35 maglie - Chain pitch 140 mm 35 links - Ref. Berco FT1351/35		40CA, 555-555C-555M, 605C-605C SUPER-605CM MONTAGNA, 605CS, FL4	580373		
<b>14175</b>	140	36	Catena passo 140 mm da 36 maglie - Chain pitch 140 mm 36 links - Ref. Berco FT1351/36		665C-665CM, 70.65-70.65 MONTAGNA, 70.75-70.75 MONTAGNA, FL4C, FL4CH, FL4D, FL4L, FL4M	4955093, 5112816		
<b>18222</b>	140	37	Catena passo 140 mm da 37 maglie - Chain pitch 140 mm 37 links - Ref. Berco FT1351/37		765C, 80.65, 80.75	5112817, 87661068		
<b>14171</b>	140	-	Rullo Cpt.1B con boccola / Tracking Cpt.1B with bushing - Ref. Berco FT2954		40CA, 505C, 555-555C-555M, 605C, 605CM MONTAGNA, 605CS, 665C-665CM, 70.65-70.65 MONTAGNA, 70.75-70.75 MONTAGNA, 72.85-72.85 MONTAGNA, 765C, 80.65, 80.75-80.75 HD, 82.85M, 88.85 MONTAGNA, FL4-FL4C-FL4CH-FL4D-FL4L-FL4M	4964281, 4993395, 5109814, 5111357, 5193567, 597432, 79048331		
<b>14173</b>	140	-	Rullo Cpt.2B con boccola / Tracking Cpt.2B with bushing - Ref. Berco FT2953		40CA, 505C, 555-555C-555M, 605C, 605CM MONTAGNA, 605CS, 665C-665CM, 70.65-70.65 MONTAGNA, 70.75-70.75 MONTAGNA, 72.85-72.85 MONTAGNA, 765C, 80.65, 80.75-80.75 HD, 82.85M, 88.85 MONTAGNA, FL4-FL4C-FL4CH-FL4D-FL4L-FL4M	4964280, 4974356, 4993394, 5111356, 5193566, 597431		
<b>15970</b>	140	-	Rullo Superiore / Upper roller - Ref. Berco FT1619		40CA, 555-555C-555M, 60.65-60.65 MONTAGNA, 60.75-60.75 MONTAGNA, 605C, 605C SUPER-605CM MONTAGNA, 605CS, 62.85-62.85 MONTAGNA, 665C-665CM, 70.65-70.65 MONTAGNA, 70.75-70.75 MONTAGNA, 72.85-72.85 MONTAGNA, 765C, 80.65, 80.75-80.75 HD, 82.85M, 88.85 MONTAGNA, FL4-FL4C-FL4CH-FL4D-FL4L-FL4M	5193367		

Art./Ref.	Passo/Pitch	Maglie/Links	Note/Notes	Brand	Applicazione/Application	Rif. Orig./Orig. Ref.	Immagine/Image
15974	140	-	Suola a 1 costa da 310 mm - Shoe 1 grouser 310 mm - Ref. Berco FT2066/310	FIAT	41-411C-411CI, 505C SUPER, 505CV VIGNETO, 555-555C, 565- 565C, 60.65, 60.75, 605-605C- 605C SUPER-605CS, 62.85, 665-665C, 70.65, 70.75, 72.85	5193477	
14180	140	-	Suola a 1 costa da 360 mm - Shoe 1 grouser 360 mm - Ref. Berco FT2066/360		451C MONTAGNA, 455M, 505CM MONTAGNA, 555M, 565CL- 565CM, 60.65 MONTAGNA, 60.75 MONTAGNA, 605CM MONTAGNA, 665CM, 70.65 MONTAGNA, 70.75 MONTAGNA, 765C, 80.65, 80.75- 80.75 HD	568251	
14181	140	-	Suola a 1 costa da 400 mm - Shoe 1 grouser 400 mm - Ref. Berco FT2066/400		82.85 M	5115935	
84396	140	-	Suola a 1 costa da 450 mm - Shoe 1 grouser 450 mm - Ref. Berco FT2066/450		82.85 M	5164685	
16482	140	-	Suola a 3 coste da 260 mm - Shoe 3 grousers 260 mm - Ref. Berco FT1234/260		FL4-FL4C-FL4CH-FL4D	573491, 578001, 79049324	
16483	140	-	Suola a 3 coste da 300 mm - Shoe 3 grousers 300 mm - Ref. Berco FT1234/300		FL4 L-FL4 M-FL4	79014081, 79050071	
14177	140	-	Ruota Motrice - Sprocket - Ref. Berco FT746		40CA, 411C-411CI, 431C VIGNETO, 451C MONTAGNA, 455 FIRST TYPE, 455C FIRST TYPE, 455M, 455V, 505C-505C SUPER, 505CM MONTAGNA, 505CV VIGNETO, 555-555C-555M, 60.75-60.75 MONTAGNA, 605C, 605C SUPER- 605CM MONTAGNA, 605CS, AD4- AG4, FL4, FL4C-FL4CH-FL4D	4957406, 566417	
16425	140	-	Ruota Motrice - Sprocket - Ref. Berco FT2291		565C-565CL-565CM, 60.65-60.65 MONTAGNA, 62.85-62.85 MONTA- GNA, 665C-665CM, 70.65-70.65 MONTAGNA, 70.75-70.75 MON- TAGNA, 72.85-72.85 MONTAGNA, 765C, 80.65, 80.75	5112850, 5130451, 5142888	
84398	140	-	Ruota Motrice - Sprocket - Ref. Berco FT3295		80.75 HD, 82.85M, 88.85 MONTAGNA	5153633	
89202	140	37	Catena passo 140 mm da 37 maglie boccola da 41 - Chain pitch 140 mm 37 links bushing 41 - Ref. Berco FT3141/37		80.75, 82.85M	5153656	

**CINGOLATURE CON PASSO CATENE DA 140 MM ADATTABILI NEW HOLLAND**

PISTES AVEC CHAINES PITCH 140 MM ADAPTABLE NEW HOLLAND

TRACKS WITH PITCH CHAINS 140 MM ADAPTABLE NEW HOLLAND

TRACKS MIT PITCH CHAINS 140 MM PASSEND ZU NEW HOLLAND

LAS PISTAS CON CADENA DE PASO 140 MM ADAPTABLE NEW HOLLAND

Art./Ref.	Passo/Pitch	Maglie/Links	Note/Notes	Brand	Applicazione/Application	Rif. Orig./Orig. Ref.	Immagine/Image	
17156	140	32	Catena passo 140 mm da 32 maglie - Chain pitch 140 mm 32 links - Ref. Berco FT1351/32	NEW HOLLAND	HD VAR507, HD VAR531, TK65, TK65F, TK65V, TK75, TK75F, TK75V	87661064		
18221	140	33	Catena passo 140 mm da 33 maglie - Chain pitch 140 mm 33 links - Ref. Berco FT1351/33		TK4030-TK4030F-TK4030V, TK75FA	5193482		
16484	140	35	Catena passo 140 mm da 35 maglie - Chain pitch 140 mm 35 links - Ref. Berco FT1351/35		-	-		
14175	140	36	Catena passo 140 mm da 36 maglie - Chain pitch 140 mm 36 links - Ref. Berco FT1351/36		TK76-TK76M	5112816		
18222	140	37	Catena passo 140 mm da 37 maglie - Chain pitch 140 mm 37 links - Ref. Berco FT1351/37		-	-		
14171	140	-	Rullo Cpt.1B con boccola / Tracking Cpt.1B with bushing - Ref. Berco FT2954		TK4030-TK4030F-TK4030V, TK4040-TK4040M, TK4050, TK75F-TK75FA, TK76-TK76M, TK80A-TK80MA, TK85-TK85M, TK90A-TK90MA	5111357, 5193567, 87661070		
14173	140	-	Rullo Cpt.2B con boccola / Tracking Cpt.2B with bushing - Ref. Berco FT2953		TK4030F-TK4030V, TK4040-TK4040M, TK4050, TK75F-TK75FA, TK76-TK76M, TK80A-TK80MA, TK85-TK85M, TK90A-TK90MA	5111356, 5193566, 87661069		
15970	140	-	Rullo Superiore / Upper roller - Ref. Berco FT1619		HD VAR531, TK65F, TK75F-TK75FA, TK76-TK76M, TK80A-TK80MA, TK85-TK85M, TK90A-TK90MA, TK95M	5193367		
84397	140	-	Rullo superiore con albero - Upper roller shaft - Ref. Berco LA337		DC70 LGP	-		

Art./Ref.	Passo/Pitch	Maglie/Links	Note/Notes	Brand	Applicazione/Application	Rif. Orig./Orig. Ref.	Immagine/Image
15974	140	-	Suola a 1 costa da 310 mm - Shoe 1 grouser 310 mm - Ref. Berco FT2066/310	NEW HOLLAND	TF4030-TK4030F, TK4040, TK65 HD VAR531, TK65F, TK75-TK75F- TK75FA, TK76, TK80-TK80A, TK85, TK90-TK90A	5193477	
14181	140	-	Suola a 1 costa da 400 mm - Shoe 1 grouser 400 mm - Ref. Berco FT2066/400		TK85M, TK90MA	5193466	
84396	140	-	Suola a 1 costa da 450 mm - Shoe 1 grouser 450 mm - Ref. Berco FT2066/450		TK85M, TK90MA	5164685	
16425	140	-	Ruota Motrice - Sprocket - Ref. Berco FT2291		TK4040, TK76-TK76M	5142888	
84398	140	-	Ruota Motrice - Sprocket - Ref. Berco FT3295		TK100A, TK4040M, TK4050- TK4050M, TK4060, TK80A- TK80MA, TK85-TK85M, TK90A-TK90MA, TK95M	5153633	
89201	140	36	Catena passo 140 mm da 36 maglie boccola da 41 - Chain pitch 140 mm 36 links bushing 41 - Ref. Berco FT3141/36		TK4030 - TK4030F - TK4030V, TK4040 - TK4040M, TK4050, TK76 - TK76M, TK80A - TK80MA, TK90A - TK90MA	5193479	
89202	140	37	Catena passo 140 mm da 37 maglie boccola da 41 - Chain pitch 140 mm 37 links bushing 41 - Ref. Berco FT3141/37		TK4030 - TK4030F - TK4030V, TK4040 - TK4040M, TK4050, TK80A - TK80MA, TK85 - TK85M, TK90A - TK90MA	5193480	
15981	140	-	Rullo Cpt.1B con boccola / Tracking Cpt.1B with bushing - Ref. Berco FT3768		TK100A, TK4050M, TK4060, TK95M	5182732	
15982	140	-	Rullo Cpt.2B con boccola / Tracking Cpt.2B with bushing - Ref. Berco FT3769		TK100A, TK4050M, TK4060, TK95M	5182733	
84429	140	-	Suola a 1 costa da 450 mm - Shoe 1 grouser 450 mm - Ref. Berco LA217/450		TK100A, TK4050M, TK4060, TK95M	5184225, 5193340	

**CINGOLATURE CON PASSO CATENE DA 140 MM ADATTABILI LANDINI**
*PISTES AVEC CHAINES PITCH 140 MM ADAPTABLE LANDINI*
*TRACKS WITH PITCH CHAINS 140 MM ADAPTABLE LANDINI*
*TRACKS MIT PITCH CHAINS 140 MM PASSEND ZU LANDINI*
*LAS PISTAS CON CADENA DE PASO 140 MM ADAPTABLE LANDINI*

Art./Ref.	Passo/Pitch	Maglie/Links	Note/Notes	Brand	Applicazione/Application	Rif. Orig./Orig. Ref.	Immagine/Image
<b>17156</b>	140	32	Catena passo 140 mm da 32 maglie Chain pitch 140 mm 32 links - Ref. Berco FT1351/32	<b>LANDINI</b>	C4500, C5000, CL5000 SPECIAL	975865M91	
<b>18221</b>	140	33	Catena passo 140 mm da 33 maglie - Chain pitch 140 mm 33 links - Ref. Berco FT1351/33		5500-5500M-5500S, 5830C-5830CL-5830CS, 6030C-6030CL-6030CS, 6060-6060L-6060S	3538968M91	
<b>16484</b>	140	35	Catena passo 140 mm da 35 maglie - Chain pitch 140 mm 35 links - Ref. Berco FT1351/35		6500-6500M-6500S, 6830-6830C-6830CL	1825107M91, 3531482M91, 3538965M91	
<b>14175</b>	140	36	Catena passo 140 mm da 36 maglie - Chain pitch 140 mm 36 links - Ref. Berco FT1351/36		C14000MARK II, C15000	973501M91	
<b>18222</b>	140	37	Catena passo 140 mm da 37 maglie - Chain pitch 140 mm 37 links - Ref. Berco FT1351/37		CF85 LARGO, CF85 STD, TREKKER 65F, TREKKER 65F MONTAGNA, TREKKER 75F, TREKKER 75F MONTAGNA, TREKKER 75F STD, TREKKER 80F	3542025M91	
<b>14171</b>	140	-	Rullo Cpt.1B con boccola / Tracking Cpt.1B with bushing - Ref. Berco FT2954		6500-6500M-6500S, 6830C-6830CL, C6000, CF85 LARGO-CF85 STD, C14000 MARK II, C15000, CL6000, TREKKER 65F-65F MONTAGNA, TREKKER 75F-75F MONTAGNA, TREKKER 75FS, TREKKER 80F	3538901M91	
<b>14173</b>	140	-	Rullo Cpt.2B con boccola / Tracking Cpt.2B with bushing - Ref. Berco FT2953		6500-6500M-6500S, 6830C-6830CL, C6000, C6830, CF85 LARGO-CF85 STD, C14000 MARK II, C15000, CL6000, TREKKER 65F-65F MONTAGNA, TREKKER 75F-75F MONTAGNA, TREKKER 75FS, TREKKER 80F	3538902M91	
<b>15970</b>	140	-	Rullo Superiore / Upper roller - Ref. Berco FT1619		5500-5500M-5500S, 5830C-5830CL-5830CS, 6030C-6030CL-6030CS, 6060-6060L-6060S, 6500-6500M-6500S, 6830C-6830CL, C4500, CF85 LARGO-CF85 STD, TREKKER 100F-100M, TREKKER 105F-105M, TREKKER 65F-65F MONTAGNA, TREKKER 75F-75F MONTAGNA, TREKKER 75FSTD, TREKKER 80F-80F MONTAGNA, TREKKER 85F LARGO, TREKKER 85F/R MONTAGNA, TREKKER 85FSTD, TREKKER 90F-M, TREKKER 95STD	3311678M91, 3531605M91, 3538489M91	
<b>84397</b>	140	-	Rullo superiore con albero - Upper roller shaft - Ref. Berco LA337		7500, 7800, 7830-7830L-7830S, 8860, C5000, C6000, CL6000	1432374M91, 1438039M91, 3531829M91	

Art./Ref.	Passo/Pitch	Maglie/Links	Note/Notes	Brand	Applicazione/Application	Rif. Orig./Orig. Ref.	Immagine/Image
15974	140	-	Suola a 1 costa da 310 mm - Shoe 1 grouser 310 mm - Ref. Berco FT2066/310	LANDINI	5500-5500S, 5830C-5830CS, 6030C-6030CS, 6060- 6060S, 6500-6500S, 6830C, C4500-C5000-C6000, CL5000 SPECIAL, CL6000, TREKKER 65F	973691M1	
14180	140	-	Suola a 1 costa da 360 mm - Shoe 1 grouser 360 mm - Ref. Berco FT2066/360		5500M, 5830CL, 6030CL, 6060L, 6500M, 6830CL, CF85 STD, TREKKER 65F MONTAGNA, TREKKER 75F-75F STD, TREKKER 80F	977760M1	
14181	140	-	Suola a 1 costa da 400 mm - Shoe 1 grouser 400 mm - Ref. Berco FT2066/400		CF85 LARGO, TREKKER 75F MONTAGNA	3546060M1	
84396	140	-	Suola a 1 costa da 450 mm - Shoe 1 grouser 450 mm - Ref. Berco FT2066/450		CF85 LARGO, TREKKER 75F MONTAGNA	-	
16482	140	-	Suola a 3 coste da 260 mm - Shoe 3 grousers 260 mm - Ref. Berco FT1234/260		CI4000 MARK II, CI5000	-	
72706	140	-	Ruota Motrice - Sprocket - Ref. Berco LA459		5500-5500M-5500S, 5830C- 5830CL-5830CS, 6030C-6030CL- 6030CS, 6060-6060L-6060S, 6500-6500M-6500S, 6830C- 6830CL	1824729M1	
89204	140	-	Ruota Motrice - Sprocket - Ref. Berco LA537		TREKKER 100 F, TREKKER 100 M, TREKKER 105 F, TREKKER 105 M, TREKKER 80 F MONTAGNA, TREKKER 85 F LARGO, TREKKER 85 F STD, TREKKER 85 F-R MON- TAGNA, TREKKER 90 F, TREKKER 90 M, TREKKER 95 STD	3539458M2	
89203	140	36	Catena passo 140 mm da 36 maglie - Chain pitch 140 mm 36 links - Ref. Berco LA308/36		7500, 7800, 7830 - 7830L - 7830S, 8860	1428051M91, 3306376M91, 3531474M91, 3533777M91, 3538949M91	
58301	140	37	Catena passo 140 mm da 37 maglie - Chain pitch 140 mm 37 links - Ref. Berco LA308/37		TREKKER 100F-100M, TREKKER 105F-105M, TREKKER 80F MON- TAGNA, TREKKER 90F-90M	3542028M91	
15981	140	-	Rullo Cpt.1B con boccola / Tracking Cpt.1B with bushing - Ref. Berco FT3768		7500, 7800, 7830-7830L-7830S, 8860, TREKKER 100F, TREKKER 100M, TREKKER 105F, TREKKER 105M, TREKKER 80F MONTAGNA, TREKKER 85F LARGO, TREKKER 85F STD, TREKKER 85F/R MON- TAGNA, TREKKER 90 M, TREKKER 90F, TREKKER 95STD	3218024M91, 3218027M91, 3539029M91	

Art./Ref.	Passo/Pitch	Maglie/Links	Note/Notes	Brand	Applicazione/Application	Rif. Orig./Orig. Ref.	Immagine/Image
<b>15982</b>	140	-	Rullo Cpt.2B con boccola / Tracking Cpt.2B with bushing - Ref. Berco FT3769	<b>LANDINI</b>	7500, 7800, 7830-7830L-7830S, 8860, TREKKER 100F, TREKKER 100M, TREKKER 105F, TREKKER 105M, TREKKER 80F MONTAGNA, TREKKER 85F LARGO, TREKKER 85F STD, TREKKER 85F/R MONTAGNA, TREKKER 90F, TREKKER 90M, TREKKER 95STD	3218026M91, 3531417M91, 3539028M91	
<b>84431</b>	140	-	Suola a 1 costa da 360 mm - Shoe 1 grouser 360 mm - Ref. Berco LA217/360		7830, TREKKER 100, TREKKER 105, TREKKER 90	1844114M1	
<b>15988</b>	140	-	Suola a 1 costa da 400 mm - Shoe 1 grouser 400 mm - Ref. Berco LA217/400		7500, 7800, 7830-7830L, 8860, TREKKER 100M, TREKKER 105M, TREKKER 80F MONTAGNA, TREKKER 85F STD, TREKKER 90M	3300455M1	
<b>84429</b>	140	-	Suola a 1 costa da 450 mm - Shoe 1 grouser 450 mm - Ref. Berco LA217/450		TREKKER 85F LARGO, TREKKER 85F/R MONTAGNA, TREKKER 95STD	3546225M1	

**CINGOLATURE CON PASSO CATENE DA 140 MM ADATTABILI MASSEY FERGUSON**

PISTES AVEC CHAINES PITCH 140 MM ADAPTABLE MASSEY FERGUSON  
 TRACKS WITH PITCH CHAINS 140 MM ADAPTABLE MASSEY FERGUSON  
 TRACKS MIT PITCH CHAINS 140 MM PASSEND ZU MASSEY FERGUSON  
 LAS PISTAS CON CADENA DE PASO 140 MM ADAPTABLE MASSEY FERGUSON

Art./Ref.	Passo/Pitch	Maglie/Links	Note/Notes	Brand	Applicazione/Application	Rif. Orig./Orig. Ref.	Immagine/Image
<b>17156</b>	140	32	Catena passo 140 mm da 32 maglie - Chain pitch 140 mm 32 links - Ref. Berco FT1351/32	<b>MASSEY FERGUSON</b>	-	975865M91	
<b>18221</b>	140	33	Catena passo 140 mm da 33 maglie - Chain pitch 140 mm 33 links - Ref. Berco FT1351/33		MF154C-MF154CL-MF154CS, MF254C-MF254CL-MF254CS, MF264C-MF264CL-MF264CS, MF364C-MF364CF LARGO, MF364CF STRETTO	3538968M91	
<b>16484</b>	140	35	Catena passo 140 mm da 35 maglie - Chain pitch 140 mm 35 links - Ref. Berco FT1351/35		MF174C-MF174CL-MF174CS, MF274CF-MF274CF LARGO	3531482M91, 3538965M91	
<b>14175</b>	140	36	Catena passo 140 mm da 36 maglie - Chain pitch 140 mm 36 links - Ref. Berco FT1351/36		MF2244DOZER, MF2244LOADER, MF244, MF244 MARK II	973501M91	
<b>14171</b>	140	-	Rullo Cpt.1B con boccola / Tracking Cpt.1B with bushing - Ref. Berco FT2954		MF154C-MF154CL-MF154CS, MF174C-MF174CL-MF174CS, MF2244 DOZER-LOADER, MF244-MF244 MARK II, MF254C-MF254CL-MF254CS, MF264C-MF264CL-MF264CS, MF274CF-MF274CF LARGO, MF364CF STRETTO, MF364CF-MF364CF LARGO	3538901M91	
<b>14173</b>	140	-	Rullo Cpt.2B con boccola / Tracking Cpt.2B with bushing - Ref. Berco FT2953		MF154C-MF154CL-MF154CS, MF174C-MF174CL-MF174CS, MF2244 DOZER-LOADER, MF244-MF244 MARK II, MF274CF-MF274CF LARGO	3538902M91	



Art./Ref.	Passo/Pitch	Maglie/Links	Note/Notes	Brand	Applicazione/Application	Rif. Orig./Orig. Ref.	Immagine/Image
15970	140	-	Rullo Superiore / Upper roller - Ref. Berco FT1619	MASSEY FERGUSON	MF154C-MF154CL-MF154CS, MF174C-MF174CL-MF174CS, MF254C-MF254CL-MF254CS, MF264C- MF264CL-MF264CS, MF274CF- MF274CF LARGO, MF364CF STRETTO, MF364CF-MF364CF LARGO	1825153M91, 3538489M91	
84397	140	-	Rullo superiore con albero - Upper roller shaft - Ref. Berco LA337		MF194C, MF200 DOZER-LOADER, MF200B-MF200C-MF200D, MF2244 DOZER-LOADER, MF244-MF244 MARK II, MF250, MF294C, MF330	3531829M91	
15974	140	-	Suola a 1 costa da 310 mm - Shoe 1 grouser 310 mm - Ref. Berco FT2066/310		MF154-MF154C-MF154CS, MF174- MF174C-MF174CS, MF2244 DOZER, MF254-MF254C-MF254CS, MF264- MF264C-MF264CS, MF274-MF274CS, MF364CF-MF364CF STRETTO	973691M1	
14180	140	-	Suola a 1 costa da 360 mm - Shoe 1 grouser 360 mm - Ref. Berco FT2066/360		MF154CL, MF174CL, MF254CL, MF264CL, MF274CF LARGO, MF364CF LARGO	977760M1	
16482	140	-	Suola a 3 coste da 260 mm - Shoe 3 grousers 260 mm - Ref. Berco FT1234/260		MF2244 LOADER, MF244-MF244 MARK II	-	
72706	140	-	Ruota Motrice - Sprocket - Ref. Berco LA459		MF154C-MF154CL-MF154CS, MF174C-MF174CL-MF174CS, MF254C-MF254CL-MF254CS, MF264C- MF264CL-MF264CS, MF274CF- MF274CF LARGO, MF364CF STRETTO, MF364CF-MF364CF LARGO	1824729M1	
89204	140	-	Ruota Motrice - Sprocket - Ref. Berco LA537		3435 C, 396, 396 T	3539458M2	
89203	140	36	Catena passo 140 mm da 36 maglie - Chain pitch 140 mm 36 links - Ref. Berco LA308/36		MF194C, MF200 DOZER, MF200 LOA- DER, MF200B - MF200C, MF294C	1428051M91, 3306376M91, 3531474M91, 3533777M91, 3538949M91	
58301	140	37	Catena passo 140 mm da 37 maglie - Chain pitch 140 mm 37 links - Ref. Berco LA308/37		MF200D	3542028M91	
15981	140	-	Rullo Cpt.1B con boccola / Tracking Cpt.1B with bushing - Ref. Berco FT3768		MF194C, MF200 DOZER-LOADER, MF200B, MF200C, MF200D, MF250, MF294C, MF330	3304405M91, 3539029M91	
15982	140	-	Rullo Cpt.2B con boccola / Tracking Cpt.2B with bushing - Ref. Berco FT3769		MF194C, MF200 DOZER-LOADER, MF200B, MF200C, MF200D, MF250, MF294C, MF330	1428037M91, 1428260M91, 3304404M91, 3539028M91	
84430	140	-	Suola a 1 costa da 310 mm - Shoe 1 grouser 310 mm - Ref. Berco LA217/310		MF200 DOZER	1844113M1	
84431	140	-	Suola a 1 costa da 360 mm - Shoe 1 grouser 360 mm - Ref. Berco LA217/360		MF394C	1844114M1, 3304061M1	
15988	140	-	Suola a 1 costa da 400 mm - Shoe 1 grouser 400 mm - Ref. Berco LA217/400	MF194C, MF294C	3304062M1		

**CINGOLATURE CON PASSO CATENE DA 140 MM ADATTABILI LAMBORGHINI**

PISTES AVEC CHAINES PITCH 140 MM ADAPTABLE LAMBORGHINI

TRACKS WITH PITCH CHAINS 140 MM ADAPTABLE LAMBORGHINI

TRACKS MIT PITCH CHAINS 140 MM PASSEND ZU LAMBORGHINI

LAS PISTAS CON CADENA DE PASO 140 MM ADAPTABLE LAMBORGHINI

Art./Ref.	Passo/Pitch	Maglie/Links	Note/Notes	Brand	Applicazione/Application	Rif. Orig./Orig. Ref.	Immagine/Image
<b>17156</b>	140	32	Catena passo 140 mm da 32 maglie - Chain pitch 140 mm 32 links - Ref. Berco FT1351/32	<b>LAMBORGHINI</b>	C345-C345L-C345LL-C345S, C355-C355L, C503-C503L/LL/S, C553L/LL/S, C583L/S	0.424.9450.4	
<b>19221</b>	140	33	Catena passo 140 mm da 33 maglie - Chain pitch 140 mm 33 links - Ref. Berco FT1351/33		C603 /L	-	
<b>16484</b>	140	35	Catena passo 140 mm da 35 maglie - Chain pitch 140 mm 35 links - Ref. Berco FT1351/35		C674/L/N, C684/L	0.007.9463.4 0.191.9450.4	
<b>14171</b>	140	-	Rullo Cpt.1B con boccola / Tracking Cpt.1B with bushing - Ref. Berco FT2954		C345-C345L-C345LL-C345S, C355-C355L, C503-C503L/LL/S, C553L/LL/S, C583L/S, C603/L, C653/L, C674/L/N, C683/L, C684/L	0.007.9446.4, 0.216.9215.3, 0.424.9215.4	
<b>14173</b>	140	-	Rullo Cpt.2B con boccola / Tracking Cpt.2B with bushing - Ref. Berco FT2953		C603/L, C653/L, C674/L-N, C683/L, C684/L	0.007.9445.4/10, 0.216.9214.3, 0.424.9214.4	
<b>84397</b>	140	-	Rullo superiore con albero - Upper roller shaft - Ref. Berco LA337		C105, C350/L, C352L/S/SL, C453/L, C553/L/LL, C583L, C603/L, C653/L, C674/L/N, C683/L, C684/L, C754/L, C774, C784L, C874	0.007.8857.4/10, 0.216.9230.4, 0.292.9230.4	
<b>14177</b>	140	-	Ruota Motrice - Sprocket - Ref. Berco FT746		MINITAURO 60C, TAURUS C	-	
<b>84399</b>	140	-	Ruota Motrice - Sprocket - Ref. Berco LB146		C105, C754/L, C774/80, C784L, C874/90	0.294.9210.0	
<b>58301</b>	140	37	Catena passo 140 mm da 37 maglie - Chain pitch 140 mm 37 links - Ref. Berco LA308/37		C105, C754/L, C774, C784L, C874/90	0.007.8946.4, 0.216.9450.4	
<b>15981</b>	140	-	Rullo Cpt.1B con boccola / Tracking Cpt.1B with bushing - Ref. Berco FT3768		C105, C754/L, C774, C784/L, C874/90	0.007.9359.4	
<b>15982</b>	140	-	Rullo Cpt.2B con boccola / Tracking Cpt.2B with bushing - Ref. Berco FT3769		C105, C754/L, C774, C784/L, C874/90	0.007.9358.4	

**CINGOLATURE CON PASSO CATENE DA 140 MM ADATTABILI SAME**

PISTES AVEC CHAINES PITCH 140 MM ADAPTABLE SAME

TRACKS WITH PITCH CHAINS 140 MM ADAPTABLE SAME

TRACKS MIT PITCH CHAINS 140 MM PASSEND ZU SAME

LAS PISTAS CON CADENA DE PASO 140 MM ADAPTABLE SAME

Art./Ref.	Passo/Pitch	Maglie/Links	Note/Notes	Brand	Applicazione/Application	Rif. Orig./Orig. Ref.	Immagine/Image	
17156	140	32	Catena passo 140 mm da 32 maglie - Chain pitch 140 mm 32 links - Ref. Berco FT1351/32	SAME	SOLAR 60C	0.424.9450.4		
16484	140	35	Catena passo 140 mm da 35 maglie - Chain pitch 140 mm 35 links - Ref. Berco FT1351/35		EXPLORER 65C, EXPLORER 70C	0.007.9463.4, 0.191.9450.4		
14175	140	36	Catena passo 140 mm da 36 maglie - Chain pitch 140 mm 36 links - Ref. Berco FT1351/36		MINITAURO 60C, TAURUS C	-		
14171	140	-	Rullo Cpt.1B con boccola / Tracking Cpt.1B with bushing - Ref. Berco FT2954		EXPLORER 65C-75C-70C, MINITAURO 60C, SOLAR 60C, TAURUS C	0.007.9446.4, 0.216.9215.3, 0.424.9215.4		
14173	140	-	Rullo Cpt.2B con boccola / Tracking Cpt.2B with bushing - Ref. Berco FT2953		EXPLORER 65C-75C-70C, MINITAURO 60C, TAURUS C	0.007.9445.4/10, 0.216.9214.3, 0.424.9214.4		
15970	140	-	Rullo Superiore / Upper roller - Ref. Berco FT1619		EXPLORER 65C-75C-70C, SOLAR 60C	-		
84397	140	-	Rullo superiore con albero - Upper roller shaft - Ref. Berco LA337		CONDOR C, EXPLORER 90C, FOX 45-55, KRIPTON F98C, MINITAURO 60C, SOLAR 55C, TAURUS C	0.007.8857.4/10, 0.216.9230.4, 0.292.9230.4		
15974	140	-	Suola a 1 costa da 310 mm - Shoe 1 grouser 310 mm - Ref. Berco FT2066/310		-	-	0.425.9411.0	
14180	140	-	Suola a 1 costa da 360 mm - Shoe 1 grouser 360 mm - Ref. Berco FT2066/360		-	-	0.160.9412.0, 0.425.9412.0	

Art./Ref.	Passo/Pitch	Maglie/Links	Note/Notes	Brand	Applicazione/Application	Rif. Orig./Orig. Ref.	Immagine/Image
84399	140	-	Ruota Motrice - Sprocket - Ref. Berco LB146	SAME	EXPLORER 80C-90C, KRYPTON 105, LEOPARD C	0.294.9210.0	
58301	140	37	Catena passo 140 mm da 37 maglie - Chain pitch 140 mm 37 links - Ref. Berco LA308/37		EXPLORER 75C, EXPLORER 80C-90C, LEOPARD C	0.007.8946.4, 0.216.9450.4	
15981	140	-	Rullo Cpt.1B con boccola / Tracking Cpt.1B with bushing - Ref. Berco FT3768		EXPLORER 80C, EXPLORER 90C, LEOPARD C	0.007.9359.4	
15982	140	-	Rullo Cpt.2B con boccola / Tracking Cpt.2B with bushing - Ref. Berco FT3769		EXPLORER 80C, EXPLORER 90C, KRYPTON F98C, LEOPARD C	0.007.9358.4	
15988	140	-	Suola a 1 costa da 400 mm - Shoe 1 grouser 400 mm - Ref. Berco LA217/400		-	0.216.9451.0	
84429	140	-	Suola a 1 costa da 450 mm - Shoe 1 grouser 450 mm - Ref. Berco LA217/450		-	0.007.8817.0	

**VITI E BULLONI PER CATENE CON PASSO 140**
*VIT ET BOULONS CHAÎNE AVEC PITCH 140*
*SCREWS AND BOLTS CHAIN WITH PITCH 140*
*SCHRAUBEN UND BOLZEN KETTE MIT PITCH 140*
*TORNILLOS Y PERNOS CADENA CON PARCELA 140*

Art./Ref.	Passo/Pitch	Note/Notes	Brand	Applicazione/Application	Rif. Orig./Orig. Ref.	Immagine/Image
12806	140	Vite per suola M12x1 - Screw M12X1 x shoe - Ref Berco FT694	FIAT	605C, FL4	5117440, 571894	
12804	140	Dado x suola M12x1 - Nut M12X1 x shoe - Ref. Berco FT887		605C, FL4	5117441, 571946, 79031163	

## SOPRASSUOLE IN GOMMA

PATIN DE ROUTE  
RUBBER ROAD PADS  
STRASSEN PLATTEN  
PATIN DE CARRETERA

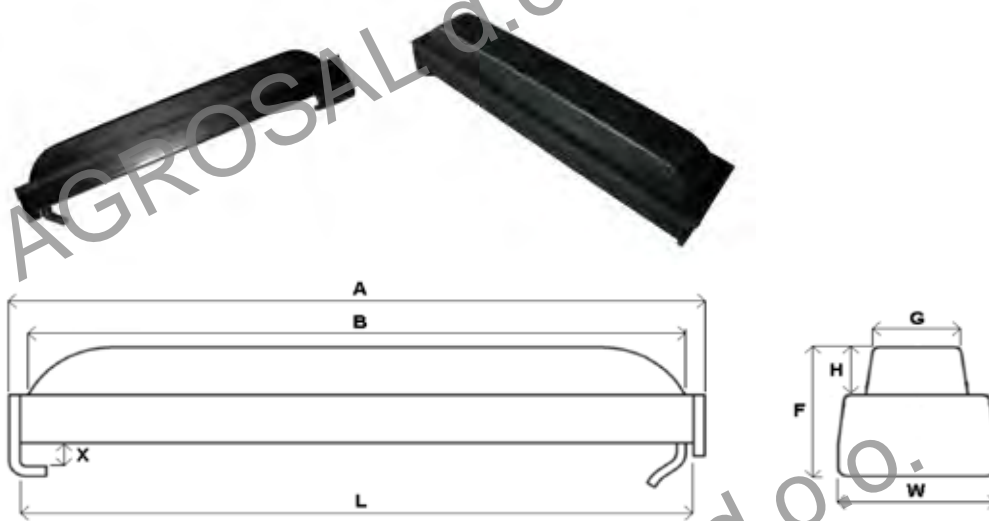

Art./Ref.	Passo/Pitch	Note/Note	A mm	B mm	G mm	H mm	L mm	W mm	X mm
59826	140	Soprasuola in gomma da 310 mm - Rubber Road Pads 310 mm	325	305	47	29	361	85	12
64011	140	Soprasuola in gomma da 350 mm - Rubber Road Pads 350 mm	365	345	47	29	361	85	12
59828	140	Soprasuola in gomma da 360 mm - Rubber Road Pads 360 mm	375	355	47	29	361	85	12
59829	140	Soprasuola in gomma da 400 mm - Rubber Road Pads 400 mm	415	395	47	29	361	85	12
75395	140	Soprasuola in gomma da 450 mm - Rubber Road Pads 450 mm	465	445	47	29	361	85	12



## 1.7.23 Cingoli in gomma

Rubber tracks



**ama**

**Ricambi & accessori per macchine agricole**  
SPARE PARTS & ACCESSORIES FOR AGRICULTURAL MACHINE

Tutti gli articoli della presente sezione, prodotti da AMA SPA e/o da terzi per conto di AMA, sono adattabili ("non originali") alle marche indicate ai sensi di quanto previsto dal REG. CE n. 1400/2002. I diritti sui marchi citati appartengono ai legittimi proprietari e il loro uso ha l'esclusiva finalità di consentire all'utilizzatore la comparazione dei diversi prodotti. All items of this section, manufactured by AMA SPA and/or any third party on behalf of AMA, are adaptable ("non-original") to the brands listed under the provisions of the REG. CE n. 1400/2002. The rights on the trademarks belong to their respective owners and their usage is only aimed to allow the user to compare different products.

**TECHNICAL DATA RUBBER TRACKS - INFORMAZIONI DATI CINGOLI IN GOMMA**

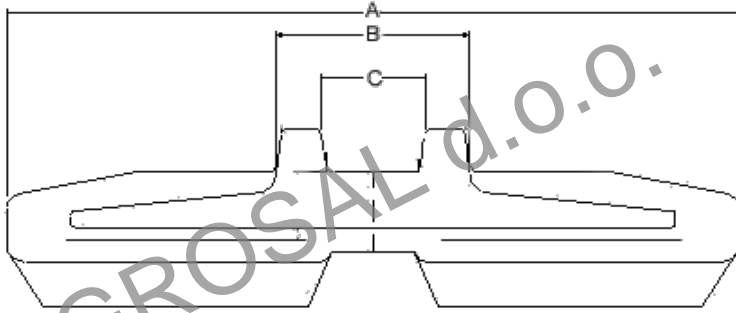

- A:** Rubber track width (mm.)  
Larghezza del cingolo (mm.)
- B:** External rail guide width (mm.)  
Larghezza pista esterna (mm.)
- C:** Inner rail guide width (mm.)  
Larghezza pista interna (mm.)

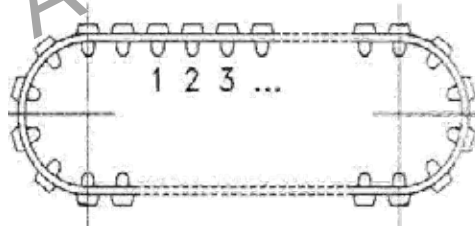

**No:** - Number of links  
**N°:** - Numero elementi

**Pitch:** Interaxe between two elements (millimeter)

**Passo:** Misura in millimetri tra due elementi

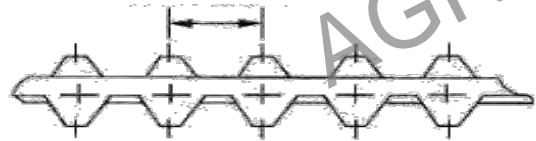

**GUIDE ROLLER TYPE FOR RUBBER TRACKS - TIPO GUIDA RULLO PER CINGOLI IN GOMMA**

**PITCH: CONVENTIONAL TYPE - PASSO: TIPO CONVENZIONALE**

**INNER FLANGE TRACK ROLLER RULLO GUIDA**

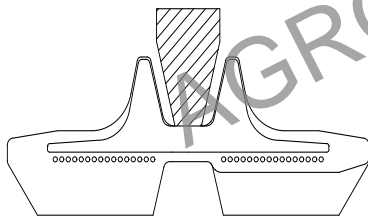

**OUTER FLANGE TRACK ROLLER RULLO GUIDA**

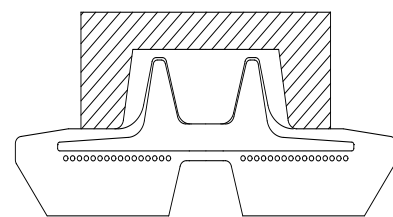

**PITCH: INTERCHANGEABLE TYPE - PASSO: TIPO INTERCAMBIABILE**

**INNER FLANGE TRACK ROLLER RULLO GUIDA**

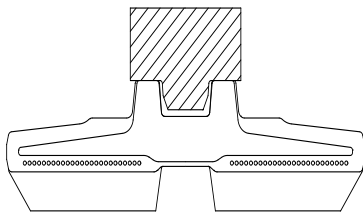

**LOW OUTER FLANGE TRACK ROLLER RULLO GUIDA ESTERNA**

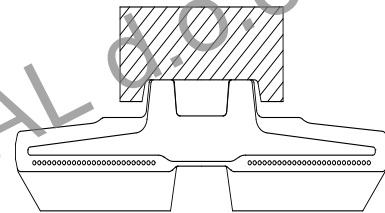

**"RAIL TYPE" OUTER FLANGE TRACK ROLLER RULLO GUIDA ESTERNA ALTA**

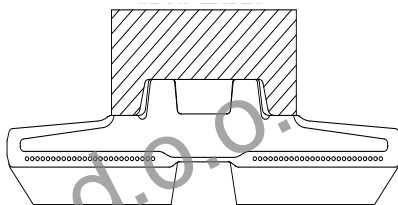

**"RAIL TYPE" OUTER FLANGE TRACK ROLLER RULLO GUIDA ESTERNA ALTA**

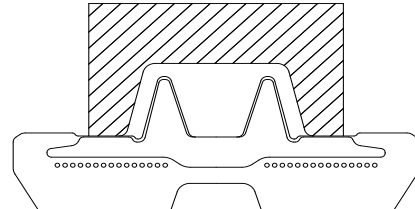

**"RAIL TYPE" OUTER DOUBLE FLANGE TRACK ROLLER RULLO DOPPIO BORDO GUIDA ESTERNA ALTA "RAIL"**

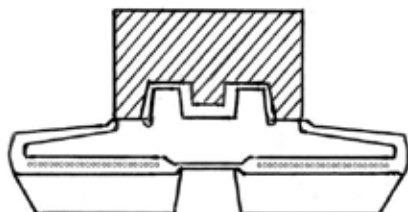

**LOW OUTER DOUBLE FLANGE TRACK ROLLER RULLO DOPPIO BORDO GUIDA ESTERNA**

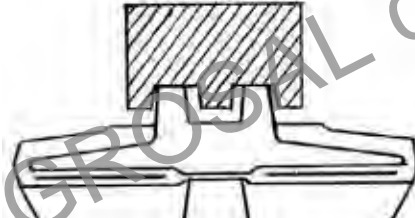



## CINGOLI IN GOMMA ADATTABILI

CHENILLE CAOUTCHOUC ADAPTABLE

RUBBER TRACKING ADAPTABLE TO

GUMMIRAUPEN PASSEND ZU

ORUGA DE GOMA ADAPTABLE



Brand	Art./Ref.	Misura/Size	Applicazione/Application	
AICHI	28326	230 X 72 X 43	DM10	
	28327	230 X 72 X 42	RV040, RV041	
	62248	230 X 72 X 50	RV042	
	62357	300 X 55 X 82	FR300AA	
AIRMANN	28344	180 X 72 X 36	HM07S	
	28329	180 X 72 X 37	AX05, AX08, AX08.2	
	62216	180 X 72 X 40	AX10U	
	62227	200 X 72 X 40	AX10U	
	28327	230 X 72 X 42	HM 15.5	
	28330	230 X 96 X 31	AX12, AX12.2, AX15, AX15.2, AXC12, AXC15	
	28331	230 X 96 X 33	AX16, AX16.2, AX16.2N, AX16CBL.3, AX17, AX17-2, AX17-2N, AX17CGL.2N, HM10, HM15	
	84571	230 X 96 X 35	AX17U	
	62257	250 X 52,5 X 73N	AX18.2, AX22, AX22.2, AX22CGL, AX25.3	
	84577	250 X 52,5 X 78N	AX20UR, AX20UR.3	
	62277	250 X 96 X 41	AX20U	
	62316	300 X 52,5 X 72N	AX22	
	62322	300 X 52,5 X 76N	AX25, AX25.1, AX25.2, AX30UR, AX30UR.1, AX30UR.2	
	62325	300 X 52,5 X 78N	AX27, AX27U, AX29U, AX29UCGL	
	62328	300 X 52,5 X 80N	AX35.2	
	62331	300 X 52,5 X 82N	AX30.1, AX30.2, AX30UR.3, AX32U, AX33MU, AX33U, AX35, AX35.2, AX35CGL.3	
	62332	300 X 52,5 X 82W	HM30SGZ, HM30SZG	
	62337	300 X 52,5 X 86N	AX30U.4, AX30UR.4, AX35U, AX36U, AX36UCGL	
	62338	300 X 52,5 X 86W	HM35	
	62353	300 X 55 X 74	AX25, AX25.1, AX25.2, AX30UR, AX30UR.1, AX30UR.2	
	62356	300 X 55 X 80	AX30, AX30.1, AX30.2, AX30UR.3, AX32U, AX33MU, AX33U, AX35, AX35.1	
	62286	300 X 109 X 35N	AX22	
	62302	300 X 109 X 40W	HM30SGZ, HM30SZG	
	62308	300 X 109 X 42W	HM35	
	62362	320 X 100 X 38	HM20, HM20S, HM20S, HM20SCG.2, HM20SG.2, HM20SMG.2	
	62363	320x100x40.	HM25	
	62367	320 X 100 X 44	HM30, HM30SCG.2	
	62413	400 X 72,5 X 72W	AX40, AX40.2, AX40SR, AX40U, AX40UR.1, AX40UR.2, AX45, AX45.2, AX50, AX50.2, AX50SR, AX50U, AX50UCGL, AX55UR, AX55UR3, HM45, HM45.2, HM50, HM55	
	62417	400 X 72,5 X 74KW	AX58MU	
	62419	400 X 72,5 X 74W	AX58MU	
	ANTEC	28329	180 X 72 X 37	HCC1051D
		28326	230 X 72 X 43	A12B, A14SA
62248		230 X 72 X 50	HCC2051	
62271		250 X 72 X 50	HCC2051	
APAFOR	28326	230 X 72 X 43	30	
ATEX	62211	180 X 72 X 33	500	
	84523	200 X 72 X 38	XC750D	
ATLAS	28335	180 X 72 X 34	CT045	
	28329	180 X 72 X 37	1507, CT7NX	
	28346	200 X 72 X 34	CT045	

Brand	Art./Ref.	Misura/Size	Applicazione/Application
ATLAS	62228	200 X 72 X 41	100, 100B, CT, CT100
	28332	230 X 72 X 41	110, 1104, CT, CT100, CT100R, CT150, CT150R, CT200R
	28327	230 X 72 X 42	120AB, CT120
	28326	230 X 72 X 43	120, 120RF, 404, 404R, CT10N, CT120, CT12N
	28331	230 X 96 X 35	404.2
	62271	250 X 72 X 50	1004
	62276	250 X 72 X 57	604, 604R
	62320	300 X 52,5 X 74W	CT27N
	62328	300 X 52,5 X 80N	CT30N
	62290	300 X 109 X 36W	CT27N
	62298	300 X 109 X 39N	CT30N
	62299	300 X 109 X 39W	604.2
	62362	320 X 100 X 38	CT230
	62364	320 X 100 X 41	360, 604, R604
	62365	320 X 100 X 42	1204C, 1204LC, 130LC, CT250, CT300
62366	320 X 100 X 43	804, 804R	
62437	450 X 71 X 86	805R	
ATN	62234	230 X 48 X 64	PIAF 450, PIAF 560
	62236	230 X 48 X 68	PIAF 800
	28360	230 X 96 X 32	PIAF 450
AUSA	28341	180 X 60 X 30	25CM
	62214	180 X 72 X 38	MH08
	28355	230 X 72 X 48	80CMA
AVANT TECNO	28334	230 X 72 X 45	DUMPER 1200
	62266	250 X 72 X 45	DUMPER 1500
BARALDI	28335	180 X 72 X 34	MINIDIG
	28329	180 X 72 X 37	MINIDIG
	28326	230 X 72 X 43	102, 102B, EB40, FB 1.02, FB 1.2, FB102
	28334	230 X 72 X 45	FB203
BARATTI	28329	180 X 72 X 37	SKORPIO
BARETTA	28335	180 X 72 X 34	T21
	28326	230 X 72 X 43	T41, T43, T45
BASTEI	28329	180 X 72 X 37	SLD 151D
	62214	180 X 72 X 38	SLD151D
	62271	250 X 72 X 50	SLD251
BELLE	62226	200 X 72 X 37	5070
BENATI	28326	230 X 72 X 43	M13, M14
	62362	320 X 100 X 38	M22, M25
BENFRA	28326	230 X 72 X 43	9.01, 9.01B, 9.02S, 9:02
	84530	230 X 72 X 52	9.02B
BENNY	28326	230 X 72 X 43	SKORPIO 2C, SPIDER
BENTRAC	28334	230 X 72 X 45	M16
	62322	300 X 52,5 X 76N	M25
BERETTA	84522	200 X 72 X 36	T25
	62259	250 X 52,5 X 76N	T44
	62272	250 X 72 X 52	T45
	62322	300 X 52,5 X 76N	T46
BERTANI	28334	230 X 72 X 45	C-75
BERTOLINI	62207	180 X 60 X 38	BTR350, MINITRANSPORT
	28335	180 X 72 X 34	BTR500, BTR500D

Brand	Art./Ref.	Misura/Size	Applicazione/Application
BOBCAT	62214	180 X 72 X 38	316
	62215	180 X 72 X 39	E10, MT50, MT52
	62228	200 X 72 X 41	319
	28326	230 X 72 X 43	X119, X120, X122
	28331	230 X 96 X 33	322, 322G, 323, E322, X320 DELTA, X320E, X322, X322E
	62266	250 X 72 X 45	X220, X320, X322
	62268	250 X 72 X 47	X123
	62319	300 X 52,5 X 74N	X325, X328, X328E
	62328	300 X 52,5 X 80N	X231, X331, X331E, X334
	62360	300 X 55 X 88	335, 430ZTS
	84598	320 X 52,5 X 74N	325D, 328D
	84604	320 X 54 X 82	303CR
	84606	320 X 84 X 46B	T140FINOOTT05
	84607	320 X 86 X 46B	T140DAOTT05
	84608	320 X 86 X 49B	T180, T190
	62381	320 X 86 X 52B	864, T190, T200
	62362	320 X 100 X 38	X125
	62363	320x100x40.	X225
	62409	400 X 72,5 X 70W	X335
	62417	400 X 72,5 X 74KW	435ZTS, X337, X341
	62419	400 X 72,5 X 74W	435ZTS, X337, X341
	62420	400 X 72,5 X 76W	E60ZTS
	62434	450 X 71 X 80	X445
	62437	450 X 71 X 86	442ZTS, X442
62447	450 X 81 X 76W	E80ZTS	
62455	450 X 86 X 52B	864, T190, T200	
62456	450 X 86 X 55B	T250, T300, T320	
BONNE ESPERANCE	28332	230 X 72 X 41	MICROSAND
	62268	250 X 72 X 47	B23RP
	62272	250 X 72 X 52	BE2050, MINISAND
	62366	320 X 100 X 43	B35RP
BORMOR	62250	230 X 72 X 56	200TX, 400TX
BOXER	28344	180 X 72 X 36	TL224
BROKK	84522	200 X 72 X 36	100, 90, BM110, BM150, BM150C, BM150P
	28327	230 X 72 X 42	180
	62250	230 X 72 X 56	180
	62253	230 X 96 X 41	K330
	62277	250 X 96 X 41	K330
	62355	300 X 55 X 78	330
CAMECA	62226	200 X 72 X 37	BABY
CAMISA	61551	180 X 60 X 35	280, 380
	28335	180 X 72 X 34	580
	62207	180 X 60 X 38	480H
	62227	200 X 72 X 40	680
CANYCOM	28342	180 X 60 X 34	BFP401, BFP402, BFP405
	28343	180 X 60 X 37	BFP501, BFP602
	62210	180 X 72 X 31	BFP405, BFP411, BFP412, VFB405
	62276	250 X 72 X 57	1005
CARMIX	28326	230 X 72 X 43	K413, K414, K415
	62362	320 X 100 X 38	K425, K425.M
CARRIER	28341	180 X 60 X 30	HP250
	28342	180 X 60 X 34	HP250
	28343	180 X 60 X 37	HP250
	28346	200 X 72 X 34	HP400
	62226	200 X 72 X 37	HP500

Brand	Art./Ref.	Misura/Size	Applicazione/Application
<b>CARRIER</b>	<b>28340</b>	200 X 72 X 42	1200, 1700X
<b>CAT UK</b>	<b>28330</b>	230 X 96 X 31	301:05:00
	<b>28350</b>	230 X 96 X 34	301:08:00
<b>CATERPILLAR</b>	<b>62201</b>	150 X 72 X 33	ME05, MM05
	<b>28344</b>	180 X 72 X 36	ME08, ME08B, MM08B
	<b>62235</b>	230 X 48 X 66	189-0071
	<b>28334</b>	230 X 72 X 45	MS010
	<b>28330</b>	230 X 96 X 31	301.1, 301.5, 301.6, MM15T
	<b>28331</b>	230 X 96 X 33	301.6, 301.8, ME15, MH15, MM15
	<b>62251</b>	230 X 96 X 37	MX15
	<b>62266</b>	250 X 72 X 45	MS010
	<b>62317</b>	300 X 52,5 X 72W	MM25
	<b>62320</b>	300 X 52,5 X 74W	ME20, ME25, MM20, MM20CR, MM20SR, MM20T
	<b>62323</b>	300 X 52,5 X 76W	MM25, MM25T
	<b>62336</b>	300 X 52,5 X 84W	MM35, MM35B, MM35T, MM40SR, MX35
	<b>62343</b>	300 X 52,5 X 90W	303.5CCRV, 303CCR
	<b>62290</b>	300 X 109 X 36W	ME20, ME25
	<b>62299</b>	300 X 109 X 39W	ME30, ME35, MX35
	<b>84602</b>	320 X 54 X 76	302.5C
	<b>84604</b>	320 X 54 X 82	303.5
	<b>62362</b>	320 X 100 X 38	MS020
	<b>62363</b>	320x100x40.	MS020, MXR30, NS020
	<b>62366</b>	320 X 100 X 43	MS020, MS030, MS035, MS30SR, MX30SR, MX35R, MXR30, MXR35, MXR35SR, NS030, NS035
	<b>84616</b>	380 X 102 X 42	247, 247B, 257, 257B
	<b>62409</b>	400 X 72,5 X 70W	ME40, ME45, MX45
	<b>62413</b>	400 X 72,5 X 72W	304, 304.5, 304CR, 305, 305CR, MM40B, MM40CR, MM40T, MM45, MM45B, MM45T, MM55SR, MM57SR, MX45
<b>62420</b>	400 X 72,5 X 76W	305C, 305CCR	
<b>62430</b>	420 X 100 X 52	MS040	
<b>62431</b>	420 X 100 X 54	MX50, MX55, MXR50, MXR55	
<b>62435</b>	450 X 71 X 82	307A, 307B, 307C, 307SSR, E70, E70B	
<b>62438</b>	450 X 71 X 88	308	
<b>84650</b>	460 X 102 X 56	267, 267B, 277, 277B, 277C, 287	
<b>CELA</b>	<b>28326</b>	230 X 72 X 43	TE 28
	<b>62366</b>	320 X 100 X 43	26, 28
	<b>62373</b>	320 X 100 X 52	560
<b>CHIEFTAN</b>	<b>28329</b>	180 X 72 X 37	7FX, IS07FX
	<b>28326</b>	230 X 72 X 43	10, 10G, 10S, 12G
	<b>62367</b>	320 X 100 X 44	IS33F, IS33X
	<b>62369</b>	320 X 100 X 46	IS35F
<b>CHIKUSU</b>	<b>62205</b>	180 X 60 X 32	BFP301
	<b>28342</b>	180 X 60 X 34	BFP402, CC350
	<b>28343</b>	180 X 60 X 37	BFP602, CC450
	<b>62210</b>	180 X 72 X 31	BFP405
	<b>28335</b>	180 X 72 X 34	BFK 703, BFK 709, BFP 703, BFX 703, CC 500, CC 600, GC403/GG403
	<b>28346</b>	200 X 72 X 34	CANYCOM MINITRAC BFK709, CC500, CC600, D50, GC403
	<b>28351</b>	200 X 72 X 39	GC 41, GC 42
	<b>28340</b>	200 X 72 X 42	BFS 901Q, CC 700
	<b>28327</b>	230 X 72 X 42	BFK 808, BFS901Q, BFY 901, CC800 (VERSIONE 1)
	<b>28326</b>	230 X 72 X 43	403, CC300, CC800, GC403, GC50
	<b>62247</b>	230 X 72 X 44	BFG1003, BFG1005, CC800, DUMPER, GC100, GC640, GC640R, GCS40
	<b>28334</b>	230 X 72 X 45	CC800, GC640
	<b>28358</b>	230 X 72 X 47	BFG1005
	<b>84530</b>	230 X 72 X 52	BFG1005
	<b>62266</b>	250 X 72 X 45	CC800, GC640
	<b>84590</b>	280 X 72 X 48	BFG1301, BFG1302, BFG1303, CC1300, CC1550

Brand	Art./Ref.	Misura/Size	Applicazione/Application
CHIKUSUI	62385	320 X 90 X 58	525A, BFY3301, SE3801
CME	28327	230 X 72 X 42	M12
	28326	230 X 72 X 43	M12, M15
CASE NEW HOLLAND	62201	150 X 72 X 33	H05
	28344	180 X 72 X 36	CK08
	62216	180 X 72 X 40	E09SR
	62217	180 X 72 X 40KB	E09SR
	62232	230 X 48 X 60	CK13, CK15
	84526	230 X 48 X 70K	516, CX14, CX16B, CX16SVC, CX16SVR, CX18B, E16, E16 EVOLUTION, E17, E18, E18 EVOLUTION, EH15B, EH18, HNK16C, NHK16R, NHK18C, NHK18R
	62245	230 X 72 X 39	TF300, TF300RT
	62250	230 X 72 X 56	6010 TURBO
	28330	230 X 96 X 31	15 FERMEC, 15 MAXI FERMEC, 16RTN-MAXI FERMEC, 80T5, 80T7, CK16, CX15STR, CX16
	28331	230 X 96 X 33	EC15
	62256	250 X 52,5 X 72K	E20SR, E22SR
	62258	250 X 52,5 X 76K	CX25, E25SR
	62259	250 X 52,5 X 76N	CX20B, CX20BMR, CX22B, E20.2SR, E22.2SR, NHK20SR3R, NHK22SR3C
	84578	250 X 52,5 X 80N	CX27, CX27B, CX27BMC, E27.2SR, EH27B, NHK25SR3C, NHK25SR3R
	62316	300 X 52,5 X 72N	CK25, CK28
	62317	300 X 52,5 X 72W	23MAXI, CX23
	62322	300 X 52,5 X 76N	CX22BZTS
	62331	300 X 52,5 X 82N	EH30B, NHK30SR3C, NHK30SR3R
	62332	300 X 52,5 X 82W	31, 31 MAXI, CK31, E30.2SR, E30SR
	62336	300 X 52,5 X 84W	CK36
	62338	300 X 52,5 X 86W	35, CX35
	84595	300 X 52,5 X 88K	CX36, CX36B, CX36BMC, CX36BMR, E35.2SR, E35SR, EH35B, NHK35SR3C
	62352	300 X 55 X 72	EC25, EC25SR, EH20SR, EH25
	62354	300 X 55 X 76	EH25SR
	62355	300 X 55 X 78	CK32, EC35, EC35SR
	62296	300 X 109 X 38W	28, 28 MAXI, CK28, CX28
	62302	300 X 109 X 40W	31, 31MAXI, CK31, CX31
	62305	300 X 109 X 41W	CK36
	62308	300 X 109 X 42W	35
	62377	320 X 54 X 78	CK32
	84609	320 X 86 X 50B	420CT
	62396	350 X 56 X 84	CK38
	62387	350 X 108 X 42	35, 35MAXI, 35STB, CK35
	84615	350 X 108 X 44	EH35, EH35SR
	62412	400 X 72,5 X 72N	CX50
	62413	400 X 72,5 X 72W	CK50, EC45, EC45SR
	62417	400 X 72,5 X 74KW	6060 TURBO
	62419	400 X 72,5 X 74W	6060 TURBO
	62420	400 X 72,5 X 76W	EC60
	62423	400 X 74 X 68	CX40B, CX40BMC, CX40BMR, E40.2SR, E40SR, NH40SR3C
	62424	400 X 74 X 72	CX47, CX50B, CX50BMC, CX50BMR, E45.2SR, E45SR, E50.2SR, EH45, EH45SR, EH50B, NHK50SR3C
	62434	450 X 71 X 80	9007 ALLIANCE
62435	450 X 71 X 82	9700CK	
62439	450 X 73,5 X 80	9700	
62443	450 X 81 X 72W	CK62	
84632	450 X 81,5 X 76	E70SR, E80, E80MSR, EH70	
62456	450 X 86 X 55B	445CT, 450CT, LT185B, LT190B	
COMECA	28344	180 X 72 X 36	BAMBY B
COMET	28335	180 X 72 X 34	CH2, CH3
	28329	180 X 72 X 37	MT13, MT13AB
	28327	230 X 72 X 42	MT13BB
	28326	230 X 72 X 43	3.01

Brand	Art./Ref.	Misura/Size	Applicazione/Application
COMET/IMECA	28329	180 X 72 X 37	13AB
	28340	200 X 72 X 42	MT13BB
	28327	230 X 72 X 42	MT13BB
	28326	230 X 72 X 43	3:01
CONJET	28355	230 X 72 X 48	322
CORMIDI	28343	180 X 60 X 37	50, 6.5
	28335	180 X 72 X 34	10.65 CARRIER, 13.80B, 5.65, 6.65, 65, 9.65 CARRIER, C.20.150 CARRIER
	28329	180 X 72 X 37	14.9, 9.65R
	62215	180 X 72 X 39	14.65
	28355	230 X 72 X 48	20.150, 23.150, C20.150
	84612	320 X 86 X 48T	C145
DAEWOO	28344	180 X 72 X 36	SOLAR 007
	28329	180 X 72 X 37	SOLAR 010, SOLAR 10
	28331	230 X 96 X 33	SOLAR 015, SOLAR 15, SOLARIS
	84571	230 X 96 X 35	SOLAR015PLUS, SOLAR018, SOLAR018VT
	62319	300 X 52,5 X 74N	SOLAR 25
	62322	300 X 52,5 X 76N	SOLAR030, SOLAR030PLUS, SOLAR30, SOLARDH30
	62328	300 X 52,5 X 80N	SOLAR 35
	62335	300 X 52,5 X 84N	SL035, SOLAR 035, SOLAR035PLUS
	62336	300 X 52,5 X 84W	DH35
	62289	300 X 109 X 36N	SOLAR 25
	62298	300 X 109 X 39N	AH30, SOLAR35
	62366	320 X 100 X 43	DSL702, SOLAR DSL702
	62417	400 X 72,5 X 74KW	DH50, SOLAR 55, SOLAR 55 V, SOLAR 55V PLUS, SOLAR DH50
	62419	400 X 72,5 X 74W	DH50, SOLAR55, SOLAR55V, SOLAR55VPLUS, SOLARDH50
62420	400 X 72,5 X 76W	SOLAR55.3	
62445	450 X 81 X 74W	SOLAR70, SOLAR75V	
DITCH WITCH	84515	180 X 72 X 32	SK300, SK350
	62215	180 X 72 X 39	JT520, SK500
	62245	230 X 72 X 39	HT25, JT1200, JT2511
	62250	230 X 72 X 56	920, 920L, JT820, JT920
	84571	230 X 96 X 35	MX182
	84577	250 X 52,5 X 78N	MX202
	62266	250 X 72 X 45	XT850
	62275	250 X 72 X 56	JT3510
	84592	280 X 72 X 56	JT1220, JT1720
	84593	300 X 52,5 X 92N	JT2320, JT2520, JT2720
	62346	300 X 52,5 X 98N	JT2720ALL
	62422	400 X 72,5 X 82W	JT4020
62438	450 X 71 X 88	HT115, JT7020	
DOOSAN	62328	300 X 52,5 X 80N	DX27Z
	62335	300 X 52,5 X 84N	DX30Z
	62337	300 X 52,5 X 86N	DX35Z
	62420	400 X 72,5 X 76W	DX60R
	62447	450 X 81 X 76W	DX80R
DRAGO	28326	230 X 72 X 43	DRAGO SWISS
DYNAPAC	28334	230 X 72 X 45	D15, FC15, VD15
	28357	230 X 72 X 46	RT1000, RT80
	28331	230 X 96 X 33	VD151
	62266	250 X 72 X 45	D15, FC15, VC15, VD15
	62319	300 X 52,5 X 74N	VD251
	62289	300 X 109 X 36N	VD251
	62363	320x100x40.	VD25, X1
62366	320 X 100 X 43	CD35, VD30	
EAGLE TRAX	28363	230 X 96 X 39	TRAX 40

Brand	Art./Ref.	Misura/Size	Applicazione/Application
ECKART	28335	180 X 72 X 34	1 B30, EMB450B
ECOMAT	28326	230 X 72 X 43	650S, EB10, EB10.4, EB11, EB12, EB12.4, EB14, EB14.2, EB14.4, EB150XR, EB271, EC14, EC15BXR, SIRIUS
	28334	230 X 72 X 45	EB14, EB14.4, EB16.4
	28358	230 X 72 X 47	EB11, EB16, EB16.4, EB16.5
	28331	230 X 96 X 33	EB150, EB150XR, EB150XT, EB150XTV, EC13, EC15, EC15B, EC15XR
	62266	250 X 72 X 45	EB14, EB14.4, EB16.4
	62268	250 X 72 X 47	EB11, EB16, EB16.4, EB16.5
	84579	250 X 96 X 36	EB200, EB200XT, EB200XTV, EB263, EC20, EC20B, EC20BXTV
	62317	300 X 52,5 X 72W	EB22.4, EB25.4, EB28.4, EB30.4
	62336	300 X 52,5 X 84W	EB25.4, EB28, EB28.4, EB306, EB350, EB36, EB400, EB406, EC35, LS200, LS2000, LS286, LS386, LS406
	62287	300 X 109 X 35W	EB22.4, EB25.4, EB28.4, EB30.4
	62296	300 X 109 X 38W	EB250, EB300, EB350, EC25, EC30, EC300
	62305	300 X 109 X 41W	EB25.4, EB28, EB28.4, EB306, EB350, EB36, EB400, EB406, EC35, LS200, LS2000, LS286, LS386, LS406
	62362	320 X 100 X 38	EB22, EB27, Y22
	62366	320 X 100 X 43	EB36
	62406	400 X 72,5 X 68W	EB450, EC45
	62413	400 X 72,5 X 72W	EB506
	62417	400 X 72,5 X 74KW	EC55, EC55B
62419	400 X 72,5 X 74W	EC55, EC55B	
62434	450 X 71 X 80	EB706, EC70	
ELEKTRO JOE	28335	180 X 72 X 34	ECOJOLLY
EMCI	84523	200 X 72 X 38	SILEA
	62373	320 X 100 X 52	INOVA
ETEC	62362	320 X 100 X 38	25
EUROCAT	28326	230 X 72 X 43	140HVS, 140LSE, 150LSE
	62266	250 X 72 X 45	210HVS
	62271	250 X 72 X 50	200LSE, 210HVS, 210LSE, 250LSE
	62298	300 X 109 X 39N	350SLE
	62367	320 X 100 X 44	350SLE
EUROCOMACH	28335	180 X 72 X 34	E800, ES80, ES90
	28346	200 X 72 X 34	ES90
	62226	200 X 72 X 37	E1300, ES90
	62234	230 X 48 X 64	E1500S
	62239	230 X 48 X 74	ES250
	28326	230 X 72 X 43	E 1200, E 1500, E 1500SB, E1300, E1550S, ES150, ES150.2, ES180, ES180.2
	28360	230 X 96 X 32	E1500, E1500S, ES180.2
	28331	230 X 96 X 33	ES150, ES150.1, ES150.2, ES180
	84571	230 X 96 X 35	ES180SR, ESW180SR
	84575	230 X 101 X 31	E1500
	62319	300 X 52,5 X 74N	ES300
	62331	300 X 52,5 X 82N	ES350ZT
	62335	300 X 52,5 X 84N	ES400, ES400SR, ES400ZT
	62352	300 X 55 X 72	ES300
	62364	320 X 100 X 41	E2500
62413	400 X 72,5 X 72W	ES500, ES500ZT	
EURODIG	28342	180 X 60 X 34	DUMPY 300, DUMPY 800
	62208	180 X 60 X 40	DUMPY 500
	28335	180 X 72 X 34	800, DUMPY 500-2, G 500, GR 500, GR 700
	28329	180 X 72 X 37	DUMPY 800-2, MINIDIG1000, MINIDIG700
	62226	200 X 72 X 37	DUMPY 500, DUMPY 800P, GR1000, GR700A, GR700A3, GR700D, GR900, MINILOAD 800
	84530	230 X 72 X 52	MINILIFT C18
	62251	230 X 96 X 37	TS20
	62272	250 X 72 X 52	C15, C18, MINLIFT C18

Brand	Art./Ref.	Misura/Size	Applicazione/Application
EUROTOM	28331	230 X 96 X 33	TS15, TS15S, TS17SE
	62251	230 X 96 X 37	TS20
	62319	300 X 52,5 X 74N	TS27S
	62328	300 X 52,5 X 80N	TS30R
	62331	300 X 52,5 X 82N	TS35
	62352	300 X 55 X 72	TS25
	62355	300 X 55 X 78	ME1400H, NB30, TS30, TS30R, TS35, TS35S
	62409	400 X 72,5 X 70W	TS45
	62413	400 X 72,5 X 72W	TS45
62437	450 X 71 X 86	TS75, TS75S	
EUROTACH	28329	180 X 72 X 37	COMET MT13
	62234	230 X 48 X 64	T150
	28326	230 X 72 X 43	T4
	28334	230 X 72 X 45	T4ALT
	28360	230 X 96 X 32	T150
	28331	230 X 96 X 33	CHASSIS T150 A
	84571	230 X 96 X 35	T150A
	62290	300 X 109 X 36W	T300
	62299	300 X 109 X 39W	T300A
	62413	400 X 72,5 X 72W	T500
	62420	400 X 72,5 X 76W	T500A
FAI	28326	230 X 72 X 43	212
	28330	230 X 96 X 31	212, 215, 218
	84574	230 X 101 X 30	212, 215, 218
	62291	300 X 109 X 37K	220, 222, 225, 226
	62300	300 X 109 X 40K	232
	62303	300 X 109 X 41K	230, 235, 240
	62368	320 X 100 X 45	230ALT
	62402	400 X 142 X 37K	245, 250
FERCAD	28342	180 X 60 X 34	T3250
	84513	180 X 60 X 36	T6350
FERMEC	28330	230 X 96 X 31	MF 114, MF 115, SK015
	62332	300 X 52,5 X 82W	MF130, MF131, SK030
	62338	300 X 52,5 X 86W	135, SK035
	62296	300 X 109 X 38W	128, MF125, MF128, SK025
	62302	300 X 109 X 40W	MF130, MF131, SK030
	62308	300 X 109 X 42W	135
	62387	350 X 108 X 42	MF135, SK035
	62417	400 X 72,5 X 74KW	145, 150
	62419	400 X 72,5 X 74W	145, 150
FIAT HITACHI	28330	230 X 96 X 31	FH 15.2, FH 15.2 PLUS, FH15
	28331	230 X 96 X 33	FH 16.2, FH 17.2, FH 17.2 PLUS, FH16.2 PLUS, FH17.2B
	62257	250 X 52,5 X 73N	FH22, FH22.2
	62319	300 X 52,5 X 74N	FH22, FH22.2, FH22PLUS
	62331	300 X 52,5 X 82N	FH30.2, FH35.2
	62356	300 X 55 X 80	EX30U, EX33U, FH30.2PLUS, FH35.2, FH35.2PLUS, SH30.2
	62413	400 X 72,5 X 72W	FH40.2, FH40.2PLUS, FH45.2
FIORI	28346	200 X 72 X 34	MD07
FOREDIL	28334	230 X 72 X 45	FM16, FM18V, FM19RSV, FM19VR
	62352	300 X 55 X 72	FM24
	62355	300 X 55 X 78	FM29, FM34
	62413	400 X 72,5 X 72W	FM54
FORT	62207	180 X 60 X 38	MINIDUMPER
FRASTE	28335	180 X 72 X 34	TERRAIN
	28326	230 X 72 X 43	PL



Brand	Art./Ref.	Misura/Size	Applicazione/Application
FRASTE	28363	230 X 96 X 39	ML
	62272	250 X 72 X 52	ML
	62357	300 X 55 X 82	XL
FURUKAWA	28344	180 X 72 X 36	FX007, FX008
	28329	180 X 72 X 37	FX007, FX008, FX008.2
	62216	180 X 72 X 40	UX10
	28340	200 X 72 X 42	FX012
	62232	230 X 48 X 60	FX012, FX012.1, FX013.2, FX014, FX015.2
	28327	230 X 72 X 42	FX012, FX014
	28358	230 X 72 X 47	
	62336	300 X 52,5 X 84W	FX042UR, UX30, UX35
	62357	300 X 55 X 82	FX301UR
	62305	300 X 109 X 41W	FX042UR, UX30, UX35
	62413	400 X 72,5 X 72W	FX040, FX040.2, FX045, FX045.1, FX045.2, FX50URG, FX55UR, FX55UR.2, UX45
	62417	400 X 72,5 X 74KW	FX052UR, FX58MU
	62419	400 X 72,5 X 74W	FX052UR, FX58MU
	62420	400 X 72,5 X 76W	FX055, FX55
	62443	450 X 81 X 72W	FX60.2, FX60.3, FX60URG
62447	450 X 81 X 76W	FX75UR	
G&D ITALIA	28329	180 X 72 X 37	HCC1051D
GEHL	28327	230 X 72 X 42	GX10
	28365	230 X 96 X 36	153
	84580	250 X 96 X 38	193, 223
	62296	300 X 109 X 38W	303
	62299	300 X 109 X 39W	363
	84612	320 X 86 X 48T	CTL60
	84613	320 X 86 X 52T	4640, CTL60
	62367	320 X 100 X 44	GX30
	62413	400 X 72,5 X 72W	GX35
	62417	400 X 72,5 X 74KW	502
	62419	400 X 72,5 X 74W	502
	62436	450 X 71 X 84	802
	62432	450 X 100 X 50	CTL80
GEHLMAX	28344	180 X 72 X 36	M045, MB045
	62227	200 X 72 X 40	DR600
	62238	230 X 48 X 72	GE222
	28326	230 X 72 X 43	A12, A12B, A14SA, M135, M135S, MB138, MB148
	28334	230 X 72 X 45	M135, MB1135S, MB145, MB165
	84530	230 X 72 X 52	RD15D, RD15DR
	28365	230 X 96 X 36	GE222
	62266	250 X 72 X 45	M135, MB1135, MB1135S, MB145, MB165
	62325	300 X 52,5 X 78N	MB288
	62335	300 X 52,5 X 84N	MB358
	62305	300 X 109 X 41W	353, 373
	62377	320 X 54 X 78	GE342
	62362	320 X 100 X 38	A250SA
	62363	320x100x40.	MB135, MB135S, MB245
	62370	320 X 100 X 48	MB435, MB445
GEOTOOL	28343	180 X 60 X 37	GEOTOOL
GRILLO	28342	180 X 60 X 34	DUMPER 350
	28335	180 X 72 X 34	DUMPER 350HD, DUMPER 507
HANIX	62201	150 X 72 X 33	H05
	62214	180 X 72 X 38	H08B, N050, N080, N080.2LR
	62239	230 X 48 X 74	H22B
	28326	230 X 72 X 43	N 150, N 150 R, N120, N120R
	28334	230 X 72 X 45	N120R, N6, RK15

Brand	Art./Ref.	Misura/Size	Applicazione/Application
HANIX	28357	230 X 72 X 46	100B3, RT100, RT100B3, RT100D3, RT80
	62248	230 X 72 X 50	YFW5D.1
	28330	230 X 96 X 31	H12A, H15, H15A, H15B, H15B PLUS
	28331	230 X 96 X 33	150N, H15, H15.1, H15A, H15B PLUS.2, H15B.2, N120.2, N150.2, N150.2R
	62251	230 X 96 X 37	NS20, S&B150, S&B150.2
	62266	250 X 72 X 45	N06, N060, N120, N120R, N6, RK15
	62271	250 X 72 X 50	YFW5D.1
	62319	300 X 52,5 X 74N	H22A, H24, H27, N230.2, N230.2R, N250.2, N260.2, N26B, NS25
	62328	300 X 52,5 X 80N	N300.2, N300.2R, N350.2, S&B300, S&B300.2
	62335	300 X 52,5 X 84N	H36CR
	62352	300 X 55 X 72	H22, H24A, H25B, H26B, H27.2
	62355	300 X 55 X 78	H29A, H30, H30.2, H30A
	62357	300 X 55 X 82	H36B
	62289	300 X 109 X 36N	230.2, 230.2R, 250.2, 260.2, H24, H27, NS25
	62298	300 X 109 X 39N	H35, H35A, H36A, N300.2, N300.2R, N350.2, N350.2R, S&B300, S&B300.2
	62299	300 X 109 X 39W	N35
	62362	320 X 100 X 38	N219, N220, N220R, N220RC18, N250, N250R, N250RC18
	62363	320x100x40.	N15, N20, N220, N220R, N250, N250R, N300, N300R, N350R, S&B1, S&B12, S&B12R, S&B15R, S&B15S, S&B15SR, S&B20, S&B20S, S&B20SR, S&BX.1, S&B15RC, X1
	62366	320 X 100 X 43	N15, N20, N220R, N250, N250R, N300, N300R, N320, N350, N350.2, N350R, N350R2, N350RH, S&B1, S&B115, S&B15, S&B15R, S&B15RC, S&B15S, S&B15SR, S&B20, S&B20.5, S&B20R, S&B20S, S&B20SR, S&B220
	62409	400 X 72,5 X 70W	H45, H45A, N400.2, N450.2, N450.2R, S&B480
	62413	400 X 72,5 X 72W	H50B, H50C, H56C, N400.2, N450.2, N450.2R, S&B480
	62417	400 X 72,5 X 74RW	S&B25.1, S&B25.2
	62419	400 X 72,5 X 74W	S&B25.1, S&B25.2
62430	420 X 100 X 52	N450, N450R, N550.2	
62431	420 X 100 X 54	N550.2, S&B225, S&B25, S&B25R, S&B25S, S&B30, S&B30R, S&B30S, S&B330, S&B500, S&B550, S&B580	
62437	450 X 71 X 86	H75B, H75C	
62449	450 X 81 X 78W	S&B800, S&B800.2	
84640	450 X 90 X 58	RT400, RT400E1	
HANIX NISSAN	28344	180 X 72 X 36	H 08, H 08-2, N 80, N 80-2, N 80-2R, RT30, S&B08
	28329	180 X 72 X 37	H08.1, H08A, H80, H80.2, N 080, N 080-3LR, RT30
	28331	230 X 96 X 33	N 120-2, N 150-2, VD 151
HANTA	28329	180 X 72 X 37	SLD 51D
	62271	250 X 72 X 50	SLD251D
HAULOTTE	62276	250 X 72 X 57	PLATFORM
HCC	28343	180 X 60 X 37	1051D
	28329	180 X 72 X 37	1050, 1050B, 1051D
	62271	250 X 72 X 50	2051
HINOWA	62201	150 X 72 X 33	HS400
	28343	180 X 60 X 37	DUMPY
	28335	180 X 72 X 34	10.5, 1055, 12.5, 12.65, 14.65, DM 8, DM 8 A, DM 8 M, E 800, HP 1000, HP 800 MINIEXCAVATOR, HP 800A MINIDU, HP 800E MINIDU, PT8G, TERRAIN
	62212	180 X 72 X 35	HP850, HS850, PT9C
	28329	180 X 72 X 37	12.55, DB14.7, DB8.35, DM10, GL 1255, GL 1470, HP1000, HP1000E, HP1100, HP1100A, HP1150, HP1200, HP1200E, HP850B/A, HS1100, HS1150, HS1200, LL1470, PT9
	62215	180 X 72 X 39	DM10M
	62226	200 X 72 X 37	DB9.11, DM09, DM10A 2V, DM10AZV, PT10G
	28340	200 X 72 X 42	DM 10 A 2 V, DM 13
	62234	230 X 48 X 64	DM15
	62242	230 X 48 X 80	HP1500, PT200P
	28327	230 X 72 X 42	DM11KA, DM13, PT13G
	28326	230 X 72 X 43	C15, DM 15, DM15S, DM55, HP 1510 (MINIDUMPER), HR 15.1, PT 15 - UNDERCARRIAGE, PT15G, VT 1550 2 V, VT 1650 2 V, VT1550, VT1650
	84530	230 X 72 X 52	DM20S
	28360	230 X 96 X 32	DM 15, DM15M, PT 15G - UNDERCARRIAGE, VT 1550, VT 1650

Brand	Art./Ref.	Misura/Size	Applicazione/Application
HINOWA	28331	230 X 96 X 33	TT1350
	62252	230 X 96 X 38	HP1500/2
	28363	230 X 96 X 39	DM 20 S, HP15, HP1500, MPT20A, PT2000, PT20G, VT 2000
	28364	230 X 96 X 40	HP1500, PT 200 - UNDERCARRIAGE, PT200P
	84575	230 X 101 X 31	DM15, DM15M, PT15G, VT1550, VT1650
	62259	250 X 52,5 X 76N	HP2500
	62272	250 X 72 X 52	DM20, PT20, PT20G, PT20GL
	62276	250 X 72 X 57	PICCHIO 16.90, PT20G, PT20GL, TP1800
	62355	300 X 55 X 78	PT3000, PT3000GL, VT3000
	62357	300 X 55 X 82	DM30, DM30S, DM40, DM40L, DM40L2V, PT30G
	62366	320 X 100 X 43	PT35G
	62373	320 X 100 X 52	PT35GL
	62387	350 X 108 X 42	VT4000, VT4000.2V
	62388	350 X 109 X 41	PT4000
	62389	350 X 109 X 42	PT4000
	62413	400 X 72,5 X 72W	PT70GL
	62417	400 X 72,5 X 74KW	PT70, PT70G
	62419	400 X 72,5 X 74W	PT70, PT70G

HITACHI	28344	180 X 72 X 36	EX7
	28329	180 X 72 X 37	AX08, EG08, EX 7, EX 8, EX 8.1, EX 8.2, EX 8.2B, ZX8.2
	62213	180 X 72 X 37K	ZX8.2
	62216	180 X 72 X 40	EX10U, EX10UX
	84516	180 X 72 X 41K	ZAXIS 10U2
	28327	230 X 72 X 42	EX 14, EX12, EX14SR, HE 10, ME 15S, ME15S, UE 004, UE 10, UE 12, UE 15, UE 15 SR
	28326	230 X 72 X 43	UE15, UE15SR
	28357	230 X 72 X 46	CG8
	28330	230 X 96 X 31	EX 12, EX 15, EX 15-2, EX12.2, EX15.1, EX15U, EX16, SH 15-2
	28331	230 X 96 X 33	EX 17-2, EX15U, EX16, EX17, EX17.2B, HE 15, ME15, ZAXIS15, ZAXIS16, ZAXIS18, ZX16.3, ZX18, ZX18YLR
	84571	230 X 96 X 35	EX15UR, EX17U, ZX17, ZX17U.2
	62257	250 X 52,5 X 73N	EX18.2, EX20.2, EX22, EX22.1, EX22.2, ZAXIS 25, ZX25
	62259	250 X 52,5 X 76N	EX20U.3, EX20UR, EX20UR.1, EX20UR.3
	62260	250 X 52,5 X 77N	ZX22U.2
	84577	250 X 52,5 X 78N	EX20UR, EX20UR.2C
	62277	250 X 96 X 41	EX20U, EX20U.1
	62316	300 X 52,5 X 72N	EX21, EX24
	62322	300 X 52,5 X 76N	EX25, EX25.1, EX25.2, EX26, EX27, EX30UR
	62325	300 X 52,5 X 78N	EX27U, EX29U
	62328	300 X 52,5 X 80N	EX27.U2, ZX27U.2
	62331	300 X 52,5 X 82N	EX30U, EX30, EX30.1, EX30.2, EX30UR, EX30UR.3, EX32U, EX32UE, EX33MU, EX35.2, ZAXIS 30, ZAXIS 35, ZX30
	62335	300 X 52,5 X 84N	EX33, EX35.1, UE30
	62337	300 X 52,5 X 86N	EX35U, EX36U, EX40UR.3, UE35, ZAXIS 30U2, ZAXIS 35U3, ZX30U.2
	62353	300 X 55 X 74	EX30UR.1, EX30UR.2
	62357	300 X 55 X 82	EX35, EX40UR, EX40UR.1, EX40UR.2, EX40URG
	62286	300 X 109 X 35N	EX24, UE20
	62289	300 X 109 X 36N	FH22, FH22.2, FH22PLUS
	62292	300 X 109 X 37N	EX25, EX26, EX27
	62304	300 X 109 X 41N	EX33
	62362	320 X 100 X 38	HM20, UE20
	62363	320x100x40.	HM25, UE25
	62367	320 X 100 X 44	UE30
	62413	400 X 72,5 X 72W	EX40.1, EX40.2, EX40.2PLUS, EX40U, EX45.2, EX45U, EX50.1, EX50.2, EX50URG/3, EX55UR, UE40, UE45, UE50, ZAXIS40, ZAXIS50, ZX40, ZX50U, ZX55U
	62418	400 X 72,5 X 74N	ZAXIS 40U2, ZAXIS50U2
	62420	400 X 72,5 X 76W	EX55, EX55/1, EX55/2, EX55/3
	62443	450 X 81 X 72W	EX60.3/2, EX75UR/3
62444	450 X 81 X 74N	ZX70.4	
62447	450 X 81 X 76W	EX70UR, EX75UR.3/2, EX75UR/4, ZAXIS 85USBLC	

Brand	Art./Ref.	Misura/Size	Applicazione/Application
HITACHI	62448	450 X 81 X 78N	EX60LC.5
	84631	450 X 81,5 X 74	EX60.5, EX80, ZAXIS 70, ZAXIS805B, ZX70, ZX80
	84632	450 X 81,5 X 76	EX60LC.3/1, EX60URG.2/1, EX75UR.3/1
	84633	450 X 81,5 X 78	EX70U, EX75UR.5, EX75US.7, ZAXIS 70LC, ZAXIS 75US.3, ZX70LC, ZX75US3
HOKUETSU	28344	180 X 72 X 36	HM07S, HM07SG
	28331	230 X 96 X 33	HM10, HM15
	62362	320 X 100 X 38	HM20, HM20S, HM20SCG.2, HM20SG.2, HM20SMG.2, HM20SOG.2
	62363	320x100x40.	HM25
	62367	320 X 100 X 44	HM30, HM30SCG.2, HM30SG.2, HM30SMG.2, HM30SMG.3
HOLMAC	62226	200 X 72 X 37	HM200, HZC16, HZC22
	28326	230 X 72 X 43	HZC20, HZC26, HZC292X, R13700
HOLMED	84522	200 X 72 X 36	HOLMED
HONDA	28341	180 X 60 X 30	B114, HP250, HP300
	28342	180 X 60 X 34	HP250, HP350, SC 156 DD
	28343	180 X 60 X 37	B415, HP250, HP400 CARRIER, HP450, HP500 CARRIER
	28335	180 X 72 X 34	HP400, HP800A
	28346	200 X 72 X 34	HP400
	62199	200 x 72 x 35	SC433
	62226	200 X 72 X 37	HP500
HUKI	28335	180 X 72 X 34	GT33
	28346	200 X 72 X 34	50, 60, 60D, D50
	28327	230 X 72 X 42	80 B.4
	62247	230 X 72 X 44	100, 640R, DUMPER, GL640
	28355	230 X 72 X 48	100H-R, 130
HUTTER	28346	200 X 72 X 34	60H
	28327	230 X 72 X 42	80H
	28326	230 X 72 X 43	14G2
	28355	230 X 72 X 48	HR100
	62248	230 X 72 X 50	110H, 120H
	62276	250 X 72 X 57	HBR202TF
HYDRA	62207	180 X 60 X 38	9.2
	28326	230 X 72 X 43	JOY 1
	62272	250 X 72 X 52	JOY2
HYDRAMAC	28326	230 X 72 X 43	C4200, H 15
HYDRORAIN	62211	180 X 72 X 33	X400Y, X400YD, X500YD
	28357	230 X 72 X 46	X1000DH3
HYUNDAI	62239	230 X 48 X 74	ROBEX 22.7
	62319	300 X 52,5 X 74N	ROBEX28.5, ROBEX28.7
	62335	300 X 52,5 X 84N	ROBEX35.5
	62337	300 X 52,5 X 86N	ROBEX 35Z7
	62355	300 X 55 X 78	ROBEX 30
	62420	400 X 72,5 X 76W	ROBEX55.3, ROBEX55.7
	62437	450 X 71 X 86	ROBEX75.7
IBEA	62205	180 X 60 X 32	250
	28342	180 X 60 X 34	IBEA, IBT350
	28343	180 X 60 X 37	IBF 300, IBF 500D, IBF 500DH, IBT500
IHI	28343	180 X 60 X 37	CC450
	62210	180 X 72 X 31	316
	62211	180 X 72 X 33	4J, IS4F, IS4FG, IS4FX, IS4GX, IS4GX3, IS4J
	28335	180 X 72 X 34	10Z, 10S CARRY
	28329	180 X 72 X 37	102R, 103, 9NX, IS 7 F, IS 7 FX, IS 7 GX, IS 7 GX2, IS 7 GX3, IS 7 J, IS 7 P, IS07, IS07FP, IS07FX
	28346	200 X 72 X 34	CC600
	62228	200 X 72 X 41	IS9UX
	62234	230 X 48 X 64	15, 15J, 16N, 17J, 17JE, 17NE, IS15J, IS16N, IS17J, IS17JE

Brand	Art./Ref.	Misura/Size	Applicazione/Application
IHI	62242	230 X 48 X 80	20JX, 20NX, 20Z, IS18UJ, IS20JX
	28332	230 X 72 X 41	
	28327	230 X 72 X 42	CC800
	28326	230 X 72 X 43	IS 10 C, IS 10 F, IS 10 FX, IS 10 G, IS 10 GX, IS 10 S, IS 12 C, IS 12 G, IS 12 GX, IS 14 G, IS 14 GX, IS 14 PX, IS11X, IS12, IS12S, IS14, IS14.3, IS14GX2, IS14GX3
	28358	230 X 72 X 47	10 Z, 12 JX, 12J, 9JX, IS 9 UX-2, IS10Z, IS12JX, IS12NX, IS9UX3
	84528	230 X 72 X 47Y	12JX, IS12JX
	84530	230 X 72 X 52	MC15
	28360	230 X 96 X 32	15, 16N, 17NE, IMER 15 J, IMER 17 J, IMER 17 JE, IS15J, IS16N, IS17J, IS17JE
	84571	230 X 96 X 35	15NX, 17VXE, 18J, 18N, 18NXT, IS16J, IS18J
	28364	230 X 96 X 40	
	62268	250 X 72 X 47	IS10Z, IS12NX
	84581	250 X 96 X 40	20JX, 20NX, 20Z, IS18UJ, IS20JX
	84590	280 X 72 X 48	CC1500
	62317	300 X 52,5 X 72W	25J, IS25G, IS25GX, IS25J
	62323	300 X 52,5 X 76W	25JX, 28J, IS25JX, IS25NX, IS27, IS27G, IS27GX, IS28, IS28G, IS28G3, IS28GX, IS28J, IS28JX, IS28LX, IS28PX
	62325	300 X 52,5 X 78N	25NX.2
	62336	300 X 52,5 X 84W	30JX, 30NX, 35J, 35N, GX35, IS30JX, IS30NX, IS32J, IS35G, IS35G.1, IS35G.2, IS35GX, IS35GX.1, IS35GX.3, IS35J
	62343	300 X 52,5 X 90W	35FX, 35JX, 35N, 35NX, 35UJ, 40Z, CCH30T, IS35JX, IS35NX, IS35UJ, IS38UJ, IS40Z
	62287	300 X 109 X 35W	IS25GX, IS25J
	62293	300 X 109 X 37W	IS25JX, IS27, IS27G, IS27GX, IS28, IS28G, IS28GX, IS28J, IS28JX, IS28LX, IS28PX
	62299	300 X 109 X 39W	22UX, 28UX, 30S, IS28UX, IS28UX.2, IS30G, IS30GX, IS30GX.2, IS30J, IS30UJ, IS30UJ.2, IS30Z, IS38UX
	62305	300 X 109 X 41W	IS32J, IS35G, IS35G.1, IS35G.2, IS35GX, IS35GX.1, IS35GX.2, IS35GX.3, IS35J
	62385	320 X 90 X 58	IC30
	62362	320 X 100 X 38	IS25S, IS25S.2
	62363	320x100x40.	IS27F, IS27FX, IS27R
	62367	320 X 100 X 44	IS30F, IS30FX
	62369	320 X 100 X 46	IS33SX, IS35F, IS35FX, S33FX
	62387	350 X 108 X 42	T840
	62409	400 X 72,5 X 70W	IS40G, IS40GX, IS40GX.2, IS40J
	62412	400 X 72,5 X 72N	45J, 45J.2, 45NX.2, 45UJ, IS45J
62413	400 X 72,5 X 72W	40NX, 50NX, IS40JX, IS40NX, IS45J.2, IS45N, IS45NX, IS45UJ, IS55U.1, IS55U.2	
62417	400 X 72,5 X 74KW	55J, 55J2, 55N, 55UX, IS50G, IS50G3, IS50GX, IS50UJ, IS50UX, IS50Z, IS55G, IS55G.3, IS55J, IS55J.2, IS55LX, IS55N, IS55UJ, IS55UX	
62419	400 X 72,5 X 74W	50UX, 55J, 55J2, 55N, IS50G, IS50G3, IS50GX, IS50UJ, IS50UX, IS50Z, IS55G, IS55G.3, IS55J, IS55J.2, IS55LX, IS55N, IS55UJ, IS55UX	
62422	400 X 72,5 X 82W	65NX	
62435	450 X 71 X 82	65UJ, 70Z, 75NX, 75UJ, 80NX, IS65UJ, IS70Z, IS75UJ, IS80, IS80NX	
62439	450 X 73,5 X 80	70J	
62440	450 X 73,5 X 86	75UJ	
IMECA	28329	180 X 72 X 37	CHASSIS M13
IMEF	28335	180 X 72 X 34	HT 6.01
	28326	230 X 72 X 43	HE1.15, HE12, HE14, HE14S, HE16, HE16S
	28355	230 X 72 X 48	1.18, HE18, HE18S, HE18S
	62251	230 X 96 X 37	HE2.22
	62362	320 X 100 X 38	HE24
	62366	320 X 100 X 43	HE2.30, HE230, HE38
	84615	350 X 108 X 44	HE230
IMER	62210	180 X 72 X 31	316
	28335	180 X 72 X 34	105 CARRY
	28329	180 X 72 X 37	103, 9NX.3, IS 7 GX, IS 7 J
	62226	200 X 72 X 37	107 CARRY
	62234	230 X 48 X 64	15J, 16N, 17J, 17JE, 17NE
	62242	230 X 48 X 80	20JX, 20NX, 20Z
	28358	230 X 72 X 47	10Z, 12J, 12JX, 9JX
	84528	230 X 72 X 47Y	12J, 12JX

Brand	Art./Ref.	Misura/Size	Applicazione/Application
IMER	28355	230 X 72 X 48	CC100, CC1000
	28360	230 X 96 X 32	14NXT, 15J, 15NXT, 16N, 16NX, 17J, 17JE, 17NE
	84571	230 X 96 X 35	15NX, 16NXT, 17NXT, 17VXE, 18, 18J, 18N, 18NXT
	62268	250 X 72 X 47	10Z, 9JX
	84581	250 X 96 X 40	20JX, 20NX, 20Z
	62317	300 X 52,5 X 72W	25J
	62323	300 X 52,5 X 76W	25JX, 28J
	62325	300 X 52,5 X 78N	25NX.2
	62336	300 X 52,5 X 84W	30JX, 30NX, 30NX.2, 30VX.3, 35J, 35N.3
	62343	300 X 52,5 X 90W	35FX, 35JX, 35NX, 35UJ, 40Z
	62299	300 X 109 X 39W	22UX, 28UX
	84613	320 X 86 X 52T	CL35
	62409	400 X 72,5 X 70W	40J
	62412	400 X 72,5 X 72N	45NX.2
	62413	400 X 72,5 X 72W	40NX, 45J.2, 45N, 45UJ
	62417	400 X 72,5 X 74KW	50VX, 50Z, 55J, 55N, 55UJ
	62419	400 X 72,5 X 74W	50VX, 50Z, 55J, 55N, 55UJ
	62422	400 X 72,5 X 82W	65VX
62435	450 X 71 X 82	65UJ, 70Z, 75NX, 75UJ, 80NX, 80VX	
62440	450 X 73,5 X 86	75UJ	
ISEKI	84512	180 X 60 X 33	XL260, XL360
	62211	180 X 72 X 33	XL400
	28351	200 X 72 X 39	XC450
ITALMEC	62276	250 X 72 X 57	PLATFORM
IWAFUJI	62211	180 X 72 X 33	450
	28335	180 X 72 X 34	CT045
	28329	180 X 72 X 37	CT7NX, IS 07
	28346	200 X 72 X 34	CT045
	62228	200 X 72 X 41	CT100, CT100R, CT200R
	28332	230 X 72 X 41	CT 150 R
	28327	230 X 72 X 42	CT 120
	28326	230 X 72 X 43	CT 10, CT 12, CT10N, CT12N
	62320	300 X 52,5 X 74W	CT27N
	62336	300 X 52,5 X 84W	CT35N
	62362	320 X 100 X 38	CT230
	62363	320x100x40.	IS27F
	62365	320 X 100 X 42	CT250
	62409	400 X 72,5 X 70W	CT40N
	62417	400 X 72,5 X 74KW	CT50N
62419	400 X 72,5 X 74W	CT50N	
JCB	62212	180 X 72 X 35	MICRO
	28329	180 X 72 X 37	MICRO, MTL200, TD10, TD10SL
	28327	230 X 72 X 42	801, 801 R, 801FDI
	28326	230 X 72 X 43	801, 801R
	28330	230 X 96 X 31	801, 801 R, 801.4, 801.5, 801.6, 801.7, 801.8, 8012, 8014, 8015, 8015.2, 8016, 8017, 8018, 8018 TG
	28331	230 X 96 X 33	8016, 8018, 8018X
	84580	250 X 96 X 38	8020
	84583	250 X 109 X 36	802, 802 PLUS, 802 SUPER, 802.4
	84585	250 X 109 X 38	8025ZTS
	84586	250 X 109 X 41	8027Z, 8030ZTS
	62320	300 X 52,5 X 74W	802.8
	62336	300 X 52,5 X 84W	803, 803 MAGNUM, 803 PLUS, 803 SUPER, 803ZZ, 803E, 830
	62290	300 X 109 X 36W	802.7, 802.7PLUS
	62305	300 X 109 X 41W	803, 803 PLUS, 803ZZ, 803ZTS, 8035Z, 8035ZTS, 803E, 803MAGNUM, 803SUPER, 830
	84609	320 X 86 X 50B	ROBOT 180HF
	62381	320 X 86 X 52B	ROBOT 190 T

Brand	Art./Ref.	Misura/Size	Applicazione/Application
JCB	62365	320 X 100 X 42	803ALT
	62366	320 X 100 X 43	803.2
	62368	320 X 100 X 45	803.3
	62386	350 X 108 X 41W	804, 804PLUS
	62417	400 X 72,5 X 74KW	805, 805.2, 8052, 8055RTS, 8060
	62418	400 X 72,5 X 74N	8045ZTS
	62419	400 X 72,5 X 74W	805, 805.2, 8052, 8055RTS, 8060
	62439	450 X 73,5 X 80	J570
	84632	450 X 81,5 X 76	8080ZTS, JZ70
62455	450 X 86 X 52B	ROBOT110, ROBOT190T	
JOHN DEERE	28326	230 X 72 X 43	15
	62366	320 X 100 X 43	25, 30
	62413	400 X 72,5 X 72W	50ZTS
	62445	450 X 81 X 74W	80
KAIDI	28326	230 X 72 X 43	103, 103.3, WY 1.5
KATO	62413	400 X 72,5 X 72W	HD140
	62417	400 X 72,5 X 74KW	HD140, HD205UR, HD50UR, HD55UR
	62419	400 X 72,5 X 74W	HD140, HD205UR, HD50UR, HD55UR
	62436	450 X 71 X 84	70, HD307
KAWASAKI	62199	200 x 72 x 35	MINICARRIER
	84631	450 X 81,5 X 74	KE60
KOBELCO	28344	180 X 72 X 36	SK005
	28329	180 X 72 X 37	SK 002, SK 007, SK 007.1, SK 007.2, SK 007.3, SK 009, Z11 (CRAWLER CRANE)
	62214	180 X 72 X 38	FC50
	62216	180 X 72 X 40	SK09SR
	62217	180 X 72 X 40KB	SK09SR
	84526	230 X 48 X 70K	13SR, SK13SR, SK15MSR, SK16MSR, SK17
	62238	230 X 48 X 72	SK015R, SK15SR, SK15SR.1, SK20MSR
	28326	230 X 72 X 43	SK 014
	28330	230 X 96 X 31	115, SK 013, SK 015, SK013.1, SK014, SK014.1, SK015.1, SK15
	28365	230 X 96 X 36	SK 15 SR, SK15SR, SK15SR.1
	62256	250 X 52,5 X 72K	SK20SR.2
	62258	250 X 52,5 X 76K	25SR2, SK25SR.2
	62259	250 X 52,5 X 76N	20SR
	62262	250 X 52,5 X 80K	25SR, SK27SR.3
	84579	250 X 96 X 36	SK015R, SK20MSR
	84580	250 X 96 X 38	SK020SR, SK20SR
	62278	260 X 109 X 35	SK020
	62332	300 X 52,5 X 82W	SK024, SK027, SK027.1, SK030, SK030.1, SK030.2, SK030SR, SK030UR, SK030UR.1, SK030UR.2, SK27, SK30SR, SK30SR.1, SK30SR.2, SK30UR, SK30UR.1, SK30UR.2, Z14
	62338	300 X 52,5 X 86W	SK035, SK035COUPE
	84595	300 X 52,5 X 88K	SK35SR, SK35SR.3
	62387	350 X 108 X 42	SK035, SK035 COUPE, SK035.1, SK035.2
	84615	350 X 108 X 44	SK035SR, SK035SR.2, SK35SR.3
	62388	350 X 109 X 41	SK032, Z15
	62423	400 X 74 X 68	SK40SR, SK40SR.ZT, SK40SR3
	62424	400 X 74 X 72	B69, SH045.2, SK042, SK042.1, SK045, SK045.1, SK045KOUPE, SK050.1, SK45, SK45.1, SK45SR, SK45SR.2, SK45SR.ZT, SK45SR3, SK50, SK50.1, SK50UR, SK50UR.1, SK50UR.2
	84631	450 X 81,5 X 74	SK60, SK60 UR, SK60.1, SK60.2, SK60.3, SK60ZT, SK75UR, SK75UR.1, SK75UR.2
	84632	450 X 81,5 X 76	SK70SR, SK70SR.2, SK75UR.3, SK80, SK80MSR
84633	450 X 81,5 X 78	SK95	
KOMATSU	62201	150 X 72 X 33	PC02, PC02.1A, PC02.A
	62212	180 X 72 X 35	PC09
	28329	180 X 72 X 37	PC 03.1, PC 03.2, PC 03.2AVANCE, PC09UTILITY
	62227	200 X 72 X 40	PC08, PC08U, PC08UU, PC08UU.1, PC09FR
	62228	200 X 72 X 41	PC10MR, PC10MR1, PC10UU, PC10UU.3, PC15MR
	28327	230 X 72 X 42	PC 05-1, PC 05-5, PC05, PC05.2, PC05.6

Brand	Art./Ref.	Misura/Size	Applicazione/Application
KOMATSU	28326	230 X 72 X 43	PC09FR.1
	28358	230 X 72 X 47	PC07.7FR.1, PC15FR.1
	84528	230 X 72 X 47Y	PC07.7FR.1, PC15FR.1
	28330	230 X 96 X 31	PC 05-6, PC 05-7, PC 07, PC 07-6, PC 07-7, PC 15R, PC.07 AVANCE R, PC05, PC05 AVANCE R, PC05R, PC07.1, PC07.2, PC07.7, PC07R, PC12.8R AVANCE R, PC12R UTILITY, PC12R.8, PC12R.8 MISTRAL HS, PC14, PC14R.2, PC15.R AVANCE, PC15R MISTRAL, PC15R.8, PC15RHS, PC16, PC16MR2, PC16R, PC16R2
	84571	230 X 96 X 35	PC14HS, PC14R.2, PC15MR, PC15MR1, PC16HS, PC16R2, PC18, PC18MR2, U15
	84574	230 X 101 X 30	PC05, PC05.6, PC05.7, PC05AVANCE R, PC05R, PC07, PC07.1, PC07.2, PC07.6, PC07.7, PC07.7 AVANCE R, PC07R, PC12 RUTILITY, PC12R.8, PC12R.8 AVANCE R, PC12R.8 MISTRAL HS, PC15R, PC15R MISTRAL, PC15R.8, PC15R.8 AVANCE, PC15RHS
	62258	250 X 52,5 X 76K	PC10.6, PC10.7, PC10R, PC12, PC12 AVANCE R, PC12.1, PC12.2, PC12.2R, PC12R, PC12R.7UU, PC12UU, PC12UU.1, PC20.8, PC20R, PC20R.8
	62259	250 X 52,5 X 76N	PC10R.8, PC12R, PC12R8 ADVANCE, PC12UU, PC12UU.1, PC12UU.2, PC20.8, PC20MR.1, PC20R.8, PC20UU3
	84577	250 X 52,5 X 78N	PC20MR, PC20MR.1, PC20MR.2, PC20MRX, PC20MRX UTILITY, PC20UU, PC20UU3 ADVANCE
	62262	250 X 52,5 X 80K	PC15R, PC20.7, PC25R.8, PC28.1, PC28UU.3
	84578	250 X 52,5 X 80N	PC15.2, PC15.6, PC28UU
	84589	260 X 109 X 37	PC10, PC10 AVANCE R, PC10.5, PC10.6, PC10.7, PC10R.8, PC12UU.2
	62324	300 X 52,5 X 78K	PC15.7
	62325	300 X 52,5 X 78N	PC15.7
	62327	300 X 52,5 X 80K	PC28UU.2
	62328	300 X 52,5 X 80N	PC15.5, PC15R, PC15V, PC20, PC20 AVANCE R, PC20.6, PC20.7, PC20R, PC25R, PC25R.8, PC27, PC27MR, PC27MR2, PC27MRX, PC27R.8, PC28, PC28 AVANCE R, PC28.1, PC28.2, PC28R, PC28UU, PC28UU.1, PC28UU.2, PC28UU.3
	62334	300 X 52,5 X 84K	PC25.2, PC25.7
	62335	300 X 52,5 X 84N	PC20, PC20.2, PC20.6, PC25, PC25.1, PC25.2, PC25AVANCER, PC25R, PC30.6, PC30.7, PC30.7E, PC30AVANCER, PC30MR, PC30MRX, PC30R, PC30R.8, PC30UU.3, PC35MR, PC35MR.1, PC35MRX, PC35R.8, PC38.2, PC38.2AVANCER, PC38UU.2, PC38UU.3, PC38U-UM.2
	62337	300 X 52,5 X 86N	PC30MR2, PC30MR3, PC30MRX, PC35MR.2
	62355	300 X 55 X 78	PC15, PC15 AVANCE R, PC20.8, PC20R UTILITY, PC25R.8, PC27R UTILITY, PC28R.8
	62357	300 X 55 X 82	PC25.7, PC35R, PC35RUTILITY
	62350	300 X 55,5 X 82Y	PC30FR.2
	62291	300 X 109 X 37K	PC20UU3
	62303	300 X 109 X 41K	PC20, PC20.2, PC20.6, PC25, PC25.1, PC25AVANCE R, PC25R, PC30, PC30 AVANCE R, PC30.6, PC30.7, PC30.7E, PC30R, PC30R.8, PC30UU.3, PC35, PC35R, PC35R.8, PC38, PC38.2, PC38.2 AVANCE R, PC38UU.2, PC38UU.3, PC38UUM.2
	62381	320 X 86 X 52B	CK20, CK25.1
	84610	320 X 86 X 56B	CK30.1, CK35.1
	62385	320 X 90 X 58	CD23
	62363	320x100x40.	PC10
	62366	320 X 100 X 43	PC15.1
	62368	320 X 100 X 45	PC20, PC20.5, PC30, PC30.5
	62374	320 X 106 X 39Y	PC30FR
	62408	400 X 72,5 X 70N	PC38, PC38.1, PC38UU, PC38UU.1, PC38UU.2, PC40, PC40.1, PC40.5, PC40.6, PC50, PC50.1, PC50UU, PC50UU.1
62412	400 X 72,5 X 72N	PC40.7, PC40AVANCER, PC40MR, PC40MR.1, PC40MRX, PC40R, PC40R.8, PC45, PC45.1, PC45.1E, PC45.7, PC45AVANCER, PC45MR.1, PC45MR.2, PC45MRX, PC45R, PC45R UTILITY, PC45R.8, PC50.2, PC50.2 AVANCE R, PC50.3, PC50FR.1, PC50FR.2, PC50M.2, PC50UU.2, PC50UU.2E, PC50UU.3, PC50UUM.2, PC58	
62418	400 X 72,5 X 74N	PC40MR.2, PC50FR.2, PC50MR, PC50MR.1, PC50MR.2	
62401	400 X 142 X 36K	PC38, PC38.1, PC38UU, PC38UU.1, PC38UU.2, PC40, PC40.1, PC40.5, PC40.6, PC50, PC50.1, PC50UU, PC50UU.1	
62402	400 X 142 X 37K	PC40.7, PC40R, PC45, PC45.1, PC45.7, PC50.2, PC50.2 AVANCE R, PC50UU.2, PC50UU.2E	
62441	450 X 76 X 80	PC75, PC75.1, PC75R, PC75R.2, PC75R.8	
84627	450 X 76 X 84	PC95	
62450	450 X 83,5 X 72	PC60.6, PC60.7, PC60.8, PC70.7	
62451	450 X 83,5 X 74	PC60.6, PC70FR.1, PC75.1, PC75.2, PC75.6, PC75MR6, PC75UU, PC75UU.1, PC75UU.2, PC75UU.3, PC78MR6, PC78US.5, PC78US.6, PC78UU.6, PC88MR6	
84636	450 X 86 X 56B	1020 TURBO, CK1122.5, CK30, CK30.1, CK35.1	
84647	450 X 163 X 36	PC70.6, PC70.7	



Brand	Art./Ref.	Misura/Size	Applicazione/Application
KOMATSU	62433	450 X 163 X 37	PC60.7, PC70FR.1
	84648	450 X 163 X 38	PC60, PC60.5, PC60.6, PC60.7, PC70, PC75, PC75.1, PC75.2, PC75.6, PC75U.1, PC75UU, PC75UU.1, PC75UU.2
KUBOTA	62201	150 X 72 X 33	K005, KH005
	28342	180 X 60 X 34	KC40
	28344	180 X 72 X 36	CK 08, FH007, K007, KH 21, KH007, KX007
	28329	180 X 72 X 37	K 008, K 008.2, K 008.3, K 008DH, KH 007, KH 008, KH 07, KX 008, KXB 300, U008, U008.3
	62213	180 X 72 X 37K	K008.3, U008.3
	62215	180 X 72 X 39	KX21
	62216	180 X 72 X 40	U10, U10.3
	62217	180 X 72 X 40KB	U10.3
	28346	200 X 72 X 34	KC 50
	62199	200 x 72 x 35	RY600
	28351	200 X 72 X 39	KC50.1, KC50L, KC50LZ, KC51
	62232	230 X 48 X 60	K013, K015, KH012, KH41, KN36, KX012, KX014, KX041, KX36, KX36.2, KX41, KX41.2, KX41
	62234	230 X 48 X 64	KX36.3, KX41.2S, KX41.2SC, KX41.3SGL
	84526	230 X 48 X 70K	U17.3
	28327	230 X 72 X 42	HG, KH 012 VECCHIO TIPO, KH 012G, KH 012GH, KH 014, KH 014G, KH 014HG, KH 05, KH 12, KH 28, KH 31, KH 35, KH 36, KH 37, KH 41, KH 5, KH041, KH120, KH14, KH14G, KH14HG, KH38, KH50, KH55, KH55G, KH55GSRX, KH55R, KH55X, KM41
	28326	230 X 72 X 43	KH41
	28334	230 X 72 X 45	KC120, KC140
	28357	230 X 72 X 46	KC120, KC50, KC80D
	28355	230 X 72 X 48	KC110
	84529	230 X 72 X 49	KC100
	62248	230 X 72 X 50	KC100H
	84530	230 X 72 X 52	KC121
	28360	230 X 96 X 32	KX36.3, KX41.2SC, KX41.3SGL
	84571	230 X 96 X 35	KX41.2VC, KX41.3V, U15, U15.3
	62254	250 X 47 X 84	U20.3, U20.3V
	62259	250 X 52,5 X 76N	K022, KX61.2
	62266	250 X 72 X 45	KC120, KC140
	62271	250 X 72 X 50	KC100H
	62272	250 X 72 X 52	KC121
	62277	250 X 96 X 41	KX202, U20
	62316	300 X 52,5 X 72N	KH021, KH021HG, KH024, KH026, KH50, KH51, KH52, KH55, KH60, KH66, KH71, KN51, KX021, KX024, KX026, KX51, KX61
	62317	300 X 52,5 X 72W	KH026G, KH61
	62322	300 X 52,5 X 76N	K020, K022, K025, KH27, KH60, KH65, KH66, KH71, KX021, KX021UR, KX027, RX0201
	62323	300 X 52,5 X 76W	KH02, KH026HG, KH02G, KH02HG, KH060, KH071, KH24, KH24HG, KH26HG, KX02, KX60
	62328	300 X 52,5 X 80N	K028, K030, KX021UR, KX71.2
	62335	300 X 52,5 X 84N	KX035
	62336	300 X 52,5 X 84W	K035, KH033, KH033HG, KH040, KH101, KH90, KX033, KX101, KX90, RX301, RX301UR, RX302, RX303, SK031, U30, U30.1, U30.2, U30HG, U35, U35HG, UX30
	62347	300 X 53 X 80	K030.3, KX030.3, KX61.3, KX71.3, KX91.3, U25.3, U25.3G
	62348	300 X 53 X 84	K035.3, KX101.3, U30.3, U35.3
	62355	300 X 55 X 78	KX91.2S
	62286	300 X 109 X 35N	KH021, KH021HG, KH024, KH026, KH50, KH51, KH52, KH55, KH60, KH66, KH71, KN51, KX021, KX071
	62287	300 X 109 X 35W	KH026G, KH61
	62292	300 X 109 X 37N	K025, KH60, KH65, KH66, KH71
	62293	300 X 109 X 37W	KH02, KH026HG, KH02G, KH02HG, KH060, KH071, KH24, KH24HG, KH26HG
	62299	300 X 109 X 39W	KH030, KH030G, KH030HG, KH033, KH033HG, KH91, KX030, KX033, R30P
	62304	300 X 109 X 41N	KX035
	62305	300 X 109 X 41W	K035, KH033, KH033HG, KH040, KH101, KH90, KX033, KX101, KX90, RX302, RX303, U30, U30.1, U30.2, U30HG, U35HG, UX30
62384	320 X 90 X 56	RG30	
62385	320 X 90 X 58	KC250HR	
62363	320x100x40.	KH26SR, KH30SR, KH30SRG	

Brand	Art./Ref.	Misura/Size	Applicazione/Application
KUBOTA	62366	320 X 100 X 43	KH26SR, KH30SR, KH30SRG
	62395	350 X 54,5 X 86	KX121.3
	62396	350 X 56 X 84	K038, KX038, KX121.2, KX121.2S
	62409	400 X 72,5 X 70W	KX130
	62413	400 X 72,5 X 72W	K040, K045, K151, KH040, KH045, KH130, KH151, KX040, KX045, KX151, KX151.2, KX161.2, KX161.2SR, U45, U45G
	62415	400 X 72,5 X 74K	KX161.3, U45.3, U50.3
	62417	400 X 72,5 X 74KW	KX161.3, RX501, RX502, RX502VA, U45.3, U50.3
	62419	400 X 72,5 X 74W	KX161.3, RX501, RX502, RX502VA, U45.3, U50.3
	62420	400 X 72,5 X 76W	KH055, KH055N
	84625	400 X 144 X 38	RX501
	62430	420 X 100 X 52	KH50SR, KH51SR, KH52SR
	62431	420 X 100 X 54	K50SR, KH50SR, KH51SR, KH52SR
	62443	450 X 81 X 72W	KH191, KX191, KX60.2, KX60.3
	62445	450 X 81 X 74W	KX60.5, KX75UR.3
62447	450 X 81 X 76W	KX75UR, KX75UR.3	
84632	450 X 81,5 X 76	KX080.3	
LEO	28326	230 X 72 X 43	12G, 16GT, 16H, 16T, 22T, 23, 23H, 23T, 25, 25T
	84530	230 X 72 X 52	26
	62276	250 X 72 X 57	26T, 30, 301, 36, 36T
LIBRA	28342	180 X 60 X 34	T035
	28335	180 X 72 X 34	DUMPY, T 060 (CARRIER), T 090 (CARRIER)
	28344	180 X 72 X 36	104TL
	62227	200 X 72 X 40	T071, TP070
	62247	230 X 72 X 44	T100
	28334	230 X 72 X 45	104TL, 114, 114 S, 115 T, 116 S, 118, 118 S, 118 SV, 118SB, 120, 214S, 216 S, 218 SV, 218S, 219RSV, 220 R
	28331	230 X 96 X 33	106T2, 106TL
	62266	250 X 72 X 45	104TL, 114, 114S, 115T, 116S, 118, 118S, 118SB, 118SV, 120
	62319	300 X 52,5 X 74N	125S, 212T2, 225S
	62328	300 X 52,5 X 80N	130S, 135S, 230S, 235S
	62355	300 X 55 X 78	229S, 234S, CZ30
	62289	300 X 109 X 36N	125S, 212T2, 225S
	62298	300 X 109 X 39N	130S, 135S, 230S, 235S
	62413	400 X 72,5 X 72W	150S, 254S
62417	400 X 72,5 X 74KW	CZ55N	
62419	400 X 72,5 X 74W	CZ55	
LIFTON	62250	230 X 72 X 56	TD15
LINK BELT	62439	450 X 73,5 X 80	1600, LS1600C
LUMESA	28351	200 X 72 X 39	LUMESA
MAEDA	62216	180 X 72 X 40	MC104C
MANITOU	28326	230 X 72 X 43	1.16S
MASSEY FERGUSON	28330	230 X 96 X 31	114, 115
	62332	300 X 52,5 X 82W	131
	62296	300 X 109 X 38W	125, 128
	62302	300 X 109 X 40W	131, MF130
	62387	350 X 108 X 42	MF135
	62412	400 X 72,5 X 72N	MF145, MF150
MAWECO	28346	200 X 72 X 34	703
	28326	230 X 72 X 43	TB10, TC10
	62247	230 X 72 X 44	1003, 640.3
	28355	230 X 72 X 48	302
	62248	230 X 72 X 50	YFW BR
	62268	250 X 72 X 47	1003
	62271	250 X 72 X 50	YFWBR

Brand	Art./Ref.	Misura/Size	Applicazione/Application
MAXIMA	28335	180 X 72 X 34	G510L, IC20
	28346	200 X 72 X 34	G510L, IC20
	62236	230 X 48 X 68	TB16
	28326	230 X 72 X 43	TB15
	62369	320 X 100 X 46	TB36
MECALAC	62436	450 X 71 X 84	8MCR
MENZIMUCK	28340	200 X 72 X 42	C 14, C 19
MERLO	28335	180 X 72 X 34	CINGO M6
	62212	180 X 72 X 35	CINGO M6, CINGO M8
	62246	230 X 72 X 40	CINGO M10
MESSERSI	62202	150 X 72 X 34	TCH09
	28335	180 X 72 X 34	CH1, CH2, CH3, CM1
	28329	180 X 72 X 37	CH 2/R, M08
	62234	230 X 48 X 64	M18BE/C
	28334	230 X 72 X 45	M08E, M15, M16, M18, M20
	84530	230 X 72 X 52	TCH12, TCH15, TCH1500, TCH155
	28360	230 X 96 X 32	M18BE/C
	28331	230 X 96 X 33	M18BE, MS16BV
	62266	250 X 72 X 45	M08E, M15, M16, M18, M20
	62272	250 X 72 X 52	TCH12, TCH15, TCH155
	84581	250 X 96 X 40	M22U
	62325	300 X 52,5 X 78N	35PG
	62331	300 X 52,5 X 82N	M32
	62352	300 X 55 X 72	M25, M28
	62353	300 X 55 X 74	M25
	62355	300 X 55 X 78	M30, M35
	62413	400 X 72,5 X 72W	M50
MINICARRIER	28326	230 X 72 X 43	TL 10, YB10
	28334	230 X 72 X 45	YEW5D1, YFW5
	62266	250 X 72 X 45	YEW5D1, YFW5
	62271	250 X 72 X 50	YEW8D, YFWBR
	62398	350 X 90 X 44	TL20
MINICRUSHER	62242	230 X 48 X 80	MINICRUSHER
MINIDIG	28335	180 X 72 X 34	G500
	62226	200 X 72 X 37	GR700A, GR900
MINITRACK	28346	200 X 72 X 34	709
	28327	230 X 72 X 42	808
	62247	230 X 72 X 44	1003
	84530	230 X 72 X 52	1003
	84590	280 X 72 X 48	1302
MITSUBISHI	62201	150 X 72 X 33	ME05
	28342	180 X 60 X 34	
	28344	180 X 72 X 36	ME 08, ME 08B, MM 08B
	28334	230 X 72 X 45	MS010
	28330	230 X 96 X 31	MM15.7, MM15T
	28331	230 X 96 X 33	ME 15, MH15, MM15
	62251	230 X 96 X 37	MX15
	62266	250 X 72 X 45	MS010
	62317	300 X 52,5 X 72W	MM25
	62320	300 X 52,5 X 74W	20SR, ME20, ME25, MM20, MM20CR, MM20SR, MM20T
	62323	300 X 52,5 X 76W	MM25, MM25T
	62336	300 X 52,5 X 84W	MM35, MM35B, MM35T, MM40SR
	62287	300 X 109 X 35W	MM25
	62290	300 X 109 X 36W	ME20, ME25
	62299	300 X 109 X 39W	ME30, ME35, MX35

Brand	Art./Ref.	Misura/Size	Applicazione/Application
MITSUBISHI	62362	320 X 100 X 38	MS020
	62363	320x100x40.	MS020, MXR30
	62366	320 X 100 X 43	MS020, MS030, MS035, MS30SR, MXR30, MXR35, MXR35SR
	62409	400 X 72,5 X 70W	ME40, ME45, MX45
	62413	400 X 72,5 X 72W	MM40B, MM40CR, MM40T, MM45, MM45B, MM45T, MM55, MM55SR, MM57SR, MX45
	62430	420 X 100 X 52	MS040
	62431	420 X 100 X 54	MX55, MXR50, MXR55
MOROOKA	84645	450 X 100 X 65	MST500, MST600V
	84652	500 X 90 X 78	MST600, MST600V, MST600VD
MULTIDRILL	28335	180 X 72 X 34	SL
	62234	230 X 48 X 64	PL
	84530	230 X 72 X 52	ML
	28360	230 X 96 X 32	PL
	62272	250 X 72 X 52	ML
NAGANO	28335	180 X 72 X 34	ES-80, ES-90
	28344	180 X 72 X 36	NS08.2
	62214	180 X 72 X 38	MX08XT
	28346	200 X 72 X 34	ES90
	62232	230 X 48 X 60	T15S, T15V
	28326	230 X 72 X 43	ES180.2, MX14.1
	28331	230 X 96 X 33	ES-150, HIGHLAND NS 15-2, MX-15, MX-16XT, NAGANO ES-180, NS 15, TS 15, TS15S, TS17SE
	62251	230 X 96 X 37	NS20, TS20
	62319	300 X 52,5 X 74N	YS27S
	62323	300 X 52,5 X 76W	T25S
	62328	300 X 52,5 X 80N	TS30R
	62337	300 X 52,5 X 86N	NS35.2A, NS35.2B
	62352	300 X 55 X 72	ES300, NS25, TS25
	62355	300 X 55 X 78	NB30, NS30, NS35, TS35
	62357	300 X 55 X 82	ES400, NS35.2, T35S
	84601	320 X 54 X 74	TS25
	62377	320 X 54 X 78	TS30
	84604	320 X 54 X 82	MX35
	62409	400 X 72,5 X 70W	NS45, TS45, TS45S
62413	400 X 72,5 X 72W	ES500, MX50, NS45.2, T45S, TS45	
62437	450 X 71 X 86	MX80	
NANTE	62234	230 X 48 X 64	NT16
	62438	450 X 71 X 88	NT80
NEUSON	28329	180 X 72 X 37	803
	84526	230 X 48 X 70K	EH16
	62246	230 X 72 X 40	1600
	28326	230 X 72 X 43	1200, 1200 RD, 1202, 1302, 1302 RD, 1302 RD SLR, 1400 RD, 1402, 1402 RD, 1402 RD PRIMUS, 1402 RD SLR, 1500, 1500 RD, 1500 RD SLR, 1501, 1502, 1502 RD, 1502 RD SLR, 1600, 1902 RD SLR, 2000, 2000 RD, 2100, 2100 RD, 2300, 2300 RD, 2500, 2500 RD, 2700, 2700 RD
	28331	230 X 96 X 33	1402 RD FORCE, 1402 RD SLR PRIMUS, 1402RD, 1402RD SLR, 1403, 1403RD, 1404, 1502 RD FORCE, 1702, 2201, ME 1402 US MARKET
	28365	230 X 96 X 36	1503, 1503RD, 1703, 1902 RD FORCE, 1902FORCE, 1902RD, 2202 RD FORCE, 2202RD
	62275	250 X 72 X 56	TD15, TD18
	84580	250 X 96 X 38	1903, 1903RD, 2203, 2203RD
	62319	300 X 52,5 X 74N	2600, 2600RD, 2702, 2702RD, 2702RDSRL, 2800, 2902, 2902RD FORCE
	62323	300 X 52,5 X 76W	2503, 2503RD
	62328	300 X 52,5 X 80N	3000, 3200RD, 3402, 3602, 3602RD, 3602RDFORCE, 3602RDSRL
	62332	300 X 52,5 X 82W	2823
	62336	300 X 52,5 X 84W	3503, 3503RD, 3503RD VARIO, 3703, 3703RD
	62352	300 X 55 X 72	2702 RD FORCE, 2702 RD SCR, 2800RD, 2902RD
	62289	300 X 109 X 36N	2600RD
	62293	300 X 109 X 37W	2503, 2503RD

Brand	Art./Ref.	Misura/Size	Applicazione/Application
NEUSON	62296	300 X 109 X 38W	3003, 3003RD
	62305	300 X 109 X 41W	3503, 3503RD, 3503RD VARIO, 3703, 3703RD
	62366	320 X 100 X 43	2600ALT, 2600RD, 2800ALT, 2800RD, 3000RD, 3200RD
	62417	400 X 72,5 X 74KW	5000RD, 5001, 5001RD, 5001RDSRL, 5002, 5002 POWER, 5002RD, 5023RD, 6002, 6002RD, 6003RD
	62419	400 X 72,5 X 74W	5000RD, 5001, 5001RDSRL, 5002, 5002POWER, 5002RD, 501RD, 5023RD, 6002, 6002RD, 6003RD
	62436	450 X 71 X 84	7002RD, 8002, 8002RD
	62437	450 X 71 X 86	7023RD, 7523
	62441	450 X 76 X 80	8003RD
NIBBI	62207	180 X 60 X 38	NTR350
	28335	180 X 72 X 34	NTR500, NTR500D
NIKO	28343	180 X 60 X 37	HP400, HP500, HP510, HP515, HP516
	62207	180 X 60 X 38	HY13/11
	84523	200 X 72 X 38	HY610, HY710
	28334	230 X 72 X 45	HY38/16A, HY38/FS
	28326	230 X 72 X 43	HY27/16, HY38/16
	84530	230 X 72 X 52	HY48/2000, HY60
	NISSAN	62201	150 X 72 X 33
28344		180 X 72 X 36	H 08-2, H08, N 80-2, N 80-2R, N080, N80, S&B08
28329		180 X 72 X 37	H08.1, H08A, H80, H80.2, N080.3LR
62214		180 X 72 X 38	H08B, N050, N080, N080.2LR
62239		230 X 48 X 74	H22B
28326		230 X 72 X 43	N120, N120R, N150, N150R
28334		230 X 72 X 45	N06, N060, N120R, N6, RK15
28357		230 X 72 X 46	100B3, RT100, RT1000, RT1000B3, RT100B3, RT100D3, RT80
28330		230 X 96 X 31	H12A, H15, H15A, H15B, H15PLUS
28331		230 X 96 X 33	150N, H12B PLUS.2, H15, H15.1, H15A, H15B.2, N120.2, N150.2, N150.2R
62251		230 X 96 X 37	NS20, S&B150, S&B150.2
62266		250 X 72 X 45	N06, N060, N120, N120R, N6, RK15
62319		300 X 52,5 X 74N	H22A, H24A, H26B, H27, N220.2, N230.2, N230.2R, N250.2, N260.2, N300.2, NS25
62328		300 X 52,5 X 80N	H29A, H30.2, H36A, N300.2, N300.2R, N350.2, S&B300, S&B300.2
62352		300 X 55 X 72	H22, H24, H24A, H26B, H27.2
62355		300 X 55 X 78	H29A, H30, H30.2, H30A, H35A
62357		300 X 55 X 82	H36B
62289		300 X 109 X 36N	230.2, 230.2R, 250.2, 260.2, 300.2, H22, H24, H27, H27.2, N220.2, NS25
62298		300 X 109 X 39N	H30, H35, H36A, N300.2, N300.2R, N350.2, N350.2R, S&B300, S&B300.2
62299		300 X 109 X 39W	N35, S&BX.1
62362		320 X 100 X 38	N219, N220, N220R, N220RC18, N250, N250R, N250RC18
62363		320x100x40.	N15, N20, N220, N220R, N250, N250R, N300, N300R, N350R, S&B1, S&B12, S&B12R, S&B15R, S&B15RC, S&B15S, S&B15SR, S&B20, S&B20S, S&B20SR, S&BX.1, X1
62366		320 X 100 X 43	N15, N20, N220R, N250, N250R, N300, N300R, N320, N350, N350.2, N350R, N350R.2, N350RH, S&B1, S&B115, S&B15, S&B15R, S&B15RC, S&B15S, S&B15SR, S&B20, S&B20.5, S&B20R, S&B20S, S&B20SR, S&B220
62409		400 X 72,5 X 70W	H45, N400.2, N450.2, N450.2R, S&B480
62413		400 X 72,5 X 72W	H50B
62417		400 X 72,5 X 74KW	S&B25.1, S&B25.2
62419		400 X 72,5 X 74W	S&B25.1, S&B25.2
62430		420 X 100 X 52	N450, N450R, N550.2
62431		420 X 100 X 54	N550.2, S&B225, S&B25, S&B30, S&B30R, S&B30S, S&B330, S&B500, S&B550, S&B580
62437		450 X 71 X 86	H75B
62448	450 X 81 X 78N	S&B45	
84640	450 X 90 X 58	RT400, RT400E1	
NOZAWA	28346	200 X 72 X 34	DP 41
	28351	200 X 72 X 39	CP3LLD 2
	62245	230 X 72 X 39	CP3LLD2
	28357	230 X 72 X 46	CP6DD

Brand	Art./Ref.	Misura/Size	Applicazione/Application
OELLE	28335	180 X 72 X 34	500.6
OIL & STEEL	28335	180 X 72 X 34	1055, 1265
	62216	180 X 72 X 40	1765
	62276	250 X 72 X 57	1690, 1695
	62366	320 X 100 X 43	2714
ORESTEIN & KOPPEL	28326	230 X 72 X 43	RH1.1
	28334	230 X 72 X 45	CITY, CITY 2.1, RH 1.1, RH 1.15, RH 1.2, RH 2, RH 2.1, RH1, RN 1.1, RN 2.1
	84530	230 X 72 X 52	RH1.20
	28331	230 X 96 X 33	RH1.17, RH1.21
	62258	250 X 52,5 X 76K	RH1.25
	62259	250 X 52,5 X 76N	RH1.20SR2
	62266	250 X 72 X 45	CITY, CITY 2.1, RH1, RH1.1, RH1.15, RH1.2, RH2, RH2.1, RN1.1, RN2.1
	62272	250 X 72 X 52	RH1.20
	62331	300 X 52,5 X 82N	RH1.30SR2
	84595	300 X 52,5 X 88K	RH1.35SR2
	62352	300 X 55 X 72	RH1.29, RH1.35, RH2.29
	62355	300 X 55 X 78	RH1.35
	62363	320x100x40.	RH1.3, RH1.30
	62366	320 X 100 X 43	RH1.30, RH1.45
	62370	320 X 100 X 48	RH1.4, RH2.2, RH2.4
	62413	400 X 72,5 X 72W	RH1.48
	62423	400 X 74 X 68	RH1.40SR2
62424	400 X 74 X 72	RH1.45SR2	
ORMAC	28335	180 X 72 X 34	H2
ORTECO	62366	320 X 100 X 43	270/11, 270LL
PALAZZAGLI	28335	180 X 72 X 34	FZ50
	28351	200 X 72 X 39	FZ80
	28334	230 X 72 X 45	FZ120
PALAZZANI	28364	230 X 96 X 40	TSJ24.2
	62272	250 X 72 X 52	TZ170
	84581	250 X 96 X 40	TSJ23, TSJ24
	62366	320 X 100 X 43	RAGNOT 1.20, TSJ18
	62373	320 X 100 X 52	XTJ20.C
PAUS	62234	230 X 48 X 64	MB1.6
PAUS - PAUSELLI	62272	250 X 72 X 52	MB2.0, DC1
PAUS	62357	300 X 55 X 82	MB3.2
PAUSELLI	62272	250 X 72 X 52	DC1
PAZZAGLIA	28335	180 X 72 X 34	FZ50
	62245	230 X 72 X 39	FZ100, FZ110
	28334	230 X 72 X 45	FZ150
	62266	250 X 72 X 45	FZ120, FZ150, FZ160
PELJOB ECOMAT	62238	230 X 48 X 72	EB200, EB200XT, EB200XTV, EB263, EC20, EC20B, EC20BXTV
	28326	230 X 72 X 43	650S, EB 10, EB 10.4, EB 11, EB 12, EB 12.4, EB 14, EB 14.2, EB 14.4, EB 150 XR, EB271, EC 14, EC15BXR, SIRIUS, SIRIUS 271, SIRIUS PLUS
	28358	230 X 72 X 47	EB11, EB16, EB16.4, EB16.5
	28331	230 X 96 X 33	EB 150 XT, EB 150 XTV, EB150, EC 15, EC 15 BI _SPEED, EC 15 BI _SPEED/ADJU.WIDTH, EC 15 XR, EC13, EC15B
	62268	250 X 72 X 47	16.5, EB11, EB16, EB16.4
	84579	250 X 96 X 36	EB200, EB200XT, EB200XTV, EB263, EC20, EC20B, EC20BXTV
	62317	300 X 52,5 X 72W	EB224.4, EB25.4, EB28.4, EB30.4
	62336	300 X 52,5 X 84W	EB250, EB252, EB28, EB306, EB350, EB350XT, EB36, EB400, EB406, EC35, LS286, LS386, LS406
	62287	300 X 109 X 35W	EB22.4, EB25.4, EB28.4, EB30.4
	62296	300 X 109 X 38W	EB250, EB250XT, EB300, EC25, EC30
	62305	300 X 109 X 41W	EB250, EB252, EB28, EB306, EB350, EB350XT, EB36, EB400, EB406, EC35, LS286, LS406

Brand	Art./Ref.	Misura/Size	Applicazione/Application
PELJOB ECOMAT	62362	320 X 100 X 38	EB22, EB22.4, EB27
	62366	320 X 100 X 43	EB36
	62406	400 X 72,5 X 68W	EB450, EC45
	62409	400 X 72,5 X 70W	EB506, EC50, LS502
	62413	400 X 72,5 X 72W	EB506
	62417	400 X 72,5 X 74KW	EC55, EC55B
	62419	400 X 72,5 X 74W	EC55, EC55B
	62434	450 X 71 X 80	EB706, EC70
PENTAMOTER	28327	230 X 72 X 42	JOLLY
	28334	230 X 72 X 45	JOLLY 26PK, MAXI DUMPER
PICCINI	28335	180 X 72 X 34	MINICAR 300
	28340	200 X 72 X 42	MINICAT 13
	62245	230 X 72 X 39	MINI 22
	28327	230 X 72 X 42	MINICAR 500, MINICAT 13
	28326	230 X 72 X 43	DUMPER, MINICAT 20, MINICAT 22
	62362	320 X 100 X 38	MINI30, MINICAT30, MINICAT32
	PORELLO	28335	180 X 72 X 34
28327		230 X 72 X 42	CAR100
POWERFAB	62199	200 x 72 x 35	1200X
	62227	200 X 72 X 40	100X, 1200SX, 1250, 1700SX, 7006, HIGH TYPE, HSS11
	28327	230 X 72 X 42	SAMURAI
POWERPAC	62207	180 X 60 X 38	RC350, RC500
RAMPICAR	28342	180 X 60 X 34	R600
	28343	180 X 60 X 37	R400
	62209	180 X 72 X 30	FRESIA/RAMPICAR
	28335	180 X 72 X 34	R 600
RAPID	28342	180 X 60 X 34	M30, P30
	28343	180 X 60 X 37	DS601, M450, P45
	62210	180 X 72 X 31	405
ROCK	28342	180 X 60 X 34	P30
	28343	180 X 60 X 37	BFP602, DSP601, M450, P45
	28326	230 X 72 X 43	20
ROSSI	28326	230 X 72 X 43	20, R103.3, R105.3
ROTAIR	28343	180 X 60 X 37	R500
	62207	180 X 60 X 38	R35, R50
	28335	180 X 72 X 34	R600, R70, R800
	62215	180 X 72 X 39	R
	62228	200 X 72 X 41	R900
	28358	230 X 72 X 47	R625
RUFENERKIPPER	28335	180 X 72 X 34	RK500
	28327	230 X 72 X 42	RK900 - 2
	28334	230 X 72 X 45	RK1100, RK1200
	28355	230 X 72 X 48	RK1100-R, RK1500
	84591	280 X 72 X 52	RK 1800.2
SACET	62276	250 X 72 X 57	KC28ALV
SANDQUEEN	28327	230 X 72 X 42	DUMPER
SATO	28342	180 X 60 X 34	SC 156 DD, SC 156 DS
	84513	180 X 60 X 36	SC161DC, SC 61DS
	62212	180 X 72 X 35	SC433DH
	62199	200 x 72 x 35	SC433LDA, SC433LDS
SCATTRACK	28334	230 X 72 X 45	116, 516, 520, 520V
	62328	300 X 52,5 X 80N	533, 535

Brand	Art./Ref.	Misura/Size	Applicazione/Application
SCATTRACK	62352	300 X 55 X 72	530
	62355	300 X 55 X 78	130, 135
	62290	300 X 109 X 36W	125
	62298	300 X 109 X 39N	533, 535
	62413	400 X 72,5 X 72W	150
SCHAEFF	28344	180 X 72 X 36	HR1
	28326	230 X 72 X 43	HR02
	28334	230 X 72 X 45	HR2, N120
	28331	230 X 96 X 33	H15, HR 02, HR 12, HR 2, HR11, HR13
	62266	250 X 72 X 45	HR02, HR2, N120
	62319	300 X 52,5 X 74N	H24, H26B, H27, HR24, HR27, HR4A, N250.2, N260.2
	62328	300 X 52,5 X 80N	HR8, HR8A
	62337	300 X 52,5 X 86N	HR3.7
	62352	300 X 55 X 72	HR14
	62355	300 X 55 X 78	HR16, HR35
	62289	300 X 109 X 36N	H24, H27, HR24, HR27
	62363	320x100x40.	H3, HR3, HR4, N220
	62366	320 X 100 X 43	H10, H100, H5, HR10, HR5, HR8, N300, N350
	62413	400 X 72,5 X 72W	HR18
	62420	400 X 72,5 X 76W	HR20, HR21, HR22
	62437	450 X 71 X 86	HR32, HR32CI
62447	450 X 81 X 76W	HR31	
SEDIRILL	28326	230 X 72 X 43	210, 250
	84530	230 X 72 X 52	210
SHIN-TOWA	28344	180 X 72 X 36	CL100
	62215	180 X 72 X 39	NC 180
	84522	200 X 72 X 36	CL100
	62227	200 X 72 X 40	CC154, CC235
	28326	230 X 72 X 43	CC104, CC204, CC205, CC265, CC266, CC285, TC204
SILLA	28326	230 X 72 X 43	14
	28334	230 X 72 X 45	ME1400H
	28355	230 X 72 X 48	18
SUMITOMO	62211	180 X 72 X 33	LS200FXJ, S10FX, S200FXJ, SH4GX3, SH4J
	28329	180 X 72 X 37	LS300FXJ, S 30 FX, SH 7GX3, SH7J
	62228	200 X 72 X 41	S30UX1, SH9UX
	62234	230 X 48 X 64	SH15J
	62242	230 X 48 X 80	SH18UJ, SH18UJ2, SH20JX
	28332	230 X 72 X 41	SH 9UX
	28326	230 X 72 X 43	LS500FXJ, LS600FXJ, LS600FXJ3, LS600PXJ3, S 50 F2, S 60 F2, S50F2K, S50K
	28358	230 X 72 X 47	SH10UJ3, SH12JX, SH9UX2, SH9UX3
	28360	230 X 96 X 32	SH 15J
	84571	230 X 96 X 35	SH18J
	84581	250 X 96 X 40	SH18UJ, SH18UJ2, SH20JX
	62317	300 X 52,5 X 72W	LS700FXJ2, LS700FXJ3, LS800FXJ3, S70FX2, SH25J
	62320	300 X 52,5 X 74W	S80F2, S80FXZ
	62323	300 X 52,5 X 76W	LS8000FXJ2, LS800FXJ3, S80F2, S80FX2, S80FXJ3, SH25JX, SH28J
	62336	300 X 52,5 X 84W	LS1000FXJ2, LS1000FXJ3, S100, S100F2, S100FJ3, SH30JX, SH30JX2, SH32J, SH35J
	62343	300 X 52,5 X 90W	SH35JX, SH35JX2, SH35UJ, SH38UJ, SH38UJ2, SH40UJ2
	62290	300 X 109 X 36W	S80F2, S80FXZ
	62299	300 X 109 X 39W	S90, S90F2, S90FX3, S90FXJ3
	62305	300 X 109 X 41W	S100, S100F2, S100FJ3
	62409	400 X 72,5 X 70W	LS1200FXJ2, LS1200FXJ3, S120, S120F2
	62413	400 X 72,5 X 72W	55U2, SH40JX, SH40JX2, SH45J, SH55U, SH55U2
	62417	400 X 72,5 X 74KW	LS1300FXJ2, LS1300FXJ3, LS1350UXJ, S130, S130F2, SH135, SH55J, SH55UJ
	62419	400 X 72,5 X 74W	LS1300FXJ2, LS1300FXJ3, LS1350UXJ, S130, S130F2, SH135, SH55J, SH55UJ
	84617	400 X 72,5 X 76W	SH65U.2
62435	450 X 71 X 82	SH60, SH65U.1, SH65UJ	



Brand	Art./Ref.	Misura/Size	Applicazione/Application
SUMITOMO	62438	450 X 71 X 88	LS160LC
	62439	450 X 73,5 X 80	JS70, LS160, S160B2, S160FJ2, SH60, SH60.2
	62440	450 X 73,5 X 86	S106F2U, S160E, S160F2U, SH75, SH75U, SH75U.2, SH75URG, SH75X.2, SH75XU.2
SUNWARD	62236	230 X 48 X 68	SWE15, SWE17
	62355	300 X 55 X 78	SWE28
	62358	300 X 55 X 84	SWE38
	62412	400 X 72,5 X 72N	SWE50, SWE55
	62422	400 X 72,5 X 82W	SWE70
TADANO	62215	180 X 72 X 39	AC40, AC45SG, AC65SG
TAKEUCHI	28335	180 X 72 X 34	HUPPI 403, TAK700
	28329	180 X 72 X 37	TB007, TB07, TB108
	62215	180 X 72 X 39	TB08
	62199	200 x 72 x 35	TC425LD
	28351	200 X 72 X 39	TB008, TB08, TB850B
	62227	200 X 72 X 40	TC850, TC850S, TCF850
	28340	200 X 72 X 42	TC 850 S
	62236	230 X 48 X 68	TB016S/LSA
	28326	230 X 72 X 43	TB 10S, TB 120R, TB 14, TB 15, TB 650 S, TB105, TB106, TB12, TB120, TB16, TB650, TL10, TZ10
	62247	230 X 72 X 44	HUPPI 640
	28334	230 X 72 X 45	TC960D3
	28357	230 X 72 X 46	TC960D3S, TC980
	28330	230 X 96 X 31	TB 015, TB 980, TL10
	28350	230 X 96 X 34	TB 016
	84571	230 X 96 X 35	TB15F, TB15FR
	84574	230 X 101 X 30	TB15
	62254	250 X 47 X 84	TB23
	62317	300 X 52,5 X 72W	TB020
	62332	300 X 52,5 X 82W	TB030, TB25, TB28FR, TB30UR
	62302	300 X 109 X 40W	TB30UR
	84611	320 X 86 X 46T	TL120, TL220
	84612	320 X 86 X 48T	TL126, TL26
	84613	320 X 86 X 52T	TL130, TL230
	62361	320 X 100 X 37	TB800, TB800R
	62362	320 X 100 X 38	TB20, TB20QR, TB21, TB22
	62363	320x100x40.	TB25, TB250, TZ330
	62366	320 X 100 X 43	TB1200, TB250, TB250R, TB300, TB300R, TB350R, TB350R, TZ25, TZ250, TZ250R, TZ26
	62369	320 X 100 X 46	TB300, TB35, TB350, TB350R, TB355, TB36, TB36S, TZ230
	62391	350 X 52,5 X 86	TB035, TB135, TB138, TB235
	62413	400 X 72,5 X 72W	TB55R, TB55UR
	62418	400 X 72,5 X 74N	TB045, TB145, TB153FR, TB250(NEW), TB53FR
	62447	450 X 81 X 76W	TB070, TB175, TB180FR, TB80, TB80FR
84644	450 X 100 X 48	TL140, TL240	
62432	450 X 100 X 50	TL150, TL250	
TANAKA	28329	180 X 72 X 37	DC400
	62216	180 X 72 X 40	DC250
	62226	200 X 72 X 37	DC152, DC153
	28357	230 X 72 X 46	DC202, DC224, DC31
TAYLOR CONST. PLANT	28343	180 X 60 X 37	TCP 500 (CARRIER UK-MKT)
	62210	180 X 72 X 31	TCP500
TECNIWELL	28344	180 X 72 X 36	TWH5
TEKNA	28335	180 X 72 X 34	TC9
	28329	180 X 72 X 37	T13
	28326	230 X 72 X 43	K 14/M, K 14/S, K14, K15
	28331	230 X 96 X 33	K15
TEREX	28331	230 X 96 X 33	TC15, TC16

Brand	Art./Ref.	Misura/Size	Applicazione/Application
TEREX	62337	300 X 52,5 X 86N	AM37R, TC37
	62352	300 X 55 X 72	TC29
	62355	300 X 55 X 78	TC35
	62413	400 X 72,5 X 72W	TC48, TC50
	62420	400 X 72,5 X 76W	TC60
	62437	450 X 71 X 86	TC75
TERRAJET	28326	230 X 72 X 43	2514B, 5515A, CITYJET, TERRAJET
TEUPEN	28326	230 X 72 X 43	LEO 23H, LE016GT, LE016H, LE016T, LE022T, LE023T, LE025, LE025T
	84530	230 X 72 X 52	LE026
	62276	250 X 72 X 57	LE026T, LE030, LE030T, LE036, LE036T
UNIMOV	62227	200 X 72 X 40	1250
	62246	230 X 72 X 40	1250
UTEX	28326	230 X 72 X 43	1.03
VENIERI	28326	230 X 72 X 43	VF121, VF141, VF161, VF171
VOLVO	62238	230 X 48 X 72	EC20(BI-SPEED), EC20B, EC20BXTV
	28326	230 X 72 X 43	EC14, EC15BXR, EC15R, EC15RB
VOLVO	28331	230 X 96 X 33	EC13, EC13XR, EC15, EC15 BI-SPEED, EC15B, EC15T, EC15TB, EC15V, EC15VB, EC15XR, EC15XT, EC15XTV
	84579	250 X 96 X 36	EC20B, EC20BI, EC20BXTV, EC20T, EC20TB, EC20V, EC20VB, EC20XT, EC20XTV, SPEED
	84585	250 X 109 X 38	EC27C, ECR28, ECR30
	62336	300 X 52,5 X 84W	EC35, ECR38
	62296	300 X 109 X 38W	EC25, EC25X, EC30, EC30X
	62305	300 X 109 X 41W	EC35, EC35C, ECR38
	62406	400 X 72,5 X 68W	EC45
	62409	400 X 72,5 X 70W	EC50
	62413	400 X 72,5 X 72W	ECR48C
	62417	400 X 72,5 X 74KW	EC55, EC55B, ECR58 PLUS
	62419	400 X 72,5 X 74W	EC55, EC55B, ECR58 PLUS
	62434	450 X 71 X 80	EC70, EC70B
	62447	450 X 81 X 76W	ECR88 PLUS
	WINBULL YAMAGUCHI	28342	180 X 60 X 34
28346		200 X 72 X 34	WB 510, WB 510B
28351		200 X 72 X 39	WB700 (MINIDUMPER), WB700EX (MINIDUMPER)
YAMAGUCHI	62211	180 X 72 X 33	WB710, WB710B
	28335	180 X 72 X 34	WB450HD, WB450MD, WB500, WB510, WB510B
	62212	180 X 72 X 35	WB600
	62215	180 X 72 X 39	WB700, WB700EX
	28346	200 X 72 X 34	WB450HD, WB450MD, WB500, WB510
	62199	200 x 72 x 35	WB600
	28351	200 X 72 X 39	WB07, WB700, WB700EX
	28334	230 X 72 X 45	WB1000.3
	28357	230 X 72 X 46	WB1000.3, WB800Z
	62248	230 X 72 X 50	WB12H
	62266	250 X 72 X 45	WB1000.3
	62271	250 X 72 X 50	WB1200, WB12H
62384	320 X 90 X 56	WB2500	
YANMAR	62200	150 X 72 X 28	B03, B03 SCOPY
	62202	150 X 72 X 34	B05, B05 SCOPY, B05R SCOPY, SV05
CHIKUSUI	28342	180 X 60 X 34	BFP402
	28343	180 X 60 X 37	CG3 HAST, MCG 100, MCG 111F
YANMAR	62210	180 X 72 X 31	MCG 131
	84515	180 X 72 X 32	B08
	62211	180 X 72 X 33	XYD710B
	28335	180 X 72 X 34	MCG 131
	62212	180 X 72 X 35	B03
	28329	180 X 72 X 37	B 08 SCOPY, B 08R SCOPY, B 08RV SCOPY, B07, B07.1, B08.3, B08.3RV, CG3D, SV08

Brand	Art./Ref.	Misura/Size	Applicazione/Application
YANMAR	62213	180 X 72 X 37K	SV08
	84517	180 X 72 X 43Y	VIO10
	84521	200 X 72 X 31	MCG 130
	28346	200 X 72 X 34	WB500, YM 10, YM10, YMD60
	62226	200 X 72 X 37	CG3 CARRIER, DC153
	84523	200 X 72 X 38	MCG 150
	28351	200 X 72 X 39	B 10, B 10R, DC153, YB 101, YB 101 UZ, YB 101 VL
	62227	200 X 72 X 40	B1, B1U
	62228	200 X 72 X 41	K4SC
	62230	200 X 72 X 47Y	B12.3, B14, B15.3, B15.3PR, B15.3X, B15.EX
	62234	230 X 48 X 64	B15
	28332	230 X 72 X 41	B 158, C 6R, CO 6R
	28326	230 X 72 X 43	B10, B12, B12.1, B12.2, B12.3, B12.3PR, B14, B14.1, B15, B17, B17.1, B17.2, B17PR, Y 12B, Y12, Y14, YB 10, YB 10.1, YB 10.2, YB 121, YB 151, YBT650
	28357	230 X 72 X 46	DC224, VIO17, WB1000.1, WB1000.3, WB1000.3S, Y14B
	84527	230 X 72 X 46Y	VIO17
	28358	230 X 72 X 47	B17.2, B17.3, B17.3EX, B17EX, B18, B18EX, SV15, SV17, VIO 15, VIO15.2
	84528	230 X 72 X 47Y	B 17.2, B 17.3, B 17.3EX, B 17EX, B 18EX, B18, SV 15, SV 17, VI 015, VI 015.2
	62248	230 X 72 X 50	5D.1, 8R, C10R, C10R.1, C10R.3, C8R, CD7CDA, FW5D1, TFW8R, YEW5D1, YEW8R, YFW8R
	28360	230 X 96 X 32	B15
	84576	250 X 48,5 X 80Y	VIO20
	62255	250 X 48,5 X 84Y	SV20, VIO20 GLOBAL, VIO20.1, VIO20.2, VIO20CR
	62271	250 X 72 X 50	5D.1, 8R, C10R, C12R, TFW8R
	84587	260 X 55,5 X 78Y	B24VA, VIO25.3
	62280	260 X 96 X 38Y	B19, B19.2, B19PR
	62283	280 X 106 X 35Y	B22, B22.1, B22.2, B22.2A, B25, B2X, B2X.1, M22, YB221
	62321	300 X 52,5 X 76K	B2U
	62325	300 X 52,5 X 78N	AURA 28
	62334	300 X 52,5 X 84K	B4U
	62349	300 X 55,5 X 76Y	B25V, B25VCR
	84596	300 X 55,5 X 78Y	VIO25, VIO27.2, VIO27.2GLOBAL
	62350	300 X 55,5 X 82Y	B27.2B, B27V, B3.3, B30V, B30VCR, B30VPR, B37.2B, B37V, B37VCR, B37VPR, VIO30.1, VIO30.2, VIO30V, VIO35.1, VIO35.2, VIO35.3, VIO35CR
	62383	320 X 90 X 52	C20R
	62384	320 X 90 X 56	C25R, C30R, C30R.1, C30RY.1, WB2500, YFW25, YFW25R
	62362	320 X 100 X 38	Y22, YB191, YB20, YB201, YB221
	62363	320x100x40.	B31, YB231, YB241, YB241Z, YB251
	62365	320 X 100 X 42	B27, B3, YB27, YB271, YB271.30
	62366	320 X 100 X 43	B37, YB21, YB21XR, YB251, YB281, YB281X, YB281X.2, YB281XR, YB28X.2, YB291, YB301, YB301.2U, YB301UZ, YB351, YB352
	62374	320 X 106 X 39Y	B27, B27.1, B27.2, B27.2A, B3, B3.2, B32, B32.2, M27, VIO30, YB27, YB271, YB32
	62397	350 X 75,5 X 74Y	VIO40.1, VIO40.2, VIO40V, VIO45, VIO45CR, VIO45SV
	62399	370 X 107 X 41Y	B37, B37.1, B37.2, B37.2A, M37
	62414	400 X 72,5 X 72Y	B5, B50, B50.2, B50.2A, B6, B6U, BB50.1, VIO50CR, VIO50PR
62425	400 X 75,5 X 74Y	B50.2B, B50V, B50VCR, B50VIO, B6.3, VIO45, VIO50.1, VIO50.2, VIO50V, VIO55, VIO55CR, VIO57	
62400	400 X 107 X 46Y	VIO40, VIO40CR, VIO40PR	
84623	400 X 144 X 36	B5, B5.2, B50, B50.1, B50.2, B50.2A, B50M, B6, B6U, VIO350, VIO50, VIO50CR, VIO50PR	
62403	400 X 144 X 36Y	B5, B5.2, B50, B50.1, B50.2, B50.2A, B50M, B6, B6U, VIO350, VIO50, VIO50CR, VIO50PR	
62430	420 X 100 X 52	YB401, YB451, YB501, YB551	
62431	420 X 100 X 54	BSX, YB551XB	
62434	450 X 71 X 80	B7	
62451	450 X 83,5 X 74	B7, B7 SIGMA, B7U, VIO70, VIO70.A, VIO70CR, VIO75, VIO75.A, VIO75V, VIO80	
62452	450 X 83,5 X 74Y	B7 SIGMA, B7U, VIO75, VIO75.A, VIO75V, VIO80	
84643	450 X 90 X 76	C40	
84651	485 X 92 X 72	SV100, SV100.1	
84653	500 X 90 X 82	C50R, C50R.1, C50R.2, YFW40, YFW40R, YFW45	
YASHIMA	84513	180 X 60 X 36	IR 045

Brand	Art./Ref.	Misura/Size	Applicazione/Application
ZAVATTINI	84530	230 X 72 X 52	E19P, E9SC
	62272	250 X 72 X 52	E19P, E9SC
ZEPPELIN	28334	230 X 72 X 45	TM1
	28331	230 X 96 X 33	45, ZR 15, ZR02, ZR15, ZRH02, ZRH12
	62352	300 X 55 X 72	ZR14, ZR25, ZRH14
	62355	300 X 55 X 78	ZR35, ZRH16
	62289	300 X 109 X 36N	ZRH04, ZRH4
	62298	300 X 109 X 39N	ZRH8
	62363	320x100x40.	ZRH4
	62370	320 X 100 X 48	ZR4
	62413	400 X 72,5 X 72W	ZR45
	62420	400 X 72,5 X 76W	ZR55

**CINGOLI IN GOMMA ADATTABILI A VARIE APPLICAZIONI**
*CHENILLE CAOUTCHOUC ADAPTABLE DIVERSES APPLICATIONS*
*RUBBER TRACKING ADAPTABLE TO VARIUS APPLICATIONS*
*GUMMIRAUPEN PASSEND ZU VERSCHIEDENE ANWENDUNGEN*
*ORUGA DE GOMA ADAPTABLE DIVERSAS APLICACIONES*

Art./Ref.	Misura/Size
62204	180 X 60 X 31
84514	180 X 60 X 39
62222	190 X 72 X 37
62224	190 X 72 X 39
84519	190 X 72 X 42
84520	200 X 72 X 28
84525	200 X 72 X 43
62229	200 X 72 X 44
62233	230 X 48 X 62
62237	230 X 48 X 70
62249	230 X 72 X 54
84572	230 X 96 X 42
84573	230 X 96 X 43
62261	250 X 52,5 X 78K
62269	250 X 72 X 48
62270	250 X 72 X 49
84582	250 X 109 X 35
84584	250 X 109 X 37
84588	260 X 109 X 36
62318	300 X 52,5 X 74K
62326	300 X 52,5 X 78W
62330	300 X 52,5 X 82K
84594	300 X 52,5 X 86K
62340	300 X 52,5 X 88W
62351	300 X 55 X 70
62295	300 X 109 X 38N
62301	300 X 109 X 40N
62306	300 X 109 X 42K
62307	300 X 109 X 42N
62310	300 X 109 X 43W
71634	320 X 52,5 X 80
84599	320 X 52,5 X 84N
84600	320 X 54 X 70
62376	320 X 54 X 72
84603	320 X 54 X 80

Art./Ref.	Misura/Size
84605	320 X 54 X 84
62379	320 X 84 X 53
62380	320 X 86 X 48B
62371	320 X 100 X 49
62390	350 X 52,5 X 84
84614	350 X 90 X 47
62405	400 X 72,5 X 68K
62407	400 X 72,5 X 70K
62411	400 X 72,5 X 72K
84618	400 X 72,5 X 76Y
84619	400 X 74 X 74
84620	400 X 86 X 50
84621	400 X 86 X 55
84622	400 X 144 X 35
84624	400 X 144 X 37
84625	400 X 144 X 38
62428	420 X 100 X 48
84626	450 X 76 X 80
62442	450 X 81 X 72N
62446	450 X 81 X 76N
84628	450 X 81 X 80W
84630	450 X 81 X 82N
84629	450 X 81 X 82W
84634	450 X 83,5 X 78
62453	450 X 84 X 53B
62454	450 X 84 X 56B
84635	450 X 84 X 74
84637	450 X 86 X 58B
84638	450 X 86 X 60B
84639	450 X 90 X 54
84641	450 X 90 X 69
84642	450 X 90 X 70
84646	450 X 110 X 74
84649	460 X 102 X 51

# 1.7.24 Olii

Oils



## Ricambi & accessori per macchine agricole

SPARE PARTS & ACCESSORIES FOR AGRICULTURAL MACHINE

Tutti gli articoli della presente sezione, prodotti da AMA SPA e/o da terzi per conto di AMA, sono adattabili ("non originali") alle marche indicate ai sensi di quanto previsto dal REG. CE n. 1400/2002. I diritti sui marchi citati appartengono ai legittimi proprietari e il loro uso ha l'esclusiva finalità di consentire all'utilizzatore la comparazione dei diversi prodotti. All items of this section, manufactured by AMA SPA and/or any third party on behalf of AMA, are adaptable ("non-original") to the brands listed under the provisions of the REG. CE n. 1400/2002. The rights on the trademarks belong to their respective owners and their usage is only aimed to allow the user to compare different products.

**ENI - LINEA TRAZIONE LEGGERA**

ENI - SERIE POUR TRACTION LEGERE

ENI - LINE LIGHT TRACTION

ENI - LINE LIGHT TRACTION

ENI - LÍNEA DE LUZ DE TRACCIÓN

**Note: ENI - DROP SHIPMENTORDINI:**
**ORDINI:** Spedizione da Eni - Fatturazione da Ama.

Porto franco. Spedizione in circa una settimana data ordine.

Minimo ordine 100 kg.

 Ordini da inserire a parte, da mandare via mail a [marketing@ama.it](mailto:marketing@ama.it) o tramite il rappresentante.

 Per richieste o informazioni ulteriori contattare [marketing@ama.it](mailto:marketing@ama.it)

Art./Ref.	Note/Note	Peso Kg/Weight Kg
ENI100810	ENI I-SINT TECH 0W-30 205 LT	180 KG
ENI100830	ENI I-SINT TECH 0W-30 60 LT	48 KG
ENI100891	ENI I-SINT TECH 0W-30 12X1 LT	-
ENI100892	ENI I-SINT TECH 0W-30 6X4 LT	-
ENI100910	ENI I-SINT TECH F 5W-30 205 LT	180 KG
ENI100930	ENI I-SINT TECH F 5W-30 60 LT	48 KG
ENI100991	ENI I-SINT TECH F 5W-30 12X1LT	-
ENI100992	ENI I-SINT TECH F 5W-30 6X4 LT	-
ENI101010	ENI I-SINT TECH G 5W-30 205 LT	180 KG
ENI101030	ENI I-SINT TECH G 5W-30 60 LT	48 KG
ENI101091	ENI I-SINT TECH G 5W-30 12X1LT	-
ENI101092	ENI I-SINT TECH G 5W-30 6X4 LT	-
ENI101210	ENI I-SINT TECH P 5W-30 205 LT FS	180 KG
ENI101250	ENI I-SINT TECH P 5W-30 20 LT SE	18 KG
ENI101291	ENI I-SINT TECH P 5W-30 12X1 LT TA	-
ENI101510	ENI I-SINT TECH R 5W-30 205 LT	180 KG
ENI101530	ENI I-SINT TECH R 5W-30 60 LT	48 KG
ENI101591	ENI I-SINT TECH R 5W-30 12X1LT	-
ENI101592	ENI I-SINT TECH R 5W-30 6X4 LT	-
ENI101610	ENI I-SINT 5W-30 205 LT	180 KG
ENI101630	ENI I-SINT 5W-30 60 LT	48 KG
ENI101650	ENI I-SINT 5W-30 20 LT	18 KG
ENI101691	ENI I-SINT 5W-30 12X1 LT	-
ENI101692	ENI I-SINT 5W-30 6X4 LT	-
ENI101710	ENI I-SINT FE 5W-30 205 LT	180 KG
ENI101730	ENI I-SINT FE 5W-30 60 LT	48 KG
ENI101750	ENI I-SINT FE 5W-30 20 LT	18 KG
ENI101791	ENI I-SINT FE 5W-30 12X1 LT	-
ENI101792	ENI I-SINT FE 5W-30 6X4 LT	-
ENI101810	ENI I-SINT TECH ECO F 5W-20 205 LT	180 KG
ENI102110	ENI I-SINT MS 5W-30 205 LT	180 KG
ENI102130	ENI I-SINT MS 5W-30 60 LT	48 KG
ENI102150	ENI I-SINT MS 5W-30 20 LT	18 KG
ENI102191	ENI I-SINT MS 5W-30 12X1 LT	-
ENI102192	ENI I-SINT MS 5W-30 6X4 LT	-
ENI102210	ENI I-SINT MS 5W-40 205 LT	180 KG
ENI102230	ENI I-SINT MS 5W-40 60 LT	48 KG
ENI102250	ENI I-SINT MS 5W-40 20 LT	18 KG
ENI102291	ENI I-SINT MS 5W-40 12X1 LT	-
ENI102292	ENI I-SINT MS 5W-40 6X4 LT	-
ENI102410	ENI I-SINT 10W-40 205 LT	180 KG
ENI102430	ENI I-SINT 10W-40 60 LT	48 KG
ENI102491	ENI I-SINT 10W-40 12X1LT	-
ENI102492	ENI I-SINT 10W-40 6X4LT	-
ENI103310	ENI I-BASE 15W-40 205 LT	180 KG
ENI103330	ENI I-BASE 15W-40 60 LT	48 KG
ENI103350	ENI I-BASE 15W-40 20 LT	18 KG

Art./Ref.	Note/Note	Peso Kg/Weight Kg
ENI103391	ENI I-BASE 15W-40 12X1LT	-
ENI103392	ENI I-BASE 15W-40. 6X4 LT	-
ENI103510	ENI I-SINT PROFES L 5W/40 180KG	180 KG
ENI103530	ENI I-SINT PROFES L 5W/40 48KG	48 KG
ENI103550	ENI I-SINT PROFES L 5W/40 18KG	18 KG
ENI103810	ENI I-SINT PROF 10W-40 205 LT	180 KG
ENI103830	ENI I-SINT PROF 10W-40 60 LT	48 KG
ENI103850	ENI I-SINT PROF 10W-40 20 LT	18 KG
ENI103910	ENI I-BASE PROF 15W-40 205 LT	180 KG
ENI103930	ENI I-BASE PROF 15W-40 60 LT	48 KG
ENI103950	ENI I-BASE PROF 15W-40 20LT	18 KG
ENI103991	ENI I-BASE PROF 15W-40 12X1 LT	-
ENI103992	ENI I-BASE PROF 15W-40 6X4 LT	-
ENI104310	ENI I-SINT 0W-40 205 LT FS	180 KG
ENI104350	ENI I-SINT 0W-40 20 LT SE	18 KG
ENI104391	ENI I-SINT 0W-40 12X1 LT TA	-
ENI104392	ENI I-SINT 0W-40 6X4 LT TA	-
ENI104410	ENI I-SINT 0W-20 205 LT FS	180kg
ENI104450	ENI I-SINT 0W-20 20 LT SE	18 KG
ENI104491	ENI I-SINT 0W-20 12X1 LT TA	-
ENI104492	ENI I-SINT 0W-20 6X4 LT TA	-
ENI132610	ENI I-BASE PROFESSIONAL 10W-40 205 L FS	180 KG
ENI132630	ENI I-BASE PROFESSIONAL 10W-40 60 LT FT	48 KG
ENI102310	ENI I-SINT 5W-40 205 L	180 KG
ENI102330	ENI I-SINT 5W-40 60 LT	48 KG
ENI102391	ENI I-SINT 5W-40 12X1LT	-
ENI102392	ENI I-SINT 5W-40 . 6X4 LT	-

#### ENI - LINEA TRAZIONE PESANTE

ENI - LES VEHICULES LOURDS

ENI - HEAVY DUTY VEHICLES

ENI - SCHWERE NUTZFAHRZEUGE

ENI - VEHICULOS PESADOS

Art./Ref.	Note/Note	Peso Kg/Weight Kg
ENI101310	ENI I-SIGMA SPECIAL TMS 10W-40 205 L	180 KG
ENI101350	ENI I-SIGMA SPECIAL TMS 10W-40 20 L	18 KG
ENI106410	ENI I-SIGMA TOP MS 15W-40 205LT	180 KG
ENI106430	ENI I-SIGMA TOP MS 15W40 60 LT	48 KG
ENI106450	ENI I-SIGMA TOP MS 15W-40 20LT SE	18 KG
ENI106610	ENI I-SIGMA TOP MS 10W-40 205LT	180 KG
ENI106630	ENI I-SIGMA TOP MS 10W40 60 LT	48 KG
ENI106650	ENI I-SIGMA TOP MS 10W-40 20LT SE	18 KG
ENI106710	ENI I-SIGMA TOP MS 10W-30 205LT	180 KG
ENI106730	ENI I-SIGMA TOP MS 10W30 60 LT	48 KG
ENI106750	ENI I-SIGMA TOP MS 10W30 20 LT	18 KG
ENI106810	ENI I-SIGMA TOP MS 5W-30 205LT	180 KG
ENI106830	ENI I-SIGMA TOP MS 5W-30 60 LT	48 KG
ENI106850	ENI I-SIGMA TOP MS 5W-30 20LT SE	18 KG
ENI106910	ENI I-SIGMA TOP 10W-40 205 LT	180 KG
ENI106930	ENI I-SIGMA TOP 10W-40 60 LT FS	48 KG
ENI106950	ENI I-SIGMA TOP 10W-40 20 LT	18 KG
ENI107010	ENI I-SIGMA TOP 5W-30 205 LT	180 KG
ENI107030	ENI I-SIGMA TOP 5W-30 60LT FT	48 KG
ENI107050	ENI I-SIGMA TOP 5W-30 20 LT	18 KG
ENI108010	ENI I-SIGMA PERF.E7 15W-40 205LT	180 KG
ENI108030	ENI I-SIGMA PERFORMANCE E7 15W-40 60LT	48 KG

Art./Ref.	Note/Note	Peso Kg/Weight Kg
ENI108050	ENI I-SIGMA PERF E7 15W-40 20LT	18 KG
ENI108092	ENI I-SIGMA PERFORMANCE E7 15W-40 6X4LTA	-
ENI108110	ENI I-SIGMA PERF E4 10W-40 205LT	180 KG
ENI108130	ENI I-SIGMA PERFORMANCE E4 10W-40 60LT	48 KG
ENI108150	ENI I-SIGMA PERF E4 10W-40 20LT	18 KG
ENI108210	ENI I-SIGMA PERF E3 15W-40 205LT	180 KG
ENI108230	ENI I-SIGMA PERF E3 15W-40 60LT	48 KG
ENI108250	ENI I-SIGMA PERF E3 15W-40 20LT	18 KG
ENI108292	ENI I-SIGMA PERF E3 15W-40 6X4LT	-
ENI108310	ENI I-SIGMA UNIV DL 15W-40 205LT	180 KG
ENI108330	ENI I-SIGMA UNIV DL 15W-40 60LT	48 KG
ENI108350	ENI I-SIGMA UNIV DL 15W-40 20LT	18 KG
ENI108392	ENI I-SIGMA UNIV DL 15W-40 6X4LT	-
ENI108410	ENI I-SIGMA UNIV 15W-40 205 LT	180 KG
ENI108430	ENI I-SIGMA UNIVERSAL 15W-40 60L FT	48 KG
ENI108450	ENI I-SIGMA UNIV 15W-40 20 LT	18 KG
ENI108492	ENI I-SIGMA UNIV 15W-40 6X4LT	-
ENI108510	ENI I-SIGMA UNIVER 10W-40 205LT	180 KG
ENI108530	ENI I-SIGMA UNIVER 10W-40 60LT	48 KG
ENI108550	ENI I-SIGMA UNIVER 10W-40 20LT	18 KG
ENI108592	ENI I-SIGMA UNIVER 10W-40 6X4LT	-
ENI108610	ENI I-SIGMA SPEC MB 10W-40 205LT	180 KG
ENI108650	ENI I-SIGMA SPEC MB 10W-40 20L	18 KG
ENI108710	ENI I-SIGMA MONOG 10W-20 205LT	180 KG
ENI108750	ENI I-SIGMA MONOG 10W-20 20 LT	18 KG
ENI108810	ENI I-SIGMA MONOGRADE 30 205LT	180 KG
ENI108830	ENI I-SIGMA MONOGRADE 30 60LT	48 KG
ENI108850	ENI I-SIGMA MONOGRADE 30 20LT	18 KG
ENI108892	ENI I-SIGMA MONOGRADE 30 6X4LT	-
ENI108910	ENI I-SIGMA MONOGRADE 40 205LT	180 KG
ENI108930	ENI I-SIGMA MONOGRADE 40 60LT	48 KG
ENI108950	ENI I-SIGMA MONOGRADE 40 20LT	18 KG
ENI108992	ENI I-SIGMA MONOGRADE 40 6X4LT	-
ENI109010	ENI I-SIGMA MONOGRADE 50 205LT	180 KG
ENI109030	ENI I-SIGMA MONOGRADE 50 60LT	48 KG
ENI109050	ENI I-SIGMA MONOGRADE 50 20LT SE	18 KG
ENI109610	ENI I-SIGMA PERFORMANCE E3 20W-50 205LT	180 KG
ENI109650	ENI I-SIGMA PERFORMANCE E3 20W-50 20 LT SE	18 KG
ENI109692	ENI I-SIGMA PERFORMANCE E3 20W-50 6X4LT TA	-
ENI109810	ENI I-SIGMA UNIVERSAL 20W-50 205L FS	180 KG
ENI109850	ENI I-SIGMA UNIVERSAL 20W-50 20LT SE	18 KG
ENI109891	ENI I-SIGMA UNIVERSAL 20W-50 12X1LT TA	-
ENI109892	ENI I-SIGMA UNIVERSAL 20W-50 6X4LT TA	-

**ENI - LINEA AGRICOLTURA**
*ENI - LINE AGRICULTURE*
*ENI - LINE AGRICULTURE*
*ENI - LINE LANDWIRTSCHAFT*
*ENI - LÍNEA DE AGRICULTURA*

Art./Ref.	Note/Note	Peso Kg/Weight Kg
ENI128110	ENI MULTITECH JD/F 10W-30 205L FS	180 KG
ENI128150	ENI MULTITECH JD/F 10W-30 20L SE	18 KG
ENI129210	ENI MULTITECH CT PLUS 10W 205 LT FS	180 KG
ENI129250	ENI MULTITECH CT PLUS 10W 20 LT SE	18 KG
ENI129410	ENI MULTITECH CT 30 205 LT FS	180 KG
ENI129450	ENI MULTITECH CT 30 20 LT SE	18 KG
ENI129510	ENI MULTITECH CT 50 205 LT FS	180 KG



Art./Ref.	Note/Note	Peso Kg/Weight Kg
ENI129550	ENI MULTITECH CT 50 20 LT SE	18 KG
ENI130010	ENI MULTITECH 10W-30 205 LT FS	180 KG
ENI130210	ENI MULTITECH 10W-40 205 LT FS	180 KG
ENI130410	ENI MULTITECH 15W-40 205 LT FS	180 KG
ENI130450	ENI MULTITECH 15W-40 60 LT FT	18 KG
ENI130492	ENI MULTITECH 15W-40 20 LT SE	18 KG
ENI142111	AGRIMOTOR 2T 180KG	180 KG
ENI142140	AGRIMOTOR 2T 18KG	18 KG
ENI142192	AGRIMOTOR 2T 6X4LT	-
ENI143440	SUPER 2T 18 KG	18 KG
ENI143911	ECO LUBE MS 180 KG	180 KG
ENI143940	ECO LUBE MS 18 KG	18 KG
ENI144011	OLIO X MOTOSEGHE 180 KG	180 KG
ENI144092	OLIO X MOTOSEGHE 6X4LT	-

**ENI - SPECIALITA' AUTO**

ENI - AUTO SPECIALITE'

ENI - SPECIALTY 'AUTO

ENI - SPEZIALITAT AUTO

ENI - AUTO ESPECIALIDAD'

Art./Ref.	Note/Note	Peso Kg/Weight Kg
ENI160918	ANTIFREEZE EXTRA 200 KG	200 KG
ENI160923	ANTIFREEZE EXTRA 850 KG	850 KG
ENI160948	ANTIFREEZE EXTRA 20 KG	20 KG
ENI160983	ANTIFREEZE EXTRA 12X1 LT	-
ENI161118	ANTIFREEZE READY 200 KG	200 KG
ENI161183	ANTIFREEZE READY 12x1 LT	-
ENI161218	ANTIFREEZE ECO READY 200 KG	200 KG
ENI161718	ANTIFREEZE ECO PLUS 200 KG	200 KG
ENI165204	BRAKE FLUID DOT 4 PLUS 24x1/4 LT	-
ENI165504	BRAKE FLUID DOT4 12X1 LT	-
ENI165519	BRAKE FLUID DOT4 210KG	210 KG
ENI165583	BRAKE FLUID DOT 4 12X1 LT	-
ENI517718	ANTIFREEZE SPEZIAL 200 KG	200 KG
ENI517748	ANTIFREEZE SPEZIAL 20 KG	20 KG
ENI517783	ANTIFREEZE SPEZIAL 12X1 LT	-
ENI744504	BRAKE FLUID DOT 4 1 24x1/4 LT	-
ENI793818	ANTIFREEZE PLUS 200 KG	200 KG
ENI793848	ANTIFREEZE PLUS 20 KG	20 KG

**ENI - OLI CAMBIO**

ENI - CHANGEMENT DE L'HUILE

ENI - OIL CHANGE

ENI - OIL CHANGE

ENI - CAMBIO DE ACEITE

Art./Ref.	Note/Note	Peso Kg/Weight Kg
ENI140891	GEAR 10W-40 12X1 LT	-
ENI130791	ENI ROTRA BIKE SYNTH 75W-90 12X1 LT TA	-
ENI144291	GEAR 5W-20 12X1 LT	-
ENI389691	GEAR 80W-90 12X1 LT	-
ENI140811	GEAR 10W-40 180 KG	180 KG

**ENI - OLI FORCELLE**

ENI - HUILES DE FOURCHE

ENI - FORK OILS

ENI - GABELOLE

ENI - ACEITES DE HORQUILLA

Art./Ref.	Note/Note
ENI142591	FORK 5W 12X1 LT
ENI142691	FORK 7,5W 12X1 LT
ENI142791	FORK 10W 12X1 LT
ENI142891	FORK 15W 12X1 LT

**ENI - LUBRIFICANTI PER CAMBI, DIFFERENZIALI E TRASMISSIONI**

ENI - LUBRIFIANTS POUR LE CHANGEMENT ET LA TRANSMISSION DIFFERENTIELLE

ENI - LUBRICANTS FOR CHANGE, AND DIFFERENTIAL TRANSMISSION

ENI - LUBRICANTS FÜR DEN WANDEL UND DIFFERENZUBERTRAGUNG

ENI - LUBRICANTES PARA EL CAMBIO Y DIFERENCIAL DE TRANSMISIÓN

Art./Ref.	Note/Note	Peso Kg/Weight Kg
ENI123210	ENI ROTRA HY/DB SYNTH 75W-90 205LT FS	180 KG
ENI123250	ENI ROTRA HY/DB SYNTH 75W-90 20LT SE	18 KG
ENI126710	ENI ROTRA ATF II E 205L FS	180 KG
ENI127310	ENI ROTRA MP/S 85W-90 205 LT FS	180 KG
ENI127350	ENI ROTRA MP/S 85W-90 20 LT SE	18 KG
ENI127410	ENI MULTITECH THT 15W-30 205 LT FS	180 KG
ENI127430	ENI MULTITECH THT 15W-30 60 LT FT	48 KG
ENI127450	ENI MULTITECH THT 15W-30 20 LT SE	18 KG
ENI127492	ENI MULTITECH THT 15W-30 6X4 LT TA	-
ENI127510	ENI ROTRA MP 80W-90 205 LT FS	180 KG
ENI127530	ENI ROTRA MP 80W-90 60 LT FT	48 KG
ENI127550	ENI ROTRA MP 80W-90 20 LT SE	18 KG
ENI127591	ENI ROTRA MP 80W-90 12X1 LT TA	-
ENI127592	ENI ROTRA MP 80W-90 6X4 LT TA	-
ENI127610	ENI ROTRA MP 85W-140 205 LT FS	180 KG
ENI127650	ENI ROTRA MP 85W-140 20 LT SE	18 KG
ENI127691	ENI ROTRA MP 85W-140 12X1 LT TA	-
ENI127692	ENI ROTRA MP 85W-140 6X4 LT TA	-
ENI127710	ENI ROTRA HY DB 80W 205 LT FS	180 KG
ENI127750	ENI ROTRA HY DB 80W 20 LT SE	18 KG
ENI127791	ENI ROTRA HY DB 80W 12X1 LT TA	-
ENI128210	ENI ROTRA HY 80W-90 205 LT FS	180 KG
ENI128250	ENI ROTRA HY 80W-90 20 LT SE	18 KG
ENI128310	ENI ROTRA MP DB 85W-90 205 LT FS	180 KG
ENI128350	ENI ROTRA MP DB 85W-90 20 LT SE	18 KG
ENI128410	ENI ROTRA 80W-90 205 LT FS	180 KG
ENI128450	ENI ROTRA 80W-90 20 LT SE	18 KG
ENI128491	ENI ROTRA 80W-90 12X1 LT TA	-
ENI128492	ENI ROTRA 80W-90 6X4 LT TA	-
ENI128510	ENI ROTRA 85W-140 205 LT FS	180 KG
ENI128550	ENI ROTRA 85W-140 20 LT SE	18 KG
ENI128591	ENI ROTRA 85W-140 12X1 LT TA	-
ENI128592	ENI ROTRA 85W-140 6X4 LT TA	-
ENI128810	ENI ROTRA TRUCK GEAR 80W-90 205 LT FS	180 KG
ENI128850	ENI ROTRA TRUCK GEAR 80W-90 20 LT SE	18 KG
ENI128910	ENI ROTRA TRUCK GEAR 85W-140 205 LT CV	180 KG
ENI128950	ENI ROTRA TRUCK GEAR 85W-140 20 LT SE	18 KG
ENI129010	ENI ROTRA LSX 75W-90 205 LT FS	180 KG
ENI129030	ENI ROTRA LSX 75W-90 60 LT FT	48 KG
ENI129050	ENI ROTRA LSX 75W-90 20 LT SE	18 KG
ENI129091	ENI ROTRA LSX 75W-90 12X1 LT TA	-
ENI129710	ENI ROTRA ATF II D 205L FS	180 KG

Art./Ref.	Note/Note	Peso Kg/Weight Kg
ENI129750	ENI ROTRA ATF II D 20 LT SE	18 KG
ENI129791	ENI ROTRA ATF II D 12X1 LT TA	-
ENI129810	ENI ROTRA ATF III 205L FS	-
ENI129850	ENI ROTRA ATF III 20 LT SE	18 KG
ENI129910	ENI ROTRA ATF 205 LT FS	180 KG
ENI129950	ENI ROTRA ATF 20 LT SE	18 KG
ENI131010	ENI ROTRA ATF MULTI 205 LT FS	180 KG
ENI131030	ENI ROTRA ATF MULTI 60 LT FT	48 KG
ENI131810	ENI ROTRA ATF VI 205 LT FS	180 KG
ENI131910	ENI ROTRA TRUCK GEAR 75W-140 205LT FS	180 KG
ENI131930	ENI ROTRA TRUCK GEAR 75W-140 60LT FS	48 KG

**ENI - MULTIFUNZIONALI SINTETICI**

ENI - POLYVALENTE SYNTHÉTIQUE

ENI - MULTIPURPOSE SYNTHETIC

ENI - MULTIPURPOSE SYNTHETISCHES

ENI - MULTIUSOS SINTÉTICO

Art./Ref.	Note/Note	Peso Kg/Weight Kg
ENI728312	DICREA SX 32 18 KG	170 KG
ENI728340	DICREA SX 32 18 KG	18 KG
ENI728212	DICREA SX 46 170 KG	170 KG
ENI728240	DICREA SX 46 18 KG	18 KG
ENI728412	DICREA SX 68 170 KG	170 KG
ENI728440	DICREA SX 68 18 KG	18 KG
ENI773912	BLASIA SX 100 170 KG	170 KG
ENI773923	BLASIA SX 100 850 KG	850 KG
ENI773940	BLASIA SX 100 18 KG	18 KG
ENI774012	BLASIA SX 150 170 KG	170 KG
ENI774023	BLASIA SX 150 850 KG	850 KG
ENI773712	BLASIA SX 220 170 KG	170 KG
ENI773740	BLASIA SX 220 18 KG	18 KG
ENI770611	BLASIA SX 320 180 KG	180 KG
ENI770640	BLASIA SX 320 18 KG	18 KG

**ENI - GRASSI AUTO**

ENI - GRAISSES AUTO

ENI - FATS AUTO

ENI - PKW-FETTE

ENI - GRASAS AUTO

Art./Ref.	Note/Note	Peso Kg/Weight Kg
ENI171625	GREASE 15 180KG	180 KG
ENI171654	GREASE 15 18KG	18 KG
ENI171676	GREASE 15 5KG	5 KG
ENI171925	GREASE 16 180KG	180 KG
ENI171954	GREASE 16 18KG	18 KG
ENI171976	GREASE 16 5KG	5 KG
ENI171988	GREASE 16 12X1KG	
ENI172094	MP GREASE SENZA POMPA 24X380 GR	
ENI172194	MP GREASE CON POMPA da 36x380 GR	
ENI174525	GREASE 30 2 180KG	180 KG
ENI174554	GREASE 30 2 18KG	18 KG
ENI174576	GREASE 30 2 5KG	5 KG
ENI174588	GREASE 30 2 12X1KG	
ENI176025	GREASE 33 FD 180KG	180 KG
ENI176054	GREASE 33 FD 20LT	18 KG
ENI176076	GREASE 33 FD 5KG	5 KG

**ENI - GRASSI INDUSTRIA PROTETTIVI**

ENI - GRAISSES INDUSTRIALS DE PROTECTION  
 ENI - FATS INDUSTRY PROTECTION  
 ENI - INDUSTRIEFETTE  
 ENI - GRASAS PROTECCION INDUSTRIALES

Art./Ref.	Note/Note	Peso Kg/Weight Kg
ENI464025	GREASE PV 2 180 KG	180 KG
ENI464054	GREASE PV 2 18 KG	18 KG
ENI525025	LITIO GREASE 475 180 KG	180 KG
ENI525054	LITIO GREASE 475 18 KG	18 KG

**ENI - GRASSI INDUSTRIA PER RIDUTTORI ED INGRANAGGI**

ENI - FATS INDUSTRIE ET PIGNON  
 ENI - FATS INDUSTRY FOR GEAR AND GEAR  
 ENI - FETTINDUSTRIE FÜR UND ZAHNRAD  
 ENI - GRASAS PARA INDUSTRIA Y ENGRANAJES

Art./Ref.	Note/Note	Peso Kg/Weight Kg
ENI467525	GREASE SLL/00 180 KG	180 KG
ENI467554	GREASE SLL/00 18 KG	18 KG
ENI470225	GREASE NG 3 180 KG	180 KG
ENI470254	GREASE NG 3 18 KG	18 KG
ENI471025	SAGUS 60 180 KG	180 KG
ENI471054	SAGUS 60 18 KG	18 KG

**ENI - GRASSI INDUSTRIA PER ALTE TEMPERATURE**

ENI - GRAISSES INDUSTRIALS POUR HAUTES TEMPERATURES  
 ENI - FATS INDUSTRY FOR HIGH TEMPERATURES  
 ENI - INDUSTRIEFETTE FUER HOHE TEMPERATUREN  
 ENI - GRASAS INDUSTRIALES DE ALTA TEMPERATURA

Art./Ref.	Note/Note	Peso Kg/Weight Kg
ENI466025	GREASE NF 2 180 KG	180 KG
ENI466054	GREASE NF 2 18 KG	18 KG
ENI467225	GREASE SM 2 180 KG	180 KG
ENI467254	GREASE SM 2 18 KG	18 KG
ENI524925	SILIS GREASE HTL 180 KG	180 KG
ENI524954	SILIS GREASE HTL 18 KG	18 KG
ENI119025	GREASE LC 1 180 KG	180 KG
ENI119054	GREASE LC 1 18 KG	18 KG
ENI119125	GREASE LC 2 180 KG	180 KG
ENI119154	GREASE LC 2 18 KG	18 KG
ENI717625	GREASE AC 1 180 KG	180 KG
ENI717654	GREASE AC 1 18 KG	18 KG
ENI717525	GREASE AC 2 180 KG	180 KG
ENI717554	GREASE AC 2 18 KG	18 KG
ENI464140	GREASE PHT 20 KG	20 KG

**ENI - GRASSI INDUSTRIA BIODEGRADABILI**

ENI - GRAISSES INDUSTRIALS BIODEGRADABLES  
 ENI - FATS INDUSTRY BIODEGRADABLE  
 ENI - INDUSTRIEFETTE BIOLOGISCH ABBAUBAR  
 ENI - GRASAS INDISTRIALES BIODEGRADABLES

Art./Ref.	Note/Note	Peso Kg/Weight Kg
ENI460325	ECO GREASE/O 180 KG	180 KG
ENI460354	ECO GREASE/O 18 KG	18 KG

**ENI - GRASSI INDUSTRIA AL CALCIO**

ENI - GRAISSES INDUSTRIE AU CALCIUM

ENI - CALCIUM INDUSTRY GREASE

ENI - KALZIUM-INDUSTRIEFETT

ENI - GRASAS INDUSTRIA BASADOS EN CALCIUM

Art./Ref.	Note/Note	Peso Kg/Weight Kg
ENI460525	GREASE CC 2 180 KG	180 KG
ENI460554	GREASE CC 2 18 KG	18 KG
ENI460625	GREASE CC 3 180 KG	180 KG
ENI460654	GREASE CC 3 18 KG	18 KG
ENI460725	GREASE CC 4 180 KG	180 KG
ENI460754	GREASE CC 4 18 KG	18 KG

**ENI - GRASSI INDUSTRIA MULTIFUNZIONALI AL LITIO**

ENI - GRAISSES INDUSTRIALS POLYVALENTS LITHIUM

ENI - FATS INDUSTRY MULTIPURPOSE LITHIUM

ENI - INDUSTRIEFETTE FUER LITHIUMGEHALT

ENI - GRASAS INDUSTRIALES MULTIUSO DE LITIO

Art./Ref.	Note/Note	Peso Kg/Weight Kg
ENI768025	SP GR MU 00 180 KG	180 KG
ENI768054	SP GR MU 00 18 KG	18 KG
ENI462525	GREASE MU 2 180 KG	180 KG
ENI462554	GREASE MU 2 18 KG	18 KG
ENI462625	GREASE MU 3 180 KG	180 KG
ENI462654	GREASE MU 3 18 KG	18 KG
ENI463525	GREASE MU EP 0 180 KG	180 KG
ENI463554	GREASE MU EP 0 18KG	18 KG
ENI463625	GREASE MU EP 1 180 KG	180 KG
ENI463654	GREASE MU EP 1 18KG	18 KG
ENI463725	GREASE MU EP 2 180 KG	180 KG
ENI463754	GREASE MU EP 2 18KG	18 KG
ENI463825	GREASE MU EP 3 180 KG	180 KG
ENI463854	GREASE MU EP 3 18 KG	18 KG
ENI497025	GREASE LP 0 180 KG	180 KG
ENI497054	GREASE LP 0 18 KG	18 KG
ENI497125	GREASE LP 1 180 KG	180 KG
ENI497154	GREASE LP 1 18 KG	18 KG
ENI497225	GREASE LP 2 180 KG	180 KG
ENI497254	GREASE LP 2 18 KG	18 KG

**ENI - BIANCHI**

ENI - BLANC

ENI - WHITE

ENI - WHITE

ENI - BLANCO

Art./Ref.	Note/Note	Peso Kg/Weight Kg
ENI450011	OBI 10 180 KG	180 KG
ENI450040	OBI 10 18 KG	18 KG
ENI451011	OBI 12 180 KG	180 KG
ENI451040	OBI 12 18 KG	18 KG
ENI452011	OBI T 13 180 KG	180 KG
ENI452040	OBI T 13 18 KG	18 KG
ENI450023	OBI 10 850 KG	850 KG
ENI451023	OBI 12 850 KG	850 KG

**ENI - TURBINE E TURBOCOMPRESSORI**

ENI - TURBINE TURBOCOMPRESSEURS  
 ENI - TURBINE TURBOCHARGERS  
 ENI - TURBINE TURBOLADER  
 ENI - TURBINE TURBOCOMPRESORES

Art./Ref.	Note/Note	Peso Kg/Weight Kg
ENI261011	OTE 32 180 KG	180 KG
ENI261040	OTE 32 18 KG	18 KG
ENI261111	OTE 46 180 KG	180 KG
ENI261140	OTE 46 18 KG	18 KG
ENI261211	OTE 68 180 KG	180 KG
ENI261240	OTE 68 18 KG	18 KG
ENI261311	OTE 80 180 KG	180 KG
ENI261340	OTE 80 18 KG	18 KG
ENI261411	OTE 100 180 KG	180 KG
ENI261440	OTE 100 18 KG	18 KG
ENI775512	OTE 32 GT 170 KG	170 KG
ENI261611	OTE 46 GT 180 KG	180 KG
ENI718411	OTE TC 46 180 KG	180 KG
ENI261023	OTE 32 850 KG	850 KG
ENI261123	OTE 46 850 KG	850 KG
ENI261223	OTE 68 850 KG	850 KG
ENI261423	OTE 100 850 KG	850 KG
ENI261623	OTE 46 GT 850 KG	850 KG
ENI775523	OTE 32 GT 850 KG	850 KG

**ENI - SISTEMI IDRAULICI A CIRCOLAZIONE**

ENI - SYSTEME HYDRAULIQUE A MOUVEMENT  
 ENI - HYDRAULIC SYSTEMS A MOVEMENT  
 ENI - ÖLVERSORGUNGSANLAGE A BEWEGUNG  
 ENI - SISTEMAS HIDRÁULICOS UN MOVIMIENTO

Art./Ref.	Note/Note	Peso Kg/Weight Kg
ENI700712	ACER MV 10 170 KG	170 KG
ENI700740	ACER MV 10 18 KG	18 KG
ENI215112	ACER 15 170 KG	170 KG
ENI215140	ACER 15 18 KG	18 KG
ENI216012	ACER 22 170 KG	170 KG
ENI216040	ACER 22 18 KG	18 KG
ENI216111	ACER 32 180 KG	180 KG
ENI216140	ACER 32 18 KG	18 KG
ENI216211	ACER 46 180 KG	180 KG
ENI216240	ACER 46 18 KG	18 KG
ENI216311	ACER 68 180 KG	180 KG
ENI216340	ACER 68 18 KG	18 KG
ENI216411	ACER 100 180 KG	180 KG
ENI216440	ACER 100 18 KG	18 KG
ENI216511	ACER 150 180 KG	180 KG
ENI216540	ACER 150 18 KG	18 KG
ENI215211	ACER 220 180 KG	180 KG
ENI215240	ACER 220 18 KG	18 KG
ENI215311	ACER 320 180 KG	180 KG
ENI215340	ACER 320 18 KG	18 KG
ENI215411	ACER 460 180 KG	180 KG
ENI215440	ACER 460 18 KG	18 KG

Art./Ref.	Note/Note	Peso Kg/Weight Kg
ENI526511	ACER 680 180 KG	180 KG
ENI215511	ACER 800 180 KG	180 KG
ENI215540	ACER 800 18 KG	18 KG
ENI230112	OSO 15 170 KG	170 KG
ENI230140	OSO 15 18 KG	18 KG
ENI231611	OSO 22 180 KG	180 KG
ENI231640	OSO 22 18 KG	18 KG
ENI230211	OSO 32 180 KG	180 KG
ENI230240	OSO 32 18 KG	18 KG
ENI230311	OSO 46 180KG	180 KG
ENI230340	OSO 46 18KG	18 KG
ENI230440	OSO 68 18 KG	18 KG
ENI230511	OSO 100 180 KG	180 KG
ENI230540	OSO 100 18 KG	18 KG
ENI230611	OSO 150 180 KG	180 KG
ENI230640	OSO 150 18 KG	18 KG
ENI742411	OSO 5 46 180 KG	180 KG
ENI253012	ARNICA 22 170 KG	170 KG
ENI253040	ARNICA 22 18 KG	18 KG
ENI253111	ARNICA 32 180 KG	180 KG
ENI253140	ARNICA 32 18 KG	18 KG
ENI253211	ARNICA 46 180 KG	180 KG
ENI253240	ARNICA 46 18 KG	18 KG
ENI253311	ARNICA 68 180 KG	180 KG
ENI253340	ARNICA 68 18 KG	18 KG
ENI253411	ARNICA 100 180 KG	180 KG
ENI258018	ARNICA 104/FR 200 KG	200 KG
ENI258040	ARNICA 104/FR 18 KG	18 KG
ENI256011	ARNICA 5/46 180 KG	180 KG
ENI256111	ARNICA 5/68 180 KG	180 KG
ENI230323	OSO 46 850KG	850 KG
ENI230392	OSO 46 6X4LT	
ENI215223	ACER 220 850 KG	850 KG
ENI215323	ACER 320 850 KG	850 KG
ENI215423	ACER 460 850 KG	850 KG
ENI215523	ACER 800 850 KG	850 KG
ENI216023	ACER 22 850 KG	850 KG
ENI216123	ACER 32 850 KG	850 KG
ENI216223	ACER 46 850 KG	850 KG
ENI216323	ACER 68 850 KG	850 KG
ENI216423	ACER 100 850 KG	850 KG
ENI216523	ACER 150 850 KG	850 KG
ENI230223	OSO 32 850 KG	850 KG
ENI230423	OSO 68 850 KG	850 KG
ENI230523	OSO 100 850 KG	850 KG
ENI230623	OSO 150 850 KG	850 KG
ENI231623	OSO 22 850 KG	850 KG
ENI253023	ARNICA 22 850 KG	850 KG
ENI253123	ARNICA 32 850 KG	850 KG
ENI253223	ARNICA 46 850 KG	850 KG
ENI253323	ARNICA 68 850 KG	850 KG
ENI256023	ARNICA 5/46 850 KG	850 KG
ENI256123	ARNICA 5/68 850 KG	850 KG
ENI742423	OSO 5 46 850 KG	850 KG

**ENI - LUBRIFICANTE PER SOSPENSIONI**

ENI - LUBRIFIANT POUR SUSPENSION  
 ENI - LUBRICANT FOR SUSPENSION  
 ENI - SCHMIERMITTEL FÜR SUSPENSION  
 ENI - LUBRICANTE PARA SUSPENSION

Art./Ref.	Note/Note	Peso Kg/Weight Kg
ENI150012	LHM SUPER 170KG	170 KG
ENI150091	LHM SUPER 12X1LT	

**ENI - LUBRIFICAZIONE GENERALE**

ENI - LE GRAISSAGE GENERAL  
 ENI - GENERAL LUBRICATION  
 ENI - ALLGEMEINE SCHMIERUNG  
 ENI - LUBRICACIÓN GENERAL

Art./Ref.	Note/Note	Peso Kg/Weight Kg
ENI332011	ASP 100 180 KG	180 KG
ENI332040	ASP 100 20 LT	18 KG
ENI332111	ASP 150 180 KG	180 KG
ENI332140	ASP 150 20 LT	18 KG
ENI332211	ASP 220 180 KG	180 KG
ENI332240	ASP 220 20 LT	18 KG
ENI213212	RADULA 32 170 KG	170 KG
ENI213240	RADULA 32 18 KG	18 KG
ENI213311	RADULA 46 180 KG	180 KG
ENI213340	RADULA 46 18 KG	18 KG
ENI213223	RADULA 32 850 KG	850 KG
ENI213323	RADULA 46 850 KG	850 KG

**ENI - INGRANAGGI E RIDUTTORI**

ENI - GEARS ET VITESSE  
 ENI - GEARS AND GEAR  
 ENI - ZAHNRADER UND GETRIEBEBAU  
 ENI - ENGRANAJES Y

Art./Ref.	Note/Note	Peso Kg/Weight Kg
ENI270011	BLASIA 68 180 KG	180 KG
ENI270040	BLASIA 68 18 KG	18 KG
ENI270111	BLASIA 100 180 KG	180 KG
ENI270140	BLASIA 100 18 KG	18 KG
ENI270211	BLASIA 150 180 KG	180 KG
ENI270240	BLASIA 150 18KG	18 KG
ENI270311	BLASIA 220 180 KG	180 KG
ENI270340	BLASIA 220 18 KG	18 KG
ENI270411	BLASIA 320 180 KG	180 KG
ENI270440	BLASIA 320 18 KG	18 KG
ENI270511	BLASIA 460 180 KG	180 KG
ENI270540	BLASIA 460 18 KG	18 KG
ENI270611	BLASIA 680 180 KG	180 KG
ENI270640	BLASIA 680 18 KG	18 KG
ENI771011	BLASIA P 1000 180 KG	180 KG



Art./Ref.	Note/Note	Peso Kg/Weight Kg
ENI771040	BLASIA P 1000 18 KG	18 KG
ENI771311	BLASIA P 2200 180 KG	180 KG
ENI270823	BLASIA BM 220 850 KG	850 KG
ENI277011	BLASIA S 150 180 KG	180 KG
ENI277040	BLASIA S 150 20 LT	18 KG
ENI278011	BLASIA S 220 180 KG	180 KG
ENI278040	BLASIA S 220 18 KG	18 KG
ENI771411	BLASIA S 320 180 KG	180 KG
ENI771440	BLASIA S 320 18 KG	18 KG
ENI771211	BLASIA S 460 180 KG	180 KG
ENI771240	BLASIA S 460 18 KG	18 KG
ENI734511	ARUM HT 220 180 KG	180 KG
ENI270023	BLASIA 68 850 KG	850 KG
ENI270123	BLASIA 100 850 KG	850 KG
ENI270223	BLASIA 150 850 KG	850 KG
ENI270323	BLASIA 220 850 KG	850 KG
ENI270423	BLASIA 320 850 KG	850 KG
ENI270523	BLASIA 460 850 KG	850 KG
ENI270623	BLASIA 680 850 KG	850 KG

**ENI - GUIDE E SLITTE**

ENI - GUIDES ET GLISSIÈRES

ENI - GUIDES AND SLIDES

ENI - GUIDES UND DIAS

ENI - GUÍAS Y DIAPOSITIVAS

Art./Ref.	Note/Note	Peso Kg/Weight Kg
ENI340311	EXIDIA HG 32 180 KG	180 KG
ENI340340	EXIDIA HG 32 18 KG	18 KG
ENI340411	EXIDIA HG 68 180 KG	180 KG
ENI340440	EXIDIA HG 68 18 KG	18 KG
ENI340511	EXIDIA HG 220 180 KG	180 KG
ENI340540	EXIDIA HG 220 18 KG	18 KG
ENI340323	EXIDIA HG 32 850 KG	850 KG
ENI340423	EXIDIA HG 68 850 KG	850 KG
ENI340523	EXIDIA HG 220 850 KG	850 KG

**ENI - FUNI ED INGRANAGGI SCOPERTI**

ENI - CORDES ET ENGS DÉCOUVERT

ENI - ROPES AND GEAR DISCOVERED

ENI - SEILE UND GEAR-ENTDECKT

ENI - CUERDAS Y ARTES ENCONTRADAS

Art./Ref.	Note/Note	Peso Kg/Weight Kg
ENI486311	FIN 332/F 180KG	180 KG
ENI486340	FIN 332/F 20 LT	18 KG
ENI486411	FIN 360/EP F 180 KG	180 KG
ENI486440	FIN 360/EP F 20 LT	18 KG

**ENI - COMPRESSORI**

ENI - COMPRESSEURS  
 ENI - COMPRESSORS  
 ENI - COMPRESSORS  
 ENI - COMPRESORES

Art./Ref.	Note/Note	Peso Kg/Weight Kg
ENI279111	BETULA 32 180 KG	180 KG
ENI279140	BETULA 32 18 KG	18 KG
ENI279211	BETULA 46 180 KG	180 KG
ENI279240	BETULA 46 18 KG	18 KG
ENI279311	BETULA 68 180 KG	180 KG
ENI279340	BETULA 68 18 KG	18 KG
ENI705414	BETULA S 32 170 KG	170 KG
ENI705440	BETULA S 32 18 KG	18 KG
ENI705614	BETULA S 68 170 KG	170 KG
ENI705640	BETULA S 68 18 KG	18 KG
ENI705714	BETULA S 100 170 KG	170 KG
ENI705740	BETULA S 100 18 KG	18 KG
ENI282011	DICREA 32 180 KG	180 KG
ENI282040	DICREA 32 18 KG	18 KG
ENI282111	DICREA 46 180 KG	180 KG
ENI282140	DICREA 46 18 KG	18 KG
ENI280011	DICREA 68 180 KG	180 KG
ENI280040	DICREA 68 18 KG	18 KG
ENI280111	DICREA 100 180 KG	180 KG
ENI280140	DICREA 100 18 KG	18 KG
ENI280211	DICREA 150 180 KG	180 KG
ENI280240	DICREA 150 18 KG	18 KG
ENI280311	DICREA 220 180 KG	180 KG
ENI280340	DICREA 220 18 KG	18 KG
ENI280511	DICREA 320 180 KG	180 KG
ENI280540	DICREA 320 18 KG	18 KG
ENI709119	DICREA S 150 210 KG	210 KG
ENI728811	DICREA ESX 100 180 KG	180 KG
ENI728840	DICREA ESX 100 18 KG	18 KG
ENI212111	SIC C 150 180 KG	180 KG
ENI212211	SIC C 220 180 KG	180 KG
ENI212223	SIC C 220 850 KG	850 KG
ENI279323	BETULA 68 850 KG	850 KG
ENI280223	DICREA 150 850 KG	850 KG
ENI280323	DICREA 220 850 KG	850 KG

**ENI - UTENSILI PNEUMATICI**

ENI - AIR TOOLS  
 ENI - AIR TOOLS  
 ENI - DRUCKLUFTWERKZEUGE  
 ENI - AIRE HERRAMIENTAS

Art./Ref.	Note/Note	Peso Kg/Weight Kg
ENI320011	ASP C 32 180 KG	180 KG
ENI320040	ASP C 32 18 KG	18 KG
ENI320111	ASP C 100 180 KG	180 KG
ENI320140	ASP C 100 18 KG	18 KG